

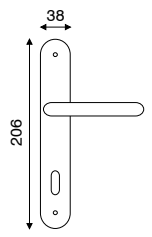

serie **OMEGA**



art. MA 2.1910
guarnitura con placca

FINITURA	ALL. BR	ALL. ARG	ALL. ORO
IMBALLO	10	10	10

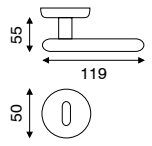

art. MA 2.1968
guarnitura rosetta e bocchetta
ø 50 mm a pressione

FINITURA	ALL. BR	ALL. ARG	ALL. ORO
IMBALLO	10	10	10

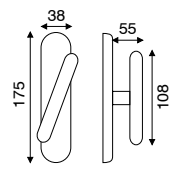

art. FI 2.1910
cremonese o martellina

FINITURA	ALL. BR	ALL. ARG	ALL. ORO
IMBALLO	10	10	10

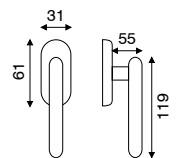

art. FI 2.1960
dk movimento in fibra

FINITURA	ALL. BR	ALL. ARG	ALL. ORO
IMBALLO	10	10	10

3150 Serie
THEA

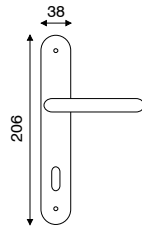

art. 1.6410

guarnitura con placca

FINITURA	ALL. BR	ALL. ARG	ALL. ORO
IMBALLO	10	10	10

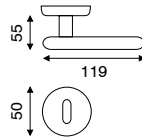

art. 1.6468

guarnitura rosetta e bocchetta
ø 50 mm a pressione

FINITURA	ALL. BR	ALL. ARG	ALL. ORO
IMBALLO	10	10	10

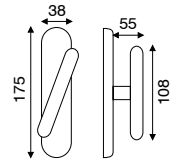

art. 4.6410

cremonese o martellina

FINITURA	ALL. BR	ALL. ARG	ALL. ORO
IMBALLO	10	10	10

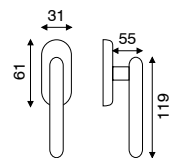

art. 4.6460

dk movimento in fibra

FINITURA	ALL. BR	ALL. ARG	ALL. ORO
IMBALLO	10	10	10

sns Serie **LINEA ACCIAIO INOX**

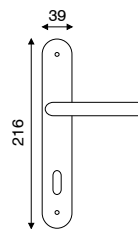
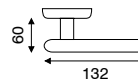

art. I.4810
guarnitura con placca

FINITURA	ACC. SAT
IMBALLO	1

sns Serie **OLARIX**

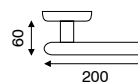

art. MA 2.4060
guarnitura rosetta e bocchetta
ø 50 mm a pressione

FINITURA	ACC. SAT
IMBALLO	1

sns Serie **OLARIX XL**



sns Serie **CAPRIX**

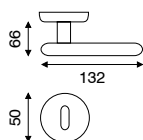

art. 1.8368
guarnitura rosetta e bocchetta
ø 50 mm a pressione

FINITURA	ACC. SAT
IMBALLO	1

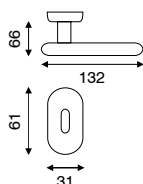

art. 1.8363
guarnitura rosetta e bocchetta
ovale 31x61 mm

FINITURA	ACC. SAT
IMBALLO	1

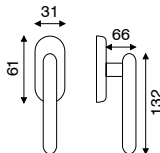

art. 4.8360
dk movimento in fibra

FINITURA	ACC. SAT
IMBALLO	2



sns Serie **OLARIX**

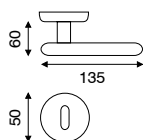

art. 1.4868
guarnitura rosetta e bocchetta
ø 50 mm a pressione

FINITURA	ACC. SAT
IMBALLO	1

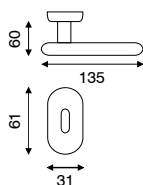

art. 1.4863
guarnitura rosetta e bocchetta
ovale 31x61 mm

FINITURA	ACC. SAT
IMBALLO	1

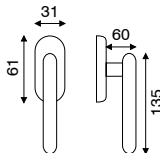

art. 4.4860
dk movimento in fibra

FINITURA	ACC. SAT
IMBALLO	2



sns Serie **NOVANTA**

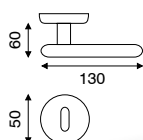

art. MA 2.1468
guarnitura rosetta e bocchetta
ø 50 mm a pressione

FINITURA	ACC. SAT
IMBALLO	1

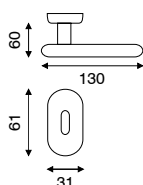

art. MA 2.1463
guarnitura rosetta e bocchetta
ovale 31x61 mm

FINITURA	ACC. SAT
IMBALLO	1

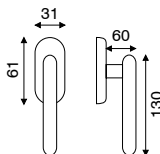

art. FI 2.1460
dk movimento in fibra

FINITURA	ACC. SAT
IMBALLO	2



5152 Serie **CORUS**

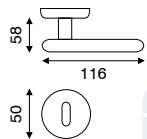

art. MA 2.3668

guarnitura rosetta e bocchetta in metallo
 ø 50 mm a pressione

FINITURA	ACC. LUC/SAT
IMBALLO	1

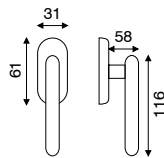

art. FI 2.3660

dk movimento in fibra

FINITURA	ACC. LUC/SAT
IMBALLO	2



5152 Serie **CRIS**

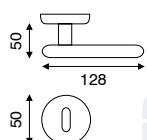

art. MA 2.3468

guarnitura rosetta e bocchetta in metallo
 ø 50 mm a pressione

FINITURA	ACC. LUC/SAT
IMBALLO	1

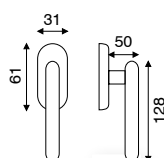

art. FI 2.3460

dk movimento in fibra

FINITURA	ACC. LUC/SAT
IMBALLO	2

**art. 3.2955**

maniglia incasso ovale
est. 120x40 mm - int. 92x28 mm

FINITURA	ACC. SAT
IMBALLO	12

**art. 3.2740**

maniglia incasso tonda
est. ø 65 mm - int. ø 50 mm

FINITURA	ACC. SAT
IMBALLO	12

**art. 3.2870**

coppia nottolino wc
con rosetta ø 50 mm a pressione

FINITURA	ACC. SAT
IMBALLO	5

**art. 3.2870/LO**

coppia nottolino wc con visualizzatore
con rosetta ø 50 mm a pressione

FINITURA	ACC. SAT
IMBALLO	5

**art. 3.2500.09**

maniglia bastoncino ø 10x96 mm

FINITURA	ACC. SAT
IMBALLO	25

LINEA PLASTICA

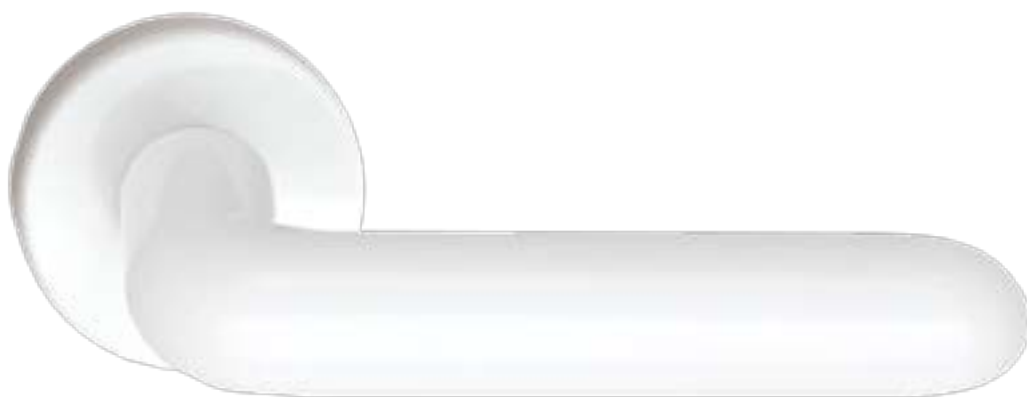

MARE

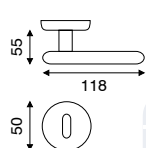

art. 1.0460

guarnitura rosetta e bocchetta in plastica
 ø 50 mm a pressione

FINITURA	BN	NR
IMBALLO	10	10

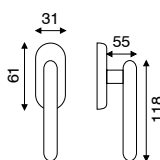

art. 4.0460

dk movimento in fibra

FINITURA	BN	NR
IMBALLO	10	10



MOON

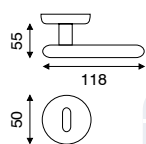

art. 1.0470

guarnitura rosetta e bocchetta in plastica
 ø 50 mm a pressione

FINITURA	BN	NR
IMBALLO	10	10

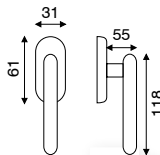

art. 4.0470

dk movimento in fibra

FINITURA	BN	NR
IMBALLO	10	10

**art. 3.2100**

pomolo fisso
ø 75 mm - perno passante

FINITURA	BN	NR
IMBALLO	12	12

**art. 3.2470**

portabito tondo

FINITURA	BN	NR
IMBALLO	12	12

**art. 3.2475**

portabito Arco

FINITURA	BN	NR
IMBALLO	12	12

**art. 3.2866**

coppia nottolini wc Q6
con rosetta ø 50 mm a pressione

FINITURA	BN	NR
IMBALLO	10	10

LINEA HOTEL



art. CHV 1.01801

GRT ingresso universale
con placca stretta 230x38 mm

FINITURA	OLV
IMBALLO	1



art. CHV 3.01801

GRT ingresso universale
con placca 278x56 mm

FINITURA	OLV
IMBALLO	4



art. CHV 3.01801 VC

GRT ingresso con visualizzatore di presenza per
sistema tipo CISA con placca stretta 278x56 mm

art. CHV 3.01801 VY

GRT ingresso con visualizzatore di presenza per
sistema tipo YALE con placca 278x56 mm

FINITURA	OLV
IMBALLO	1

AL PREZZO INDICATO VA AGGIUNTO IL COSTO DEL MODELLO DELLA MANIGLIA SCELTA



art. 4.1120

segretino Vega
con rosetta ovale e vita a vista - \varnothing 7 mm

FINITURA	OLV	OGR	CRS
IMBALLO	6	6	6



art. 4.1320

segretino Altwien
con rosetta ovale e vita a vista - \varnothing 7 mm

FINITURA	OLV	OGR	CRS
IMBALLO	6	6	6



art. 4.6720

segretino Elegant
con rosetta ovale e vita a vista - \varnothing 7 mm

FINITURA	OLV	OGR	CRS
IMBALLO	6	6	6



art. 4.1120.70

mini martellina Vega
con rosetta ovale e vita a vista
int. 43 mm

FINITURA	OLV	OGR	CRS
IMBALLO	6	6	6



art. 4.1320.70

mini martellina Altwien
con rosetta ovale e vita a vista
int. 43 mm

FINITURA	OLV	OGR	CRS
IMBALLO	6	6	6



art. 4.6720.70

mini martellina Elegant
con rosetta ovale e vita a vista
int. 43 mm

FINITURA	OLV	OGR	CRS
IMBALLO	6	6	6



art. 4.0110

martellina universale
con rosetta ovale e vita a vista
int. 43 mm

FINITURA	OLV	OGR	ANT
IMBALLO	6	6	6



art. 4.2263.70

martellina Alice
con rosetta ovale e vita a vista
int. 43 mm

FINITURA	OLV	OGR	CRS
IMBALLO	6	6	6



art. 4.2663.70

martellina Praga
con rosetta ovale e vita a vista
int. 43 mm

FINITURA	OLV	OGR	CRS
IMBALLO	6	6	6



art. 4.2963.70

martellina Venezia
con rosetta ovale e vita a vista
int. 43 mm

FINITURA	OLV	OGR	CRS
IMBALLO	6	6	6



art. 4.3363.70

martellina Malaga
con rosetta ovale e vita a vista
int. 43 mm

FINITURA	OLV	OGR	CRS
IMBALLO	6	6	6



art. 4.6063.70

martellina Gemma
con rosetta ovale e vita a vista
int. 43 mm

FINITURA	OLV	OGR	CRS
IMBALLO	6	6	6

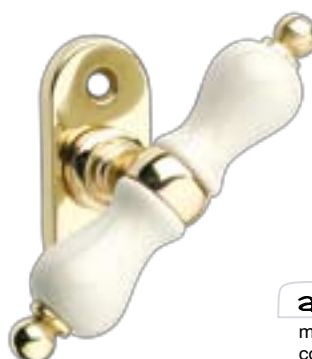

art. 4.6163.70

martellina Lara
con rosetta ovale e vita a vista
int. 43 mm

FINITURA	OLV	OGR	CRS
IMBALLO	6	6	6



art. 4.6363.70

martellina Eva
con rosetta ovale e vita a vista
int. 43 mm

FINITURA	OLV	OGR	CRS
IMBALLO	6	6	6



art. 4.8463.70

martellina Miriam
con rosetta ovale e vita a vista
int. 43 mm

FINITURA	OLV	OGR	CRS
IMBALLO	6	6	6



art. 4.8763.70

martellina Drò
con rosetta ovale e vita a vista
int. 43 mm

FINITURA	OLV	OGR	CRS
IMBALLO	6	6	6



art. 2.9025

bocchetta artistica
ø 45 mm - viti in vista con foro chiave

FINITURA	OLV	ANT	ARG ANT	CR
IMBALLO	30	30	30	30



art. 2.9025.18

bocchetta artistica
ø 50 mm - viti in vista con foro cilindro

FINITURA	OLV	ANT	ARG ANT	CR	CRS
IMBALLO	10	10	10	10	10



art. 2.9030.18

bocchetta coprivite
ø 50 mm ad avvitare con foro cilindro

art. 2.9030

bocchetta coprivite
ø 50 mm ad avvitare con foro asola

FINITURA	OLV	OGR	ANT	CR	CRS
IMBALLO	10	10	10	10	10



art. 2.9030.32

bocchetta coprivite
ø 50 mm ad avvitare senza foro

FINITURA	OLV	OGR	ANT	CR	CRS
IMBALLO	10	10	10	10	10



art. 2.9035.18

bocchetta coprivite
ø 45 mm a pressione con foro cilindro

art. 2.9035

bocchetta coprivite
ø 45 mm a pressione con foro asola

FINITURA	OLV	OGR	ANT	CR	CRS
IMBALLO	10	10	10	10	10



art. 2.9040.18

bocchetta coprivite ovale
62x30 mm con foro cilindro

art. 2.9040

bocchetta coprivite ovale
62x30 mm con foro asola

FINITURA	OLV	OGR	SAT	CR	CRS
IMBALLO	10	10	10	10	10



art. 2.9045

bocchetta lux
ø 45 mm ad avvitare con foro asola

FINITURA	OLV	ANT	CRS
IMBALLO	10	10	10



art. 2.9070.18

bocchetta coprivite bombata
ø 50 mm ad avvitare con foro cilindro

art. 2.9070

bocchetta coprivite bombata
ø 50 mm ad avvitare con foro asola

FINITURA	OLV	OGR	ANT	CR	CRS
IMBALLO	10	10	10	10	10



art. 2.9080

bocchetta liscia
ø 32 mm con viti in vista - foro asola

FINITURA	OLV
IMBALLO	30



art. 2.9085

bocchetta decorata
ø 32 mm con viti in vista - foro asola

FINITURA	OLV
IMBALLO	30



art. 2.9130.18

bocchetta coprivite in fibra
ø 50 mm a pressione con foro cilindro

art. 2.9130

bocchetta coprivite in fibra
ø 50 mm a pressione con foro asola

FINITURA	BN	NR
IMBALLO	30	30

**art. 2.9150.18**

bocchetta coprivite
 ø 50 mm a pressione con foro cilindro

art. 2.9150

bocchetta coprivite
 ø 50 mm a pressione con foro asola

FINITURA	ACC. SAT
IMBALLO	12

**art. 2.9155.18**

bocchetta coprivite ovale
 62x30 mm a pressione con foro cilindro

art. 2.9155

bocchetta coprivite ovale
 62x30 mm a pressione con foro asola

FINITURA	ACC. SAT
IMBALLO	25

**art. 2.9165**

bocchetta coprivite rettangolare
 61x31 mm con foro asola

FINITURA	OLV	OGR	CRS
IMBALLO	12	12	12

**art. 2.9165.18**

bocchetta coprivite rettangolare
 61x31 mm con foro cilindro

FINITURA	OLV	OGR	CRS
IMBALLO	12	12	12

**art. 2.9210**

bocchetta coprivite quadrata
 45x45 mm con foro asola

FINITURA	OLV	OGR	CRS
IMBALLO	12	12	12

**art. 2.9210.18**

bocchetta coprivite quadrata
 45x45 mm con foro cilindro

FINITURA	OLV	OGR	CRS
IMBALLO	12	12	12



art. 2.9170.18

bocchetta tonda
 ø 50 mm a pressione con foro yale

art. 2.9170

bocchetta coprivate
 ø 50 mm a pressione con foro asola

FINITURA	ALL. BZ	ALL. ARG
IMBALLO	30	30



art. 2.9200.18

bocchetta quadra
 50x50 mm con foro cilindro

art. 2.9200

bocchetta quadra
 50x50 mm con foro asola

FINITURA	OLV	OGR	CRS
IMBALLO	10	10	10



art. 2.9180.18

bocchetta coprivate con bordo
 ø 50 mm ad avvitare con foro cilindro

art. 2.9180

bocchetta coprivate con bordo
 ø 50 mm ad avvitare con foro asola

FINITURA	OLV	OGR	ORO ANT
IMBALLO	10	10	10



art. 2.9160.18

bocchetta coprivate tonda
 ø 50 mm con viti in vista e foro cilindro

FINITURA	FERRO NR
IMBALLO	20



art. 2.9005

rosetta foro ø 16 mm possibile montaggio con molla
 ø 65 mm ad avvitare

FINITURA	OLV	OGR	SAT	CR	CRS	NIK MATT
IMBALLO	6	6	6	6	6	6

serie COPPIA NOTTOLINI WC



art. 3.2850

coppia nottolino wc con rosetta
 ø 50 mm ad avvitare con imp. pesante

FINITURA	OLV	ANT	CRS
IMBALLO	5	5	5

art. 3.2860

coppia nottolino wc
 con rosetta ø 50 mm ad avvitare

FINITURA	OLV	ANT	CRS
IMBALLO	5	5	5



art. 3.2861

coppia nottolino wc
 con rosetta ø 45 mm a pressione

FINITURA	OLV	ANT	CRS
IMBALLO	5	5	5

art. 3.2861/LO

coppia nottolino wc con visualizzatore
 rosetta ø 45 mm a pressione

FINITURA	OLV	ANT	CRS
IMBALLO	5	5	5



art. 3.2872

coppia nottolino wc
 con rosetta ø 32 mm ad avvitare

FINITURA	OLV	ANT	CRS
IMBALLO	5	5	5



art. 3.2870

coppia nottolino wc
con rosetta ø 50 mm a pressione

FINITURA	ACC. SAT
IMBALLO	5



art. 3.2870/LO

coppia nottolino wc con visualizzatore
con rosetta ø 50 mm a pressione

FINITURA	ACC. SAT
IMBALLO	5



art. 3.2873

coppia nottolino wc
con rosetta quadra 50x50 mm

FINITURA	OLV	OGR	CRS
IMBALLO	2	2	2



art. 3.2874

coppia nottolino wc
con rosetta quadra 35x35 mm

FINITURA	OLV	OGR	CRS
IMBALLO	2	2	2



art. 3.2866

coppia nottolino wc
con rosetta ø 50 mm a pressione

FINITURA	BN	NR
IMBALLO	10	10



art. 3.2701

maniglia ad incasso tonda "senza foro chiave"

MISURA	ø 26x12 mm	ø 30x12 mm	ø 35x12 mm	ø 40x12 mm
FINITURA	OLV	OLV	OLV	OLV
IMBALLO	20	20	20	20
FINITURA	OGR	OGR	OGR	OGR
FINITURA	CR	CR	CR	CR
FINITURA	CRS	CRS	CRS	CRS



art. 3.2702

maniglia ad incasso tonda
ø 57x12 mm - per foro 48 mm
"foro chiave"

FINITURA	OLV	OGR	CR	CRS
IMBALLO	12	12	12	12



art. 3.2703

maniglia ad incasso tonda
ø 57x12 mm - per foro 48 mm
"senza foro"

FINITURA	OLV	OGR	CR	CRS
IMBALLO	12	12	12	12



art. 3.2704

maniglia ad incasso tonda
ø 57x12 mm - per foro 48 mm
"foro yale"

FINITURA	OLV	OGR	CR	CRS
IMBALLO	12	12	12	12



art. 3.2703 FE

maniglia ad incasso tonda
ø 57x12 mm - per foro 48 mm
"senza foro"

art. 3.2702 FE

maniglia ad incasso tonda
ø 57x12 mm - per foro 48 mm
"foro chiave"

FINITURA	ORO	BR	CRS
IMBALLO	12	12	12



art. 3.2710

maniglia ad incasso tonda
ø 57x12 mm - per foro 48 mm
"semichiusa"

FINITURA	OLV	OGR	SAT	CR	CRS
IMBALLO	12	12	12	12	12



art. 3.2720

maniglia ad incasso quadra
52x52 mm h. 12 mm
per foro 48 mm - "senza foro"

FINITURA	OLV	OGR	SAT	CR	CRS
IMBALLO	12	12	12	12	12



art. 3.2750

coppia maniglia ad incasso tonda
 ø 57x12 mm - per foro 48 mm "nottolino wc"

FINITURA	OLV	OGR	CR	CRS
IMBALLO	4	4	4	4



art. 3.2750 FE

coppia maniglia ad incasso tonda ø 57x12 mm
 per foro 48 mm "nottolino wc" - **in laminato**

FINITURA	ORO	BR	CRS
IMBALLO	4	4	4



art. 3.2790

coppia maniglia ad incasso quadra
 52x52 mm - per foro 48 mm "nottolino wc"

FINITURA	OLV	OGR	CR	CRS
IMBALLO	4	4	4	4



art. 3.2770

coppia maniglia ad incasso tonda ø 57x12 mm
 per foro 48 mm - con pendente e gettone

FINITURA	OLV	OGR	SAT	CR	CRS
IMBALLO	4	4	4	4	4



art. 3.2771

coppia maniglia ad incasso tonda
 ø 57x12 mm - per foro 48 mm - con doppio pendente

FINITURA	OLV	OGR	SAT	CR	CRS
IMBALLO	4	4	4	4	4



art. 3.2980

maniglia ad incasso
 50X40 mm

FINITURA	OLV	OGR	CR	CRS
IMBALLO	25	25	25	25



art. 3.2985

maniglia ad incasso
 ø 58 mm

FINITURA	OLV
IMBALLO	25



art. 3.2802

maniglia ad incasso ovale con sottoplastica
152x37 mm - int. 117x22 mm con foro chiave decentrato

art. 3.2803

maniglia ad incasso ovale con sottoplastica
152x37 mm - int. 117x22 mm senza foro chiave

FINITURA	OLV	OGR	CR	CRS
IMBALLO	12	12	12	12



art. 3.2812

maniglia ad incasso ovale con sottoplastica
125x40 mm - int. 80x24 mm con foro chiave centrale

art. 3.2813

maniglia ad incasso ovale con sottoplastica
125x40 mm - int. 80x24 mm senza foro chiave

FINITURA	OLV	OGR	CR	CRS
IMBALLO	12	12	12	12



art. 3.2900

maniglia ad incasso rettangolare
120x40 mm con foro chiave centrale

art. 3.2901

maniglia ad incasso rettangolare
120x40 mm senza foro chiave

FINITURA	OLV	OGR	CR	CRS
IMBALLO	12	12	12	12



art. 3.2912

maniglia ad incasso rettangolare con sottoplastica
125x40 mm - int. 80x24 mm con foro chiave centrale

art. 3.2913

maniglia ad incasso rettangolare con sottoplastica
125x40 mm - int. 80x24 mm senza foro chiave

FINITURA	OLV	OGR	CR	CRS
IMBALLO	12	12	12	12



art. 3.2950

maniglia per porte scorrevoli
158x37 mm da appoggio

FINITURA	OLV	OGR	CR	CRS
IMBALLO	12	12	12	12



art. 3.2960

maniglia ad incasso ovale Elisse
220x33 mm con foro chiave centrale

art. 3.2961

maniglia ad incasso ovale Elisse
220x33 mm senza foro chiave

FINITURA	OLV	OGR	CR	CRS
IMBALLO	12	12	12	12



art. 3.2970

maniglia ad incasso ovale
120X33 mm - int. 75x20 mm
con foro chiave decentrato

FINITURA	OLV	OGR	CR	CRS
IMBALLO	25	25	25	25



art. 3.2971

maniglia ad incasso ovale
120X33 mm - int. 75x20 mm
senza foro chiave

FINITURA	OLV	OGR	CR	CRS
IMBALLO	25	25	25	25



art. 3.2972

maniglia ad incasso ovale
120X33 mm - int. 75x20 mm con foro chiave centrale

FINITURA	OLV	OGR	CR	CRS
IMBALLO	25	25	25	25

SHS Serie KIT NICCHIE



art. 7.5100

kit nicchia tonda "wc"
compresa serratura e maniglia di trascinamento

FINITURA	OLV	ANT	CR	CRS
IMBALLO	1	1	1	1



art. 7.5110

kit nicchia tonda "foro chiave"
compresa serratura e maniglia di trascinamento

FINITURA	OLV	ANT	CR	CRS
IMBALLO	1	1	1	1



art. 7.5200

kit nicchia ovale coprivite con sottoplastica "wc"
compresa serratura e maniglietta di trascinamento

FINITURA	OLV	OGR	CR	CRS
IMBALLO	1	1	1	1



art. 7.5210

kit nicchia ovale coprivite con sottoplastica "foro chiave"
compresa serratura e maniglietta di trascinamento

FINITURA	OLV	OGR	CR	CRS
IMBALLO	1	1	1	1



art. 7.5400

kit nicchia rettangolare coprivite con sottoplastica "wc"
compresa serratura e maniglietta di trascinamento

FINITURA	OLV	OGR	CR	CRS
IMBALLO	1	1	1	1



art. 7.5410

kit nicchia rettangolare coprivite con sottoplastica "foro chiave"
compresa serratura e maniglietta di trascinamento

FINITURA	OLV	OGR	CR	CRS
IMBALLO	1	1	1	1



art. 7.5170

kit nicchia tonda con doppio pendente
compresa serratura e maniglietta di trascinamento

FINITURA	OLV	OGR	CR	CRS
IMBALLO	1	1	1	1



art. 7.5150

kit nicchia tonda con pendente e gettone
compresa serratura e maniglietta di trascinamento

FINITURA	OLV	OGR	CR	CRS
IMBALLO	1	1	1	1



art. 7.5300

kit nicchia quadra "wc"
compresa serratura e maniglia di trascinamento

FINITURA	OLV	OGR	CR	CRS
IMBALLO	1	1	1	1



art. 7.5310

kit nicchia quadra "foro chiave"
compresa serratura e maniglia di trascinamento

FINITURA	OLV	OGR	CR	CRS
IMBALLO	1	1	1	1



art. 7.5110.FE

kit nicchia tonda foro chiave compresa serratura
e maniglia di trascinamento

FINITURA	ORO	BR	CRS
IMBALLO	1	1	1



art. 7.5100.FE

kit nicchia tonda WC compresa serratura
e maniglia di trascinamento

FINITURA	ORO	BR	CRS
IMBALLO	1	1	1

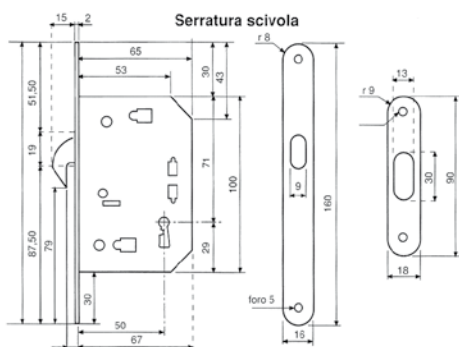
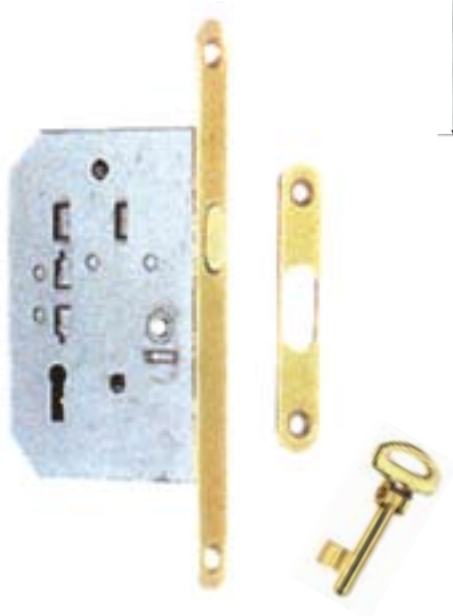

art. 7.5040

serratura per scorrevoli "foro chiave"

FINITURA	OLV	ANT	CR	CRS
IMBALLO	2	2	2	2

art. 7.5050

serratura per scorrevoli "wc"

FINITURA	OLV	ANT	CR	CRS
IMBALLO	2	2	2	2

art. 7.5060

piastra copriserratura per porte scorrevoli

FINITURA	OLV	BR	CR	CRS
IMBALLO	50	50	50	50



art. 3.2990

maniglia di trascinamento ditale
ø 25x20 mm

FINITURA	OLV	OGR	CR	CRS
IMBALLO	25	25	25	25



art. 3.2993

maniglia di trascinamento ditale quadrata
ø 25 - 27x27 mm

FINITURA	OLV	OGR	CR	CRS
IMBALLO	25	25	25	25

SET PER PORTE BLINDATE



art. CPB 2.1910

set per porte blindate composto da:
 A - pomolo Omega ø 60 mm
 C/D - acc. fissaggio
 B - rosetta ø 50 mm a pressione
 E - impugnatura Omega
 F - rosetta ø 50 mm a pressione
 G - ferro espansione 8x80 mm

FINITURA	ALL. BR	ALL. ARG	ALL. ORO
IMBALLO	1	1	1



art. CPB 1.6470

set per porte blindate composto da:
 A - pomolo Omega ø 60 mm
 C/D - acc. fissaggio
 B - rosetta ø 50 mm a pressione
 E - impugnatura Thea
 F - rosetta ø 50 mm a pressione
 G - ferro espansione 8x80 mm

FINITURA	ALL. BR	ALL. ARG	ALL. ORO
IMBALLO	1	1	1



art. CPB I.6468

set per porte blindate composto da:
 A - pomolo Omega ø 60 mm
 B - rosetta ø 50 mm a pressione
 C - impugnatura Thea
 D - ferro fisso
 nypless 8x100 mm

FINITURA	ALL. BR	ALL. ARG
IMBALLO	6	6



art. CPB I.956I

set per porte blindate composto da:
 A - pomolo Victoria ø 55 mm
 B - rosetta ø 45 mm a pressione
 C - impugnatura Karol
 D - ferro fisso
 nypless 8x100 mm

FINITURA	OLV	OGR	CRS
IMBALLO	1	1	1

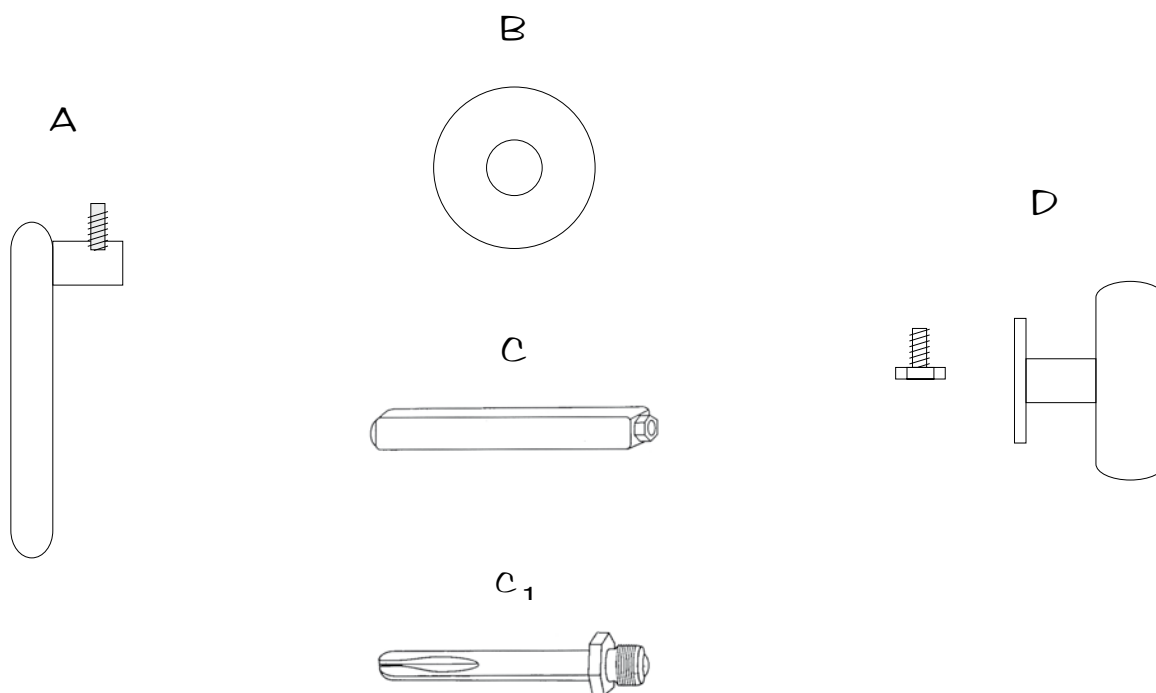

- A SERIE IMPUGNATURA MANIGLIA: A 1: VEGA - pag. 57
 A 2: KAROL - pag. 58
 A 3: GIOVE - pag. 32
 A 4: SEDNA - pag. 61

B ROSETTA \varnothing 50 mm A PRESSIONE UNIVERSALE

C FERRO ESPANZIONE 80 mm

C₁ FERRO NIPLES

- D SERIE POMOLO
 COMPLETO DI SOTTOROSONE: D 1: DENVER - pag. 141
 D 2: ATHOS - pag. 141
 D 3: LIA - pag. 140
 D 4: ARES - pag. 136



art. 2.9006

bocchetta
57x70 mm per chiave doppia mappa

FINITURA	OLV	OGR	CRS
IMBALLO	10	10	10



art. 2.9006.18

bocchetta
57x70 mm per foro yale

FINITURA	OLV	OGR	CRS
IMBALLO	10	10	10



art. 2.9007

bocchetta
57x70 mm per limitatore

FINITURA	OLV	OGR	CRS
IMBALLO	10	10	10



art. 2.9008.01

bocchetta
57x70 mm per chiave doppia mappa con copriforo

FINITURA	OLV	OGR	CRS
IMBALLO	10	10	10



art. 2.9008

coppia bocchetta
57x70 mm per chiave, doppia mappa con copriforo

FINITURA	OLV	OGR	CRS
IMBALLO	10	10	10



art. 2.9010

bocchetta coprivite con sottoplastica
 ø 45 mm per chiave, doppia mappa

FINITURA	OLV	OGR	SAT	CR	CRS
IMBALLO	30	30	30	30	30



art. 2.9012

coppia bocchetta coprivite con sottoplastica
 ø 45 mm per chiave, doppia mappa con copriforo

FINITURA	OLV	OGR	CRS
IMBALLO	10	10	10



art. 2.9020

bocchetta rettangolare
 50x36 mm per chiave, doppia mappa

FINITURA	OLV	OGR	SAT	CR	CRS
IMBALLO	10	10	10	10	10



art. 2.9022

coppia bocchetta rettangolare
 50x63 mm per chiave, doppia mappa con copriforo

FINITURA	OLV	OGR	CRS
IMBALLO	10	10	10



art. 2.9020.18

bocchetta rettangolare
 50x36 mm con foro cilindro

FINITURA	OLV	OGR	SAT	CR	CRS
IMBALLO	10	10	10	10	10



art. 2.9020.32

bocchetta rettangolare
 50x36 mm senza foro

FINITURA	OLV	OGR	SAT	CR	CRS
IMBALLO	10	10	10	10	10

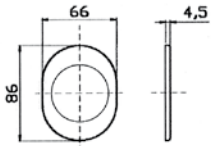

art. 5.4330

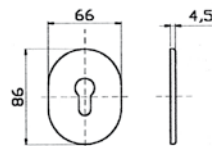

art. 5.4332

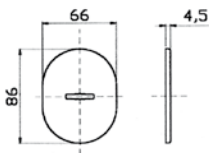

art. 5.4331

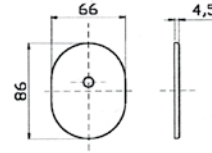

art. 5.4333

art. 5.4330

mostrina ovale coprivite per defender
66x86 mm con sottoplastica a pressione

art. 5.4331

mostrina ovale coprivite doppia mappa
66x86 mm con sottoplastica a pressione

art. 5.4332

mostrina ovale coprivite foro yale
66x86 mm con sottoplastica a pressione

art. 5.4333

mostrina ovale coprivite foro per pomello cilindro
66x86 mm con sottoplastica a pressione

FINITURA	OLV	OGR	CRS
IMBALLO	10	10	10

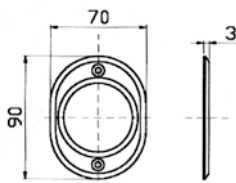

art. 5.4340

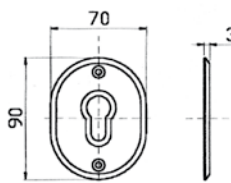

art. 5.4342

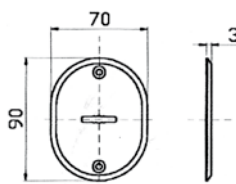

art. 5.4341

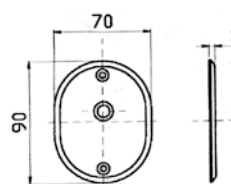

art. 5.4343

art. 5.4340

mostrina ovale coprivite per defender
70x90 mm - con viti in vista

art. 5.4341

mostrina ovale coprivite doppia mappa
70x90 mm - con viti in vista

art. 5.4342

mostrina ovale coprivite foro yale
70x90 mm - con viti in vista

art. 5.4343

mostrina ovale coprivite foro per pomello cilindro
70x90 mm - con viti in vista

FINITURA	OLV	OGR	CRS
IMBALLO	10	10	10

**art. 6.0150**nottolino sicurezza
con rosetta tonda e viti in vista

FINITURA	OLV	OGR	CRS
IMBALLO	20	20	20

**art. 6.0151**nottolino sicurezza
con rosetta ovale e viti in vista

FINITURA	OLV	OGR	CRS
IMBALLO	20	20	20

**art. 6.0153**nottolino sicurezza
con rosetta ovale a pressione

FINITURA	OLV	OGR	CRS	ALL. BR
IMBALLO	20	20	20	20

**art. 6.0156**nottolino sicurezza
con rosetta ø 50 mm a pressione

FINITURA	OLV	OGR	CRS	ALL. BR
IMBALLO	20	20	20	20

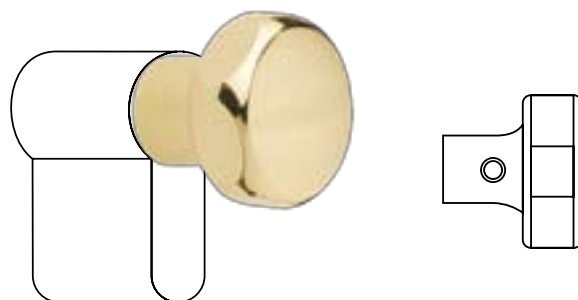
**art. 6.0157**

limitatore di apertura a scivolo

FINITURA	OLV	OGR	CRS	ALL. BR	ALL. ARG
IMBALLO	10	10	10	10	10

art. 6.0135pomello per cilindro
ø 30 mm - foro 8 mm

FINITURA	OLV	OGR	CRS
IMBALLO	10	10	10

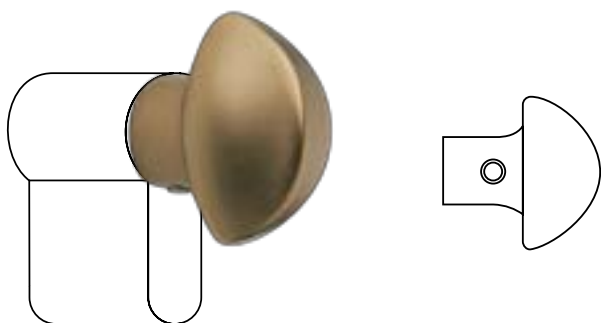
**art. 6.0149**pomello per cilindro
foro 8 mm

FINITURA	OLV	OGR	CRS	ALL. BR
IMBALLO	10	10	10	10

**art. 6.0130**pomello per cilindro
ø 38 mm - foro 8 mm

FINITURA	OLV	OGR	CRS
IMBALLO	10	10	10

serie POMOLI ACCOPPIATI



art. I.1092

coppia pomolo Victorian
con rosetta e bocchetta con viti in vista senza molla

FINITURA	OLV	OGR	CRS
IMBALLO	1	1	1

art. I.1095

coppia pomolo Victorian
con rosetta e bocchetta Lux ø 45 mm ad avvitare

FINITURA	OLV	OGR	CRS
IMBALLO	1	1	1



art. PO.2.2576

coppia pomolo Lotus 50x50 mm
con rosetta e bocchetta quadra 45x45 mm a pressione

FINITURA	OLV	OGR	CRS
IMBALLO	1	1	1



art. I.9096

coppia pomolo Diamante ø 60 mm
con rosetta senza bocchetta

FINITURA	OLV	OGR
IMBALLO	1	1



art. I.4660

coppia pomolo Urano decentrato
con rosetta e bocchetta ø 50 mm ad avvitare

FINITURA	OLV
IMBALLO	1

art. I.4663

coppia pomolo Urano decentrato
con rosetta e bocchetta ovale

FINITURA	OLV
IMBALLO	1

**art. I.9116**

coppia pomolo Sfera ø 60 mm
con rosetta senza bocchetta

FINITURA	OLV
IMBALLO	1

**art. I.9200**

coppia pomolo Urano ø 60 mm
con rosetta senza bocchetta

FINITURA	OLV
IMBALLO	1

**art. I.9210**

coppia pomolo Nettuno ø 60 mm
con rosetta senza bocchetta

FINITURA	OLV
IMBALLO	1

**art. I.5395**

coppia pomolo Asia con rosetta
e bocchetta Lux 45 mm ad avvitare

FINITURA	OLV	ANT
IMBALLO	1	1

**art. I.6585**

coppia pomolo Giulia con rosetta
e bocchetta Lux 45 mm ad avvitare in porcellana bianca

FINITURA	PBN/OLV	PBN/ANT
IMBALLO	1	1

**art. I.3072**

coppia pomolo tondo Alba con rosetta e bocchetta
con viti in vista senza molla in porcellana bianca decorata

art. I.3082

coppia pomolo ovale Alba con rosetta e bocchetta
con viti in vista senza molla in porcellana bianca decorata

FINITURA	PBND/OLV	PBND/ANT
IMBALLO	1	1

**art. I.3075**

coppia pomolo tondo Alba con rosetta
e bocchetta Lux ad avvitare in porcellana bianca decorata

art. I.3085

coppia pomolo ovale Alba con rosetta
e bocchetta Lux ad avvitare in porcellana bianca decorata

FINITURA	PBND/OLV	PBND/ANT
IMBALLO	1	1

**art. I.3972**

coppia pomolo tondo con rosetta e bocchetta
con viti in vista senza molla in porcellana bianca

art. I.3982

coppia pomolo ovale con rosetta e bocchetta
con viti in vista senza molla in porcellana bianca

FINITURA	PBN/OLV	PBN/ANT
IMBALLO	1	1

**art. I.3975**

coppia pomolo tondo con rosetta
e bocchetta Lux ad avvitare in porcellana bianca

art. I.3985

coppia pomolo ovale con rosetta
e bocchetta Lux ad avvitare in porcellana bianca

FINITURA	PBN/OLV	PBN/ANT
IMBALLO	1	1

**art. I.5572**

coppia pomolo tondo con rosetta e bocchetta
con viti in vista senza molla in porcellana bianca c/fiore blu

art. I.5582

coppia pomolo ovale con rosetta e bocchetta
con viti in vista senza molla in porcellana bianca c/fiore blu

FINITURA	PBN F. BLU/OLV	PBN F. BLU/ANT
IMBALLO	1	1

**art. I.5575**

coppia pomolo tondo con rosetta
e bocchetta Lux ad avvitare in porcellana bianca c/fiore blu

art. I.5585

coppia pomolo ovale con rosetta
e bocchetta Lux ad avvitare in porcellana bianca c/fiore blu

FINITURA	PBN F. BLU/OLV	PBN F. BLU/ANT
IMBALLO	1	1

**art. I.6072**

coppia pomolo tondo Gemma con rosetta e bocchetta
con viti in vista senza molla in porcellana champagne decorata

art. I.6082

coppia pomolo ovale Gemma con rosetta e bocchetta
con viti in vista senza molla in porcellana champagne decorata

FINITURA	PCHD/OLV	PCHD/ANT
IMBALLO	1	1

**art. I.6075**

coppia pomolo tondo Gemma con rosetta
e bocchetta Lux ad avvitare in porcellana champagne decorata

art. I.6085

coppia pomolo ovale Gemma con rosetta
e bocchetta Lux ad avvitare in porcellana champagne decorata

FINITURA	PCHD/OLV	PCHD/ANT
IMBALLO	1	1

**art. I.6172**

coppia pomolo tondo con rosetta e bocchetta
con viti in vista senza molla in porcellana champagne

art. I.6182

coppia pomolo ovale con rosetta e bocchetta
con viti in vista senza molla in porcellana champagne

FINITURA	PCH/OLV	PCH/ANT
IMBALLO	1	1

**art. I.6175**

coppia pomolo tondo con rosetta
e bocchetta Lux ad avvitare in porcellana champagne

art. I.6185

coppia pomolo ovale con rosetta
e bocchetta Lux ad avvitare in porcellana champagne

FINITURA	PCH/OLV	PCH/ANT
IMBALLO	1	1

**art. I.6272**

coppia pomolo tondo Anna con rosetta e bocchetta
con viti in vista senza molla in porcellana bianca decorata

art. I.6282

coppia pomolo ovale Anna con rosetta e bocchetta
con viti in vista senza molla in porcellana bianca decorata

FINITURA	PBND/OLV	PBND/ANT
IMBALLO	1	1

**art. I.6275**

coppia pomolo tondo Anna con rosetta
e bocchetta Lux ad avvitare in porcellana bianca decorata

art. I.6285

coppia pomolo ovale Anna con rosetta
e bocchetta Lux ad avvitare in porcellana bianca decorata

FINITURA	PBND/OLV	PBND/ANT
IMBALLO	1	1

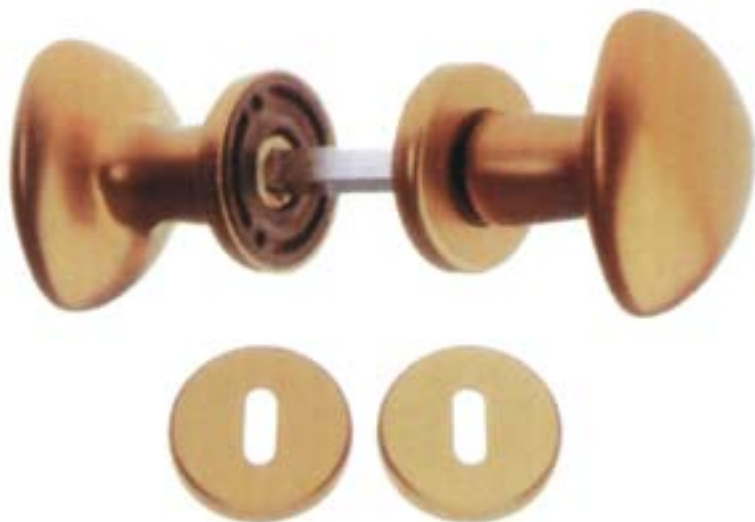

art. 1.9130

guarnitura Triangolo **alluminio**
rosetta e bocchetta ø 50 mm a pressione

FINITURA	ALL. BR	ALL. ARG
IMBALLO	4	4



art. 1.9140

guarnitura Uovo **alluminio**
rosetta e bocchetta ø 50 mm a pressione

FINITURA	ALL. BR	ALL. ARG
IMBALLO	4	4



art. 1.9130

guarnitura Triangolo **ottone**
rosetta e bocchetta ø 45 mm a pressione

FINITURA	OLV	SAT	CRS
IMBALLO	2	2	2

serie POMOLI FISSI



art. 3.2030

pomolo Ares ø 65 mm
base 56 mm con sottorosone e esagono

FINITURA	OLV	OGR	CRS	PVD
IMBALLO	2	2	2	2



art. 3.2090

pomolo Zeus ø 74 mm
base 56 mm con sottorosone e esagono

FINITURA	OLV	OGR	CRS	PVD
IMBALLO	2	2	2	2



art. 3.2170.07

pomolo Elite
ø 70 mm con perno passante

FINITURA	OLV	OGR	CRS
IMBALLO	10	10	10

art. 3.2170.17

pomolo Elite
ø 70 mm con sottorosone

FINITURA	OLV	OGR	CRS
IMBALLO	10	10	10



art. 3.0006.07

pomolo Georgian
ø 70 mm con perno passante

FINITURA	OLV	OGR
IMBALLO	6	6



art. 3.0033

pomolo Ringo
ø 60 mm con perno passante

FINITURA	OLV	OGR
IMBALLO	15	15



art. 3.0096.06

pomolo Diamante
ø 60 mm con perno passante

FINITURA	OLV	OGR
IMBALLO	8	8

art. 3.0096.07

pomolo Diamante
ø 70 mm con perno passante

FINITURA	OLV	OGR
IMBALLO	6	6

art. 3.0096.08

pomolo Diamante
ø 80 mm con perno passante

FINITURA	OLV	OGR
IMBALLO	2	2



art. 3.0106.07

pomolo Victorian
 ø 70 mm con perno passante

FINITURA	OLV	OGR
IMBALLO	2	2



art. 3.0109

pomolo Classic
 ø 70 mm con perno passante

FINITURA	OLV	OGR	CRS
IMBALLO	6	6	6

art. 3.0109.17

pomolo Classic
 ø 70 mm con sottorosone

FINITURA	OLV	OGR	CRS
IMBALLO	6	6	6



art. 3.0110

pomolo ottagonale
 ø 70 mm con perno passante

FINITURA	FUMÈ
IMBALLO	6



art. 3.0116.06

pomolo sfera
ø 80 mm con perno passante

FINITURA	OLV	OGR	CRS
IMBALLO	8	8	8

art. 3.0116.07

pomolo sfera
ø 70 mm con perno passante

FINITURA	OLV	OGR	CRS
IMBALLO	6	6	6

art. 3.0116.08

pomolo sfera
ø 80 mm con perno passante

FINITURA	OLV	OGR	CRS
IMBALLO	2	2	2



art. 3.2000

pomolo Gemini ø 43 mm
con rosetta - ferro espansione 55 mm

FINITURA	OLV	SAT	CRS
IMBALLO	6	6	6



art. 3.2001

pomolo Gemini ø 64 mm
con rosetta ø 50 mm a pressione e sottorosso

FINITURA	OLV	SAT	CRS
IMBALLO	10	10	10



art. 3.2010

pomolo Drop
ø 70 mm con perno passante

FINITURA	OLV
IMBALLO	6



art. 3.2020.17

pomolo Lutus quadrato 50x50 mm
con rosetta 45x45 mm con sottorosone

FINITURA	OLV	OGR	CR	CRS
IMBALLO	4	4	4	4



art. 3.2070

pomolo Lia
ø 63 mm con rosetta 50 mm e sottorosone

FINITURA	OLV	OGR	CRS
IMBALLO	6	6	6



art. 3.2040.07

pomolo Athos
 ø 63 mm - rosetta ø 69 mm con perno passante

FINITURA	OLV	OGR OP	SAT	CRS
IMBALLO	10	10	10	10



art. 3.2040.17

pomolo Athos
 ø 63 mm - rosetta ø 69 mm con sottorosone

FINITURA	OLV	OGR OP	SAT	CRS
IMBALLO	10	10	10	10



art. 3.2045.17

pomolo Denver
 ø 63 mm - rosetta ø 50 mm con sottorosone

FINITURA	OLV	OGR	CRS
IMBALLO	10	10	10



art. 3.1060.16

pomolo Kubik quadro 60x60 mm
 con rosetta 50x50 mm con sottorosone

FINITURA	INOX
IMBALLO	2

art. 3.1060.17

pomolo Kubik quadro 70x70 mm
 con rosetta 50x50 mm con sottorosone

FINITURA	INOX
IMBALLO	2



art. 3.2055

pomolo Cris
ø 78 mm con perno passante

FINITURA	OLV	ANT
IMBALLO	6	6



art. 3.2060

pomolo Zara ø 65 mm
base ø 56 mm con sottorosone e esagono

FINITURA	OLV	OGR	CRS
IMBALLO	2	2	2



art. 3.2080

pomolo Dora ø 65 mm
base ø 56 mm con sottorosone e esagono

FINITURA	OLV	OGR	CRS
IMBALLO	2	2	2



art. 3.2110

pomolo ottagonale
ø 62 mm

FINITURA	FERRO NR
IMBALLO	2



art. 3.2120

pomolo Denz
ø 65 mm

FINITURA	FERRO NR
IMBALLO	2



art. 3.2130

pomolo Spagna ø 72 mm
base ø 84 mm con perno passante

FINITURA	OLV	CR
IMBALLO	2	2



art. 3.2140

pomolo Giglio
ø 70 mm con perno passante

FINITURA	BR
IMBALLO	12



art. 3.2150

pomolo Luna
ø 70 mm con perno passante

FINITURA	BR
IMBALLO	12



art. 3.2160

pomolo Sole
ø 70 mm con perno passante

FINITURA	BR
IMBALLO	12



art. 3.2180.07

pomolo Blindo
ø 70 mm con perno passante

FINITURA	OLV	OGR
IMBALLO	10	10

art. 3.2180.17

pomolo Blindo
ø 70 mm con sottorosone

FINITURA	OLV	OGR
IMBALLO	10	10



art. 3.2190

pomolo concavo
ø 70 mm con perno passante

FINITURA	OLV	OGR
IMBALLO	12	12



art. 3.2200.06

pomolo Urano
ø 60 mm con perno passante

FINITURA	OLV
IMBALLO	8

art. 3.2200.07

pomolo Urano
ø 70 mm con perno passante

FINITURA	OLV
IMBALLO	6



art. 3.2210.06

pomolo Nettuno
ø 60 mm con perno passante

FINITURA	OLV
IMBALLO	8

art. 3.2210.07

pomolo Nettuno
ø 70 mm con perno passante

FINITURA	OLV
IMBALLO	6



art. 3.2230.06

pomolo Plutone
ø 60 mm con perno passante

FINITURA	OLV
IMBALLO	8

art. 3.2230.07

pomolo Plutone
ø 70 mm con perno passante

FINITURA	OLV
IMBALLO	6



art. 3.2240.06

pomolo Mercurio
ø 60 mm con perno passante

FINITURA	OLV
IMBALLO	8

art. 3.2240.07

pomolo Mercurio
ø 70 mm con perno passante

FINITURA	OLV
IMBALLO	6



art. 3.2250.06

pomolo Margherita ø 60 mm
base ø 80 mm con perno passante

FINITURA	OLV	OGR
IMBALLO	6	6

art. 3.2250.07

pomolo Margherita ø 70 mm
base ø 80 mm con perno passante

FINITURA	OLV	OGR
IMBALLO	6	6

art. 3.2250.08

pomolo Margherita ø 80 mm
base ø 100 mm con perno passante

FINITURA	OLV	OGR
IMBALLO	4	4



art. 3.2260

pomolo Ottagonale
ø 85 mm con perno passante o sottorosone

FINITURA	OLV	ANT
IMBALLO	2	2



art. 3.2270

pomolo Onda
ø 95 mm con perno passante o sottorosone

FINITURA	OLV
IMBALLO	2



art. 3.2280

pomolo Base sagomata \varnothing 70 mm
base \varnothing 77 mm con perno passante

FINITURA	OLV	OGR
IMBALLO	8	8



art. 3.2290

pomolo Leo con rosetta \varnothing 50 mm ad avvitare
con ferro nyplés

FINITURA	OLV	OGR	CRS
IMBALLO	2	2	2



art. 3.2420

pomolo Madrid \varnothing 70 mm
base \varnothing 80 mm con perno passante

FINITURA	OLV	OGR
IMBALLO	6	6



art. 3.6400

pomolo Thea **alluminio**
ø 70 mm fisso con sottorosone

FINITURA	ALL. BR	ALL. ARG
IMBALLO	10	10



art. 3.6450

pomolo Omega **alluminio**
ø 60 mm fisso con sottorosone

FINITURA	ALL. BR	ALL. ARG
IMBALLO	10	10



art. 3.6500

pomolo Triangolo **alluminio**
fisso con sottorosone - rosetta ø 50 mm a pressione

FINITURA	ALL. BR	ALL. ARG
IMBALLO	10	10



art. 3.6500

pomolo Triangolo **ottone**
fisso con sottorosone - rosetta ø 50 mm a pressione

FINITURA	OLV	SAT	CRS
IMBALLO	4	4	4



art. 7.4620.37

pomolo caposcala h. 69 mm

MISURA	ø 37 fil 10 MA
FINITURA	OLV
IMBALLO	6



art. 7.4620.48

pomolo caposcala h. 88 mm

MISURA	ø 48 fil 10 MA
FINITURA	OLV
IMBALLO	4



art. 7.4620.55

pomolo caposcala h. 103 mm

MISURA	ø 55 fil 10 MA
FINITURA	OLV
IMBALLO	4



art. 7.4670

pomolo caposcala liscio

MISURA	ø 25 fil 8 MA	ø 30 fil 8 MA	ø 40 fil 10 MA
FINITURA	OL	OL	OL
IMBALLO	30	30	24

MISURA	ø 50 fil 10 MA	ø 60 fil 12 MA	ø 70 fil 14 MA
FINITURA	OL	OL	OL
IMBALLO	6	5	5



art. 7.4680

pomolo caposcala con fascia

MISURA	ø 20 fil 8 MA	ø 25 fil 8 MA	ø 30 fil 10 MA	ø 35 fil 10 MA
FINITURA	TORNITO	TORNITO	TORNITO	TORNITO
IMBALLO	50	30	30	24

MISURA	ø 40 fil 10 MA	ø 45 fil 10 MA	ø 50 fil 10 MA	ø 60 fil 12 MA	ø 70 fil 14 MA
FINITURA	TORNITO	TORNITO	TORNITO	TORNITO	TORNITO
IMBALLO	30	24	6	5	5

Series POMOLINI VETRO MURANO



art. 3.8200

pomolino liscio in vetro scavo di murano ø 27 mm

FINITURA	BIANCO/ORO	ROSA/ORO	BLU/ORO
IMBALLO	12	12	12

FINITURA	VERDE/ORO	AMBRA/ORO
IMBALLO	12	12

art. 3.8250

pomolino rigato in vetro scavo di murano ø 27 mm

FINITURA	BIANCO/ORO	ROSA/ORO	BLU/ORO
IMBALLO	12	12	12

FINITURA	VERDE/ORO	AMBRA/ORO
IMBALLO	12	12

Series POMOLINI VERSILIA



art. 3.8300

pomolino a funghetto in marmo ø 25 mm

FINITURA	BIANCO	ROSA	VERDE
IMBALLO	24	24	24

FINITURA	ROSSO	NERO	TRAVERTINO
IMBALLO	24	24	24

art. 3.8350

pomolino a sfera in marmo ø 25 mm

FINITURA	BIANCO	ROSA	VERDE
IMBALLO	24	24	24

FINITURA	ROSSO	NERO	TRAVERTINO
IMBALLO	24	24	24

Serie POMOLINI PORCELLANA



art. 3.8000

pomolino tondo senza base

MISURA	ø 26 - h. 24 mm	ø 30 - h. 25 mm
FINITURA	PBN	PBN
IMBALLO	50	50



art. 3.8001

pomolino tondo senza base

MISURA	ø 30 - h. 25 mm	
FINITURA	PAZZURRO	
IMBALLO	50	



art. 3.8002

pomolino tondo senza base

MISURA	ø 30 - h. 25 mm	
FINITURA	PVERDE	
IMBALLO	50	



art. 3.8003

pomolino tondo senza base

MISURA	ø 26 - h. 24 mm	ø 30 - h. 25 mm
FINITURA	PCH	PCH
IMBALLO	50	50



art. 3.8006

pomolino tondo senza base

MISURA	ø 26 - h. 24 mm	ø 30 - h. 25 mm
FINITURA	PBN F. MARRONE	PBN F. MARRONE
IMBALLO	50	50



art. 3.8007

pomolino tondo senza base

MISURA	ø 26 - h. 24 mm	ø 30 - h. 25 mm
FINITURA	PCH IBISCO	PCH IBISCO
IMBALLO	50	50



art. 3.8008

pomolino tondo senza base

MISURA	ø 26 - h. 24 mm	ø 30 - h. 25 mm
FINITURA	PBN IBISCO	PBN IBISCO
IMBALLO	50	50



art. 3.8010

pomolino tondo senza base

MISURA	ø 26 - h. 24 mm	ø 30 - h. 25 mm
FINITURA	PBN C/FIORE	PBN C/FIORE
IMBALLO	50	50

**art. 3.8011**

pomolino tondo senza base

MISURA	ø 30 - h. 25 mm
FINITURA	PBN F. BLU
IMBALLO	50

**art. 3.8013**

pomolino tondo senza base

MISURA	ø 30 - h. 25 mm
FINITURA	PCH C/FIORE
IMBALLO	50

**art. 3.8015**

pomolino tondo senza base

MISURA	ø 30 - h. 25 mm
FINITURA	PBN F. ROSA
IMBALLO	50

**art. 3.8020**

pomolino tondo senza base

MISURA	ø 30 - h. 25 mm
FINITURA	PBN RIGA ORO
IMBALLO	50

**art. 3.8023**

pomolino tondo senza base

MISURA	ø 30 - h. 25 mm
FINITURA	PCH F. CAMPO
IMBALLO	50

**art. 3.8025**

pomolino tondo senza base

MISURA	ø 30 - h. 25 mm
FINITURA	PNR
IMBALLO	50

**art. 3.8030**

pomolino ovale senza base

MISURA	33x24 - h. 26 mm
FINITURA	PBN
IMBALLO	50

**art. 3.8031**

pomolino ovale senza base

MISURA	33x24 - h. 26 mm
FINITURA	PAZZURRO
IMBALLO	50

**art. 3.8032**

pomolino ovale senza base

MISURA	33x24 - h. 26 mm
FINITURA	PVERDE
IMBALLO	50

**art. 3.8033**

pomolino ovale senza base

MISURA	33x24 - h. 26 mm
FINITURA	PCH
IMBALLO	50



art. 3.8040

pomolino ovale senza base

MISURA	33x24 - h. 26 mm
FINITURA	PBN C/FIORE
IMBALLO	50



art. 3.8041

pomolino ovale senza base

MISURA	33x24 - h. 26 mm
FINITURA	PBN F. BLU
IMBALLO	50



art. 3.8043

pomolino ovale senza base

MISURA	33X24 - h. 26 mm
FINITURA	PCH C/FIORE
IMBALLO	50



art. 3.8044

pomolino ovale senza base

MISURA	33X24 - h. 26 mm
FINITURA	PBN IBISCO
IMBALLO	50



art. 3.8046

pomolino ovale senza base

MISURA	33X24 - h. 26 mm
FINITURA	PBN MIOSOTIS
IMBALLO	50



art. 3.8047

pomolino ovale senza base

MISURA	33X24 - h. 26 mm
FINITURA	PBN DEC. BLU
IMBALLO	50



art. 3.8048

pomolino ovale senza base

MISURA	33x24 - h. 26 mm
FINITURA	PCH IBISCO
IMBALLO	50



art. 3.8049

pomolino ovale senza base

MISURA	33x24 - h. 26 mm
FINITURA	PBN F. MARRONE
IMBALLO	50

**art. 3.8050**

pomolino rettangolare BN senza base

MISURA	25X30 - h. 18 mm
FINITURA	PBN C/RIGA
IMBALLO	25

**art. 3.8060**

pomolino goccia senza base

MISURA	ø 26 - h. 36 mm
FINITURA	PBN
IMBALLO	25

**art. 3.8065**

pomolino ovale senza base

MISURA	ø 26 - h. 36 mm
FINITURA	PBN C/FIORE
IMBALLO	25

**art. 3.8068**

pomolino ovale senza base

MISURA	ø 26 - h. 36 mm
FINITURA	PBN F. BLU
IMBALLO	25

**art. 3.8069**

pomolino goccia senza base

MISURA	ø 26 - h. 36 mm
FINITURA	PCH C/FIORE
IMBALLO	25

**art. 3.8070**

pomolino tondo senza base

MISURA	ø 30 - h. 25 mm
FINITURA	PBN FRUTTA
IMBALLO	50

**art. 3.8071**

pomolino tondo senza base

MISURA	ø 30 - h. 25 mm
FINITURA	PBN LIMONE
IMBALLO	50

**art. 3.8072**

pomolino tondo senza base

MISURA	ø 30 - h. 25 mm
FINITURA	PBN PERE
IMBALLO	50

**art. 3.8073**

pomolino tondo senza base

MISURA	ø 30 - h. 25 mm
FINITURA	PBN MELA
IMBALLO	50

**art. 3.8074**

pomolino tondo senza base

MISURA	ø 30 - h. 25 mm
FINITURA	PBN UVA
IMBALLO	50

**art. 3.8075**

pomolino tondo senza base

MISURA	ø 30 - h. 25 mm
FINITURA	PBN BOSCO
IMBALLO	50

**art. 3.8076**

pomolino tondo senza base

MISURA	ø 30 - h. 25 mm
FINITURA	PBN MISTO
IMBALLO	50

**art. 3.8078**

pomolino tondo senza base

MISURA	ø 30 - h. 25 mm
FINITURA	PBN MELA VERDE
IMBALLO	50

**art. 3.8083**

pomolino tondo senza base

MISURA	ø 26 - h. 24 mm	ø 30 - h. 25 mm
FINITURA	PCH CRACKLÈ	PCH CRACKLÈ
IMBALLO	50	50

**art. 3.8080**

pomolino tondo senza base

MISURA	ø 38 - h. 27 mm
FINITURA	PBN
IMBALLO	50

**art. 3.8081**

pomolino tondo senza base

MISURA	ø 38 - h. 27 mm
FINITURA	PCH
IMBALLO	50

**art. 3.8082**

pomolino tondo senza base

MISURA	ø 38 - h. 27 mm
FINITURA	PCH CRACKLÈ
IMBALLO	50

**art. 3.8090**

pomolino ovale senza base

MISURA	48x27 - h. 27 mm
FINITURA	PBN
IMBALLO	50

**art. 3.8091**

pomolino ovale senza base

MISURA	48x27 - h. 27 mm
FINITURA	PCH
IMBALLO	50

**art. 3.8092**

pomolino ovale senza base

MISURA	48x27 - h. 27 mm
FINITURA	PCH CRACKLÈ
IMBALLO	50

**art. 3.8120.28**pomolino zucca
ø 28 - h. 27 mm

FINITURA	PBN/OLV
IMBALLO	50

**art. 3.8120.33**pomolino zucca
ø 33 - h. 32 mm

FINITURA	PBN/OLV
IMBALLO	50

**art. 2.9100**

bocchetta ø 31 mm

	2.9100	2.9110	2.9120
FINITURA	PBN	PBN C/FIORE	PCH
IMBALLO	25	25	25

**art. 2.9900**base ø 18 mm
per pomolini in porcellana

FINITURA	OL	NIK	ANT
IMBALLO	50	50	50

PROMOZIONALE FINO AD ESAURIMENTO SCORTE



art. 3.8130

pomolino Splendid

	3.8130.25	3.8130.30
MISURA	ø 25 - h. 27 mm	ø 30 - h. 32 mm
FINITURA	PBN/ORO	PBN/ORO
IMBALLO	50	50



BIANCO
art. 3.8170



DECORATO
art. 3.8171



CHAMPAGNE
art. 3.8173



NERO
art. 3.8177

art. 3.8170

pomolino mignon con base OL

MISURA	ø 18 - h. 24 mm
FINITURA	BN
IMBALLO	50



BIANCO
art. 3.8180



BLU
art. 3.8181



VERDE
art. 3.8182



CHAMPAGNE
art. 3.8183



GIALLO
art. 3.8184

art. 3.8180

pomolino tondo con base OL

MISURA	ø 25 - h. 32 mm
FINITURA	BN
IMBALLO	25



art. 3.8900

pomolino tondo senza base

MISURA	ø 25 - h. 25 mm	ø 25 - h. 20 mm
FINITURA	PBN/OL	PBN/ANT
IMBALLO	50	50



art. 3.8910

pomolino tondo senza base

MISURA	ø 25 - h. 25 mm	ø 25 - h. 20 mm
FINITURA	P MARRONE/OL	P MARRONE/ANT
IMBALLO	50	50



art. 3.8920

pomolino tondo senza base

MISURA	ø 25 - h. 25 mm	ø 25 - h. 20 mm
FINITURA	PCH/OL	PCH/ANT
IMBALLO	50	50



art. 3.9010

pomolino tondo senza base
ø 36 - h. 23 mm

FINITURA	PBN
IMBALLO	50



art. 3.9020

pomolino tondo senza base
ø 36 - h. 23 mm

FINITURA	PBN
IMBALLO	50



art. 3.8197

maniglia ad anello
ø 32 mm

FINITURA	OLV	BR	CR
IMBALLO	25	25	25



art. 3.8380

pomolino Basket

MISURA	ø 30 - h. 55 mm
FINITURA	FERRO NR
IMBALLO	30



art. 3.8540

pomolino scalinato

MISURA	ø 30 - h. 25 mm
FINITURA	OLV
IMBALLO	25



art. 3.8560

pomolino margherita

MISURA	ø 30 - h. 29 mm
FINITURA	OLV
IMBALLO	25



art. 3.8580

pomolino ottone goccia

MISURA	ø 14 - h. 22 mm
FINITURA	OLV
IMBALLO	30



art. 3.8600

pomolino Zeta

	8.600.25	8.600.30	8.600.35
MISURA	ø 25 - h. 22 mm	ø 30 - h. 26 mm	ø 35 - h. 30 mm
FINITURA	Z. OTT	Z. OTT	Z. OTT
IMBALLO	50	50	50
FINITURA	Z. BR	Z. BR	Z. BR



art. 3.8700

pomolino

MISURA	ø 18 mm	ø 22 mm	ø 26 mm	ø 30 mm
FINITURA	OLV	OLV	OLV	OLV
IMBALLO	50	50	30	30



art. 3.8705

pomolino

MISURA	ø 22 mm	ø 28 mm	ø 34 mm	ø 40 mm
FINITURA	OLV	OLV	OLV	OLV
IMBALLO	50	50	30	30



art. 3.8710

pomolino

MISURA	ø 15 mm	ø 20 mm	ø 25 mm	ø 30 mm	ø 35 mm
FINITURA	OLV	OLV	OLV	OLV	OLV
IMBALLO	50	50	30	30	20
FINITURA	CRS	CRS	CRS	CRS	CRS



art. 3.8715

pomolino

MISURA	ø 20 mm	ø 25 mm	ø 30 mm	ø 32 mm
FINITURA	OLV	OLV	OLV	OLV
IMBALLO	50	30	30	30
FINITURA	CRS	CRS	CRS	CRS



art. 3.8720

pomolino

MISURA	ø 17 mm	ø 20 mm	ø 25 mm	ø 32 mm
FINITURA	OLV	OLV	OLV	OLV
IMBALLO	50	50	50	30



art. 3.8725

pomolino

MISURA	ø 17 mm	ø 21 mm	ø 26 mm	ø 32 mm
FINITURA	OLV	OLV	OLV	OLV
IMBALLO	50	50	50	30

**art. 3.8730**

pomolino

MISURA	ø 20 mm	ø 25 mm	ø 30 mm	ø 35 mm
FINITURA	OLV	OLV	OLV	OLV
IMBALLO	50	30	30	30

**art. 3.8733**

pomolino

MISURA	ø 25 mm	ø 30 mm	ø 35 mm
FINITURA	OLV	OLV	OLV
IMBALLO	30	30	30

**art. 3.8740**

pomolino

MISURA	ø 14 mm	ø 18 mm	ø 22 mm
FINITURA	OLV	OLV	OLV
IMBALLO	50	50	50

**art. 3.8745**

pomolino

MISURA	ø 12 mm	ø 12 mm
FINITURA	OLV	CRS
IMBALLO	50	50

**art. 3.8750**

pomolino

MISURA	ø 15 mm	ø 15 mm
FINITURA	OLV	CRS
IMBALLO	50	50

**art. 3.8755**

pomolino

MISURA	ø 17 mm
FINITURA	OLV
IMBALLO	50

**art. 3.8760**

pomolino

MISURA	ø 24 mm	ø 24 mm
FINITURA	OLV	CRS
IMBALLO	50	50

**art. 3.8765**

pomolino

MISURA	ø 20 mm	ø 25 mm	ø 30 mm
FINITURA	OLV	OLV	OLV
IMBALLO	50	50	30

**art. 3.8770**

pomolino

MISURA	ø 25 mm	ø 32 mm	ø 38 mm
FINITURA	OLV	OLV	OLV
IMBALLO	25	25	25

**art. 3.8775**

pomolino ovale in due pezzi

MISURA	ø 18 mm	ø 25 mm	ø 30 mm
FINITURA	OLV	OLV	OLV
IMBALLO	50	30	30

**art. 3.8778**

pomolino

MISURA	ø 16 mm	ø 20 mm	ø 25 mm	ø 30 mm
FINITURA	OLV	OLV	OLV	OLV
IMBALLO	50	50	50	30

**art. 3.8780**

pomolino

MISURA	ø 25 mm	ø 30 mm
FINITURA	OLV	OLV
IMBALLO	50	50

**art. 3.8810**

pomolino rigato

MISURA	ø 16 mm	ø 16 mm
FINITURA	Z. OTT	Z. CR
IMBALLO	50	50

art. 3.8820

pomolino corona

MISURA	ø 30 mm
FINITURA	Z. OTT
IMBALLO	50

**art. 3.8830**

pomolino 800

MISURA	ø 25 mm	ø 30 mm
FINITURA	Z. ANT	Z. ANT
IMBALLO	50	50

FINITURA	Z. ORO ANT	Z. ORO ANT
----------	------------	------------

FINITURA	Z. ARG ANT	Z. ARG ANT
----------	------------	------------

**art. 3.8850**

pomolino Fiore

MISURA	30x15x29 mm	25x12x24 mm
FINITURA	ANT	ANT
IMBALLO	25	25

**art. 3.8870**

pomolino quadro

MISURA	30x18x24 mm	25x16x20 mm
FINITURA	ANT	ANT
IMBALLO	25	25

art. 3.9000

pomolino

MISURA	ø 30 mm	ø 30 mm
FINITURA	PBN/ANT	PBN/CRS
IMBALLO	25	25

art. 3.9130

pomolino

MISURA	ø 26 mm	ø 30 mm
FINITURA	OLV	OLV
IMBALLO	50	50

MISURA	ø 26 mm	ø 30 mm
FINITURA	CR	CR

serie PENDENTI PORCELLANA



art. 3.8190

pendente snodato
60x23 mm

FINITURA	PBN
IMBALLO	25



art. 3.8191

pendente snodato anticato
60x23 mm

FINITURA	PCH IBISCO
IMBALLO	25



art. 3.8192

pendente snodato anticato
60x23 mm

FINITURA	PBN F. BLU
IMBALLO	25



art. 3.8193

pendente snodato
60x23 mm

FINITURA	PCH
IMBALLO	25



art. 3.8194

pendente snodato
60x23 mm

FINITURA	OLV	ANT
IMBALLO	25	25



art. 3.8195

pendente snodato
60x23 mm

FINITURA	PBN C/FIORE
IMBALLO	25



art. 3.8196

pendente snodato anticato
60x23 mm

FINITURA	PBN F. MARRONE
IMBALLO	25



art. 3.8199

pendente snodato anticato
60x23 mm

FINITURA	PCH C/FIORE
IMBALLO	25



art. 3.2600

maniglia Extra

MISURA	imp. 74 mm
FINITURA	PBN/ANT
IMBALLO	25



art. 3.2600

maniglia Extra

MISURA	imp. 74 mm
FINITURA	PBN/GRS
IMBALLO	25



art. 3.2601

maniglia Extra anticata

MISURA	imp. 74 mm
FINITURA	PBN MELA VERDE
IMBALLO	25



art. 3.2602

maniglia Extra anticata

MISURA	imp. 74 mm
FINITURA	PCH C/FIORE
IMBALLO	25



art. 3.2603

maniglia Extra anticata

MISURA	imp. 74 mm
FINITURA	PBN F. BLU
IMBALLO	25



art. 3.2606

maniglia Extra anticata

MISURA	imp. 74 mm
FINITURA	PBN F. MARRONE
IMBALLO	25



art. 3.2607

maniglia Extra anticata

MISURA	imp. 74 mm
FINITURA	PBN F. MIOSOTIS
IMBALLO	25



art. 3.2608

maniglia Extra anticata

MISURA	imp. 74 mm
FINITURA	PCH/ANT
IMBALLO	25



art. 3.3000

maniglia Stile

MISURA	imp. 96 mm
FINITURA	PBN/Z. ANT
IMBALLO	25



art. 3.3001

maniglia Stile z. anticata

MISURA	imp. 96 mm
FINITURA	PBN MELA VERDE
IMBALLO	25



art. 3.3002

maniglia Stile z. anticata

MISURA	imp. 96 mm
FINITURA	PCH C/FIORE
IMBALLO	25



art. 3.3003

maniglia Stile z. anticata

MISURA	imp. 96 mm
FINITURA	PBN F. BLU
IMBALLO	25



art. 3.3006

maniglia Stile z. anticata

MISURA	imp. 96 mm
FINITURA	PBN F. MARRONE
IMBALLO	25



art. 3.3007

maniglia Stile z. anticata

MISURA	imp. 96 mm
FINITURA	PCH F. MIOSOTIS
IMBALLO	25



art. 3.3008

maniglia Stile

MISURA	imp. 96 mm
FINITURA	PCH/Z. ANT
IMBALLO	25



art. 3.2510

maniglia per mobili

	3.2510.08	3.2510.10	3.2510.12	3.2510.14
MISURA	80 mm	100 mm	120 mm	140 mm
FINITURA	OLV	OLV	OLV	OLV
IMBALLO	50	50	50	50
EURO				
FINITURA	CR	CR	CR	CR



art. 3.2520

maniglia Flora

MISURA	160 mm
FINITURA	FUMÈ
IMBALLO	12



art. 3.2535

maniglia scanalata

MISURA	140 mm	140 mm
FINITURA	OLV	BR
IMBALLO	30	30



art. 3.2536

maniglia rigata

MISURA	140 mm	140 mm
FINITURA	OLV	BR
IMBALLO	30	30



art. 3.2580

maniglia liscia

MISURA	150 mm
FINITURA	OLV
IMBALLO	12



art. 3.2585

maniglia decorata

MISURA	125 mm
FINITURA	OLV
IMBALLO	12



art. 3.2590

maniglia Conchiglia rigata

MISURA	74X36 mm	74X36 mm
FINITURA	OLV	ANT
IMBALLO	25	25



art. 3.2595

maniglia Conchiglia liscia

MISURA	84X36 mm	84X36 mm
FINITURA	OLV	CRS
IMBALLO	25	25



art. 3.2610

maniglia Rialto

	3.2610.06	3.2610.09
MISURA	64 mm	96 mm
FINITURA	OLV	OLV
IMBALLO	25	25

FINITURA OGR OGR

FINITURA CR CR

FINITURA CRS CRS

art. 3.2615

maniglia Bastoncino

	3.2615.06	3.2615.09	3.2615.12
MISURA	64 mm	96 mm	128 mm
FINITURA	OLV	OLV	OLV
IMBALLO	25	25	25

FINITURA OGR OGR OGR

FINITURA CR CR CR

FINITURA CRS CRS CRS



art. 3.2620

maniglia Firenze

MISURA	115 mm	145 mm	220 mm
FINITURA	FERRO NR	FERRO NR	FERRO NR
IMBALLO	12	12	12

art. 3.2630

maniglia Rustica

MISURA	150 mm
FINITURA	FERRO NR
IMBALLO	24



art. 3.2633

maniglia Twist

	3.2633.30	3.2633.40
MISURA	ø 30 mm	ø 40 mm
FINITURA	FERRO NR	FERRO NR
IMBALLO	25	25



art. 3.2635

maniglia Basket

MISURA	125 mm
FINITURA	FERRO NR
IMBALLO	12



art. 3.2640

maniglia Ponte

	3.2640.I0	3.2640.I2	3.2640.I5
MISURA	100 mm	125 mm	150 mm
FINITURA	OLV	OLV	OLV
IMBALLO	25	25	25

FINITURA	BR	BR	BR
----------	----	----	----

FINITURA	CR	CR	CR
----------	----	----	----

FINITURA	CRS	CRS	CRS
----------	-----	-----	-----



art. 3.2645

maniglia Biemme

	3.2645.I0	3.2645.I5
MISURA	100 mm	150 mm
FINITURA	OLV	OLV
IMBALLO	25	25

FINITURA	CR	CR
----------	----	----



art. 3.2660

maniglia Bridge - int. 32 mm

	50x20 mm	50x20 mm	50x20 mm	50x20 mm
MISURA				
FINITURA	OLV	BR	CR	CRS
IMBALLO	30	30	30	30



art. 3.2695

maniglia Geco con viti in vista

	125 mm	125 mm	125 mm
MISURA			
FINITURA	OLV	CR	CRS
IMBALLO	25	25	25



art. 3.3010

maniglia Linea ø 12 mm

	3.3010.12	3.3010.16	3.3010.22	3.3010.28
MISURA	128 mm	160 mm	224 mm	288 mm
FINITURA	INOX	INOX	INOX	INOX
IMBALLO	12	12	12	12



art. 3.3020

maniglia Poros

	3.3020.09	3.3020.12
MISURA	96 mm	128 mm
FINITURA	Z. NIK SAT	Z. NIK SAT
IMBALLO	12	12



art. 3.3030

maniglia Punto

	3.3030.09	3.3030.12
MISURA	96 mm	128 mm
FINITURA	Z. NIK SAT	Z. NIK SAT
IMBALLO	12	12



art. 3.3040

maniglia Fox

	3.3040.09	3.3040.12
MISURA	96 mm	128 mm
FINITURA	Z. NIK SAT	Z. NIK SAT
IMBALLO	12	12



art. 3.3050

maniglia Antigone

	3.3050.09	3.3050.12
MISURA	96 mm	128 mm
FINITURA	Z. NIK SAT	Z. NIK SAT
IMBALLO	12	12

art. 3.5010

maniglione Capri zancato
rosetta ø 50 mm - interasse 170 mm

FINITURA	OLV
IMBALLO	2



art. 3.5000

maniglione Capri diritto
rosetta ø 50 mm - interasse 170 mm

FINITURA	OLV	OGR
IMBALLO	2	2



art. 3.5020

maniglione Ibiza diritto
rosetta ø 45 mm - interasse 150 mm

FINITURA	OLV	CRS
IMBALLO	2	2

art. 3.5020

maniglione Ibiza diritto
rosetta ø 45 mm - interasse 200 mm

FINITURA	OLV	CRS
IMBALLO	2	2



art. 3.5050maniglione Impero
interasse 200 mm

FINITURA	OLV	OGR
IMBALLO	2	2

art. 3.5050maniglione Impero
interasse 300 mm

FINITURA	OLV	OGR
IMBALLO	2	2

art. 3.5060maniglione Urano
interasse 200 mm

FINITURA	OLV	OGR
IMBALLO	2	2

art. 3.5060maniglione Urano
interasse 300 mm

FINITURA	OLV	OGR
IMBALLO	2	2

**art. 3.5070**maniglione Rodi
interasse 150 mm

FINITURA	OLV	OGR
IMBALLO	2	2

art. 3.5070maniglione Rodi
interasse 200 mm

FINITURA	OLV	OGR
IMBALLO	2	2

art. 3.5040

maniglione Brigi decentrato
placca foro yale dx e sx

FINITURA	OLV
IMBALLO	2



art. 3.5280

maniglione Omega
placca Hotel 278x57 mm

FINITURA	OLV	CRS
IMBALLO	2	2



art. 3.5100

maniglione Imperial
placca - interasse 235 mm

FINITURA	OLS	CR/CRS
IMBALLO	2	2



art. 3.5080

maniglione Venezia diritto
rosetta ø 45 mm - interasse 220 mm

FINITURA	OLV	OGR	ARG ANT
IMBALLO	2	2	2



art. 3.5270

maniglione Flower
interasse 200 mm

FINITURA	OLV
IMBALLO	4



art. 3.5090

maniglione Georgian
rosetta ø 45 mm - viti in vista
interasse 155 mm

FINITURA	OLV
IMBALLO	2



art. 3.5260

maniglione Garda con rosetta ø 45 mm
interasse variabile da 170 a 205 mm

FINITURA	OLV	OGR
IMBALLO	2	2

**art. 3.5290**

maniglione Desy rigato
rosetta ø 50 mm
interasse 185 mm

FINITURA	OLV	OGR
IMBALLO	2	2

FINITURA	CR	CRS
----------	----	-----

**art. 3.5380**

maniglione Thay
interasse 185 mm

FINITURA	OLV
IMBALLO	2



art. 3.5140

maniglione Pireo **bicolore**
 interasse 180 mm
 rosetta ø 40 mm - perno filettato
 oppure rosetta ø 45 mm - sottoplastica

FINITURA	OLV/SAT	CR/CRS
IMBALLO	2	2

art. 3.5140

maniglione Pireo **monocolore**
 interasse 180 mm
 rosetta ø 40 mm - perno filettato
 oppure rosetta ø 45 mm - sottoplastica

FINITURA	OLV	OGR	SAT	CRS
IMBALLO	2	2	2	2



art. 3.5470

maniglione Pireo zancato **bicolore**
 rosetta ø 40 mm - interasse 185 mm

FINITURA	OLV/SAT	CR/CRS
IMBALLO	2	2

art. 3.5470

maniglione Pireo zancato **monocolore**
 rosetta ø 40 mm - interasse 185 mm

FINITURA	OLV	OGR	SAT	CR	CRS
IMBALLO	2	2	2	2	2

art. 3.5240

maniglione Colonia
 rosetta ø 50 mm - interasse 185 mm

FINITURA	OLV
IMBALLO	2

**art. 3.5250**

maniglione Olaria
 rosetta ø 50 mm
 interasse 200 mm

FINITURA	OLV
IMBALLO	2

**art. 3.5230**

maniglione Desy
 rosetta ø 50 mm
 interasse 185 mm

FINITURA	OLV	OGR
IMBALLO	2	2

FINITURA	CR	CRS
----------	----	-----



art. 3.5412

maniglione Corinne
 rosetta ø 45 mm - viti in vista
 interasse 225 mm

FINITURA	OLV	ANT	CR
IMBALLO	2	2	2

FINITURA	CRS	ORO ANT	ARG ANT
----------	-----	---------	---------

**art. 3.5512**

maniglione Liberty
 rosetta ø 45 mm - viti in vista
 interasse 225 mm

FINITURA	OLV	ANT	CRS
IMBALLO	2	2	2

FINITURA	ORO ANT	ARG ANT
----------	---------	---------

**art. 3.5612**

maniglione Lyon
 rosetta ø 45 - viti in vista
 interasse 225 mm

FINITURA	OLV	ANT	CRS
IMBALLO	2	2	2

FINITURA	ORO ANT	ARG ANT
----------	---------	---------

art. 3.5340

maniglione Porto diritto
rosetta ø 50 mm - interasse 200 mm

FINITURA	OLV	OGR	ARG ANT	PVD
IMBALLO	2	2	2	2



art. 3.5350

maniglione Porto zancato
rosetta ø 50 mm - interasse 200 mm

FINITURA	OLV	OGR	ARG ANT	PVD
IMBALLO	2	2	2	2

art. 3.5360

maniglione Clara diritto
 rosetta ø 50 mm
 interasse 180 mm

FINITURA	OLV	OGR
IMBALLO	2	2

FINITURA	CR	CRS
----------	----	-----

**art. 3.5330**

maniglione Cometa
 rosetta ø 50 mm
 interasse 210 mm

FINITURA	OLV	OGR
IMBALLO	2	2

FINITURA	CR	CRS
----------	----	-----

**art. 3.5370**

maniglione Silvia dritto rigato
 rosetta ø 50 mm
 interasse 180 mm

FINITURA	OLV	OGR
IMBALLO	2	2

FINITURA	CR	CRS
----------	----	-----



art. 3.5450

maniglione Luxor
rosetta ø 50 mm - interasse 195 mm

FINITURA	OLV/SAT	CR/CRS
IMBALLO	2	2



art. 3.5400

maniglione Pegaso
rosetta ø 50 mm - interasse 250 mm

FINITURA	OLV	SAT	OGR	CR	CRS	PVD
IMBALLO	2	2	2	2	2	2

art. 3.5624.24

maniglione Eos
placca 240x42 mm
interasse 220 mm

FINITURA	OLV	ORO ANT
IMBALLO	2	2



art. 3.5659

maniglione Eos
rosetta ø 50 mm con bordo
interasse 170 mm

FINITURA	OLV	ORO ANT
IMBALLO	2	2



SISTEMA DI FISSAGGIO SLIK



art. 3.5660 SL

maniglione Samba
interasse 195 mm - **fissaggio slik**

FINITURA	OLV	SAT	CRS
IMBALLO	2	2	2

art. 3.5660

maniglione Samba
rosetta ø 50 mm
interasse 195 mm

FINITURA	OLV	SAT	CRS
IMBALLO	2	2	2





art. 3.5640

maniglione Riccio
rosetta ø 50 mm - interasse 245 mm

FINITURA	OLV	OGR	CRS	PVD
IMBALLO	2	2	2	2



art. 3.5220

maniglione Vienna
interasse 210 mm

FINITURA	OLV	BR
IMBALLO	2	2

SISTEMA DI FISSAGGIO SLIK



art. 3.5480

maniglione Elly Bic
interasse 220 mm - **fissaggio slik**

FINITURA	OLV/SAT	CR/CRS
IMBALLO	2	2



art. 3.5530 SL

maniglione Laura
fissaggio slik

FINITURA	CR/CRS	CR/CRS	CR/CRS	CR/CRS	CR/CRS
IMBALLO	2	2	2	1	1
INT. mm	200	250	300	400	500

art. 3.5530

maniglione Laura
rosetta quadra 50X50 mm
interasse 200 mm

FINITURA	OLV/SAT	CR/CRS
IMBALLO	2	2



art. 3.5490

maniglione Esse
interasse 240 mm - **fissaggio slik**

FINITURA	OLV	SAT	OGR
IMBALLO	2	2	2

FINITURA	CR	CRS	PVD
----------	----	-----	-----



art. 3.5590

maniglione Sandy
rosetta quadra 50x50 mm
interasse 160 mm

FINITURA	Z. CR/NIK
IMBALLO	2



art. 3.5540

maniglione Cris inox
rosetta ø 50 mm
interasse 200 mm

FINITURA	NIK/CR	PVD
IMBALLO	2	2

SISTEMA DI FISSAGGIO SLIK



art. 3.5910

maniglione Lotus
fissaggio slik

FINITURA	CR/CRS	CR/CRS	CR/CRS	CR/CRS
IMBALLO	2	2	1	1
INT. mm	200	300	400	500



art. 3.5670

maniglione Arco
interasse 240 mm - fissaggio slik

FINITURA	OLV	OGR	CRS	PVD
IMBALLO	2	2	2	2



art. 3.5690

maniglione Pilar
rosetta quadra 50X50 mm
interasse 200 mm

FINITURA	OLV	OGR OP	CR/CRS
IMBALLO	2	2	2



SISTEMA DI FISSAGGIO SLIK



art. 3.5680 SL

maniglione Pilar
interasse 200 mm - **fissaggio slik**

FINITURA	OLV	CR	CRS
IMBALLO	2	2	2

art. 3.5680

maniglione Pilar
rosetta ø 50 mm - interasse 200 mm

FINITURA	OLV	OGR OP	CR/CRS
IMBALLO	2	2	2



art. 3.5930

maniglione zama Cosmo
completo di kit di montaggio
interasse 205 mm

FINITURA	CRS
IMBALLO	2



SISTEMA DI MONTAGGIO



art. 3.5920

maniglione Kubik
fissaggio slik

FINITURA	CR/CRS	CR/CRS	CR/CRS	CR/CRS
IMBALLO	2	2	1	1
INT. mm	200	300	400	500



art. 3.5165.16

maniglione Sonia in porcellana bianca
rosetta Lux ø 45 mm - interasse 140 mm

art. 3.5165.26

maniglione Sonia in porcellana bianca
rosetta Lux ø 45 mm - interasse 225 mm

FINITURA	OLV	ANT
IMBALLO	2	2



art. 3.5175.16

maniglione Gemma in porcellana champagne decorata
rosetta Lux ø 45 mm - interasse 140 mm

art. 3.5175.26

maniglione Gemma in porcellana champagne decorata
rosetta Lux ø 45 mm - interasse 225 mm

FINITURA	OLV	ANT
IMBALLO	2	2



art. 3.5185.16

maniglione Lara in porcellana champagne
con rosetta Lux ø 45 mm - interasse 140 mm

art. 3.5185.26

maniglione Lara in porcellana champagne
con rosetta Lux ø 45 mm - interasse 225 mm

FINITURA	OLV	ANT
IMBALLO	2	2



art. 3.5195.16

maniglione Anna in porcellana bianca decorata
rosetta Lux ø 45 mm - interasse 140 mm

art. 3.5195.26

maniglione Anna in porcellana bianca decorata
rosetta Lux ø 45 mm - interasse 225 mm

FINITURA	OLV	ANT
IMBALLO	2	2



art. 3.5325.16

maniglione Sonia Blu in porcellana bianca
decorata c/fiore blu rosetta Lux ø 45 mm - interasse 140 mm

art. 3.5325.26

maniglione Sonia Blu in porcellana bianca
decorata c/fiore blu rosetta Lux ø 45 mm - interasse 225 mm

FINITURA	OLV	ANT
IMBALLO	2	2

MANIGLIONI INOX

art. 3.5770

maniglione linea **dritto**
con possibilità di lunghezze speciali su richiesta

MISURA INT.	210 mm	300 mm	300 mm
MISURA LUNGH.	300 mm	400 mm	500 mm
FINITURA	INOX SAT	INOX SAT	INOX SAT
IMBALLO	2	2	2

MISURA INT.	400 mm	600 mm	900 mm
MISURA LUNGH.	600 mm	800 mm	1200 mm

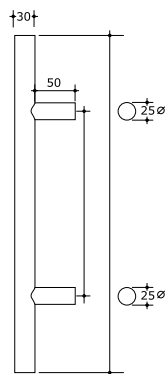

art. 9.0300

kit di montaggio
per maniglioni singolo



art. 9.0310

kit di montaggio per maniglioni
accoppiati per porte a vetro - art. 3.5770



art. 9.0320

kit di montaggio per maniglioni
accoppiati per porte a vetro - art. 3.5780

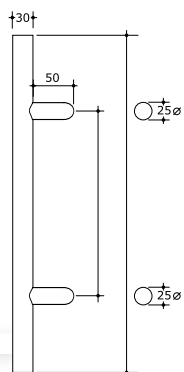

art. 3.5780

maniglione linea **decentrato**
con possibilità di lunghezze speciali su richiesta

MISURA INT.	210 mm	300 mm	300 mm
MISURA LUNGH.	300 mm	400 mm	500 mm
FINITURA	INOX SAT	INOX SAT	INOX SAT
IMBALLO	2	2	2

MISURA INT.	400 mm	600 mm	900 mm
MISURA LUNGH.	600 mm	800 mm	1200 mm



art. 3.5710

coppia maniglioni
 ø 32x350x1,5 mm

FINITURA	INOX SAT
IMBALLO	1

art. 3.5710.OIS

maniglione singolo
 ø 32x350x1,5 mm

FINITURA	INOX SAT
IMBALLO	2



art. 3.5720

coppia maniglioni
 ø 32x350x1,5 mm

FINITURA	INOX SAT
IMBALLO	1

art. 3.5720.OIS

maniglione singolo
 ø 32x350x1,5 mm

FINITURA	INOX SAT
IMBALLO	2



art. 3.5730

coppia maniglioni
 ø 32x350x1,5 mm

FINITURA	INOX SAT
IMBALLO	1

art. 3.5730.OIS

maniglione singolo
 ø 32x350x1,5 mm

FINITURA	INOX SAT
IMBALLO	2



art. 3.5740

coppia maniglioni
 ø 32x350x1,5 mm

FINITURA	INOX SAT
IMBALLO	1

art. 3.5740.OIS

maniglione singolo
 ø 32x350x1,5 mm

FINITURA	INOX SAT
IMBALLO	2



art. 3.5750

coppia maniglioni
 ø 32x350x1,5 mm

FINITURA	INOX SAT
IMBALLO	1

art. 3.5750.OIS

maniglione singolo
 ø 32x350x1,5 mm

FINITURA	INOX SAT
IMBALLO	2



art. 3.5760

coppia maniglioni
 ø 32x350x1,5 mm

FINITURA	INOX SAT
IMBALLO	1

art. 3.5760.OIS

maniglione singolo
 ø 32x350x1,5 mm

FINITURA	INOX SAT
IMBALLO	2



art. 3.5800

coppia maniglione a scatto
per alzanti scorrevoli h. 62 - 258 mm

FINITURA	OLV	OGR	CRS
IMBALLO	1	1	1



art. 3.5900

maniglione singolo a scatto
per alzanti scorrevoli singoli h. 62 - 258 mm

FINITURA	OLV	OGR	CRS
IMBALLO	2	2	2

SISTEMA DI FISSAGGIO SLIK



art. 3.5430

manettoncino Iber
interasse 200 mm - **fissaggio slik**

FINITURA	OLV	SAT	CRS
IMBALLO	6	6	6



art. 3.2690.16

manettoncino Slik
interasse 160 mm - **fissaggio slik**

FINITURA	OLV	OGR	CRS
IMBALLO	6	6	6

art. 3.2690.20

manettoncino Slik
interasse 200 mm - **fissaggio slik**

FINITURA	OLV	OGR	CRS
IMBALLO	6	6	6

SISTEMA DI FISSAGGIO SLIK



art. 3.5620 BIC

manettoncino Flexa **bicolore**
interasse 200 mm - **fissaggio slik**

FINITURA	OLV/SAT	CR/CRS
IMBALLO	6	6

art. 3.5620

manettoncino Flexa **monocolore**
interasse 200 mm - **fissaggio slik**

FINITURA	OLV	OGR
IMBALLO	6	6



art. 3.5630 BIC

manettoncino Clara **bicolore**
interasse 200 mm - **fissaggio slik**

FINITURA	OLV/SAT	CR/CRS
IMBALLO	6	6

art. 3.5630

manettoncino Clara **monocolore**
interasse 200 mm - **fissaggio slik**

FINITURA	OLV	OGR
IMBALLO	6	6



art. 3.2550

manettoncino Gaudel
rosetta ø 40 mm - interasse 150 mm

FINITURA	OLV	OGR	SAT	CR	CRS	ORO ANT
IMBALLO	6	6	6	6	6	6



art. 3.2670

manettoncino Nike
placca sagomata 102x48 mm

FINITURA	OLV	ANT
IMBALLO	2	2



SISTEMA DI FISSAGGIO SLIK



art. 3.2680

manettoncino Duna
interasse 155 mm - fissaggio slik

FINITURA	OLV	OGR	CRS
IMBALLO	6	6	6



art. 7.4210

battente Maxi Leone
 ø 200 mm

FINITURA	OLV	ORO ANT
IMBALLO	1	1



art. 7.4280

battente Mare
 125x110 mm

FINITURA	OLV	OGR
IMBALLO	2	2



art. 7.4010

battente Barocco

	7.4010.I2	7.4010.I5
MISURA	120 mm	150 mm
FINITURA	OLV	OLV
IMBALLO	2	2
FINITURA	ANT	ANT



art. 7.4013

battente Leoncino
160x90 mm

FINITURA	OLV	ANT	VERDE VENEZ.
IMBALLO	2	2	2



art. 7.4015

battente Leone
200x100 mm

FINITURA	OLV	ANT
IMBALLO	2	2



art. 7.4020

battente Esagonale

7.4020.10 7.4020.12

MISURA	100 mm	120 mm
FINITURA	OLV	OLV
IMBALLO	2	2



art. 7.4024.09

battente Lira
100x190 mm

FINITURA	OLV	ANT
IMBALLO	2	2



art. 7.4027

battente America
135 mm

FINITURA	OLV
IMBALLO	2



art. 7.4030

battente Roma
180 mm

FINITURA	OLV
IMBALLO	2



art. 7.4110

battente Anello

	7.4110.09	7.4110.11	7.4110.13
MISURA	90 mm	110 mm	130 mm
FINITURA	OLV	OLV	OLV
IMBALLO	2	2	2

FINITURA	OGR	OGR	OGR
----------	-----	-----	-----

FINITURA	CRS	CRS	CRS
----------	-----	-----	-----



art. 7.4050

battente Georgian

	7.4050.15	7.4050.20
MISURA	150 mm	200 mm
FINITURA	OLV	OLV
IMBALLO	2	2

FINITURA	OGR	OGR
----------	-----	-----



art. 7.4060

battente Victorian

	7.4060.15	7.4060.20
MISURA	150 mm	200 mm
FINITURA	OLV	OLV
IMBALLO	2	2

FINITURA	OGR	OGR
----------	-----	-----



art. 7.4040

battente Regal
140 mm

FINITURA	OLV
IMBALLO	2



art. 7.4075

battente Manina media
110x60 mm

FINITURA	OL	ANT
IMBALLO	2	2



art. 7.4130

battente Cavallo
140x120 mm

FINITURA	ANT
IMBALLO	2



art. 7.4140

battente Maya
160x95 mm

FINITURA	ANT
IMBALLO	2



art. 7.4150

battente Medusa
165x120 mm

FINITURA	OL	ANT
IMBALLO	2	2



art. 7.4160

battente Impero
125x100 mm

FINITURA	OL	ANT
IMBALLO	2	2



art. 7.4170

battente Leone big
270x150 mm

FINITURA	OL
IMBALLO	1

art. 7.4180

battente York
110 mm

FINITURA	OLV
IMBALLO	2



art. 7.4190

battente Porto
120 mm

FINITURA	OLV	CRS	OGR	ARG ANT
IMBALLO	2	2	2	2



art. 7.4200

battente Ring
110 mm

FINITURA	OLV	CRS	OGR
IMBALLO	2	2	2



art. 7.4220

battente Luxor
115 mm

FINITURA	OLV
IMBALLO	2



art. 7.4230

battente Denz
ø 117 mm

FINITURA	FERRO NR
IMBALLO	2



art. 7.4240

battente Basket
117 mm

FINITURA	FERRO NR
IMBALLO	2



art. 7.4250

battente Kora
ø 113 mm

FINITURA	FERRO NR
IMBALLO	2



art. 7.4260

battente Delfino
140 mm

FINITURA	OLV	CR
IMBALLO	2	2



art. 7.4290

battente Goccia
140x65 mm

FINITURA	OLV	ORO ANT
IMBALLO	2	2

Serie CITOFONI e CAMPANELLI



art. 7.2000.01

targa citofono a 1 pulsante 265x130 mm

FINITURA	OL
IMBALLO	1

art. 7.2000.02

targa citofono a 2 pulsanti 265x130 mm

FINITURA	OL
IMBALLO	1



art. 7.2010.01

campanello a 1 pulsante 80x120 mm

FINITURA	OL
IMBALLO	2

art. 7.2010.02

campanello a 2 pulsanti 80x120 mm

FINITURA	OL
IMBALLO	2



art. 7.2020

campanello Country a 1 pulsante

FINITURA	ANT/OLV
IMBALLO	1



art. 7.2050

campanello Silvia a 1 pulsante
140x72 mm

FINITURA	OLV	ANT
IMBALLO	4	4



art. 7.2051

campanello Silvia senza finestrella
140x72 mm

FINITURA	OLV	ANT
IMBALLO	4	4



art. 7.2053

campanello Ibiza a 1 pulsante
122x73 mm

FINITURA	OLV	OGR	CR	CRS
IMBALLO	4	4	4	4



art. 7.2054

campanello Ibiza senza finestrella
122x73 mm

FINITURA	OLV	OGR	CR	CRS
IMBALLO	4	4	4	4



art. 7.2055

campanello ovale a 1 pulsante
132x72 mm

FINITURA	OLV	ANT
IMBALLO	4	4



art. 7.2056

campanello ovale senza finestrella
132x72 mm

FINITURA	OLV	ANT
IMBALLO	4	4



art. 7.2060

campanello Classic tondo concavo
con bordo ø 75 mm

FINITURA	OL
IMBALLO	2



art. 7.2070

campanello Venezia tondo concavo
con bordo ø 58 mm

FINITURA	OL
IMBALLO	5



art. 7.2080

pulsante per campanello
ø 16x38 mm

FINITURA	OLV	BR	CR
IMBALLO	25	25	25



art. 7.2090

campanello Leoncino
72x70 mm

FINITURA	OLV	ANT
IMBALLO	4	4



art. 7.2100

campanello su rosetta Lux
ø 45 mm

FINITURA	OLV	ANT
IMBALLO	4	4



art. 7.2130

campanello rosetta ovale rigata
30x62 mm

FINITURA	OLV
IMBALLO	5

serie PLACCHE PORTANOME



art. 7.0002

placca portanome Classic ovale

	7.0002	7.0003	7.0004	7.0005	7.0006
MISURA	120x60 mm	140x70 mm	180x90 mm	220x130 mm	330x200 mm
FINITURA	OLV	OLV	OLV	OLV	OLV
IMBALLO	10	10	5	2	1



art. 7.0011

placca portanome Capri
ovale bombata, **leggero** 140x70 mm

FINITURA	OLV
IMBALLO	10

art. 7.0010

placca portanome Capri
ovale bombata, **pesante** 140x70 mm

FINITURA	OLV
IMBALLO	10



art. 7.0020

placca portanome Vesuvio
ovale leggero

	7.0020	7.0021
MISURA	120x60 mm	80x40 mm
FINITURA	OLV	OLV
IMBALLO	10	10



art. 7.0030

placca portanome Ala
135x50 mm

FINITURA	OLV
IMBALLO	10



art. 7.0050

placca portanome Trieste
135x46 mm

FINITURA	OLV
IMBALLO	10



art. 7.0060

placca portanome Ring
105x38 mm

FINITURA	OLV
IMBALLO	10



art. 7.0070

placca portanome Trento
170x58 mm

FINITURA	OLV
IMBALLO	10



art. 7.0100

placca portanome Star
110x40 mm

FINITURA	OLV
IMBALLO	10



art. 7.0110

placca portanome Todi
82x46 mm

FINITURA	OLV
IMBALLO	20

serie **TARGHETTE**



art. 0.0716

targhetta figura uomo
100x40 mm

FINITURA	OLV
IMBALLO	12



art. 0.0717

targhetta figura donna
100x40 mm

FINITURA	OLV
IMBALLO	12



art. 0.0720

targhetta bagno
130x40 mm

FINITURA	OLV
IMBALLO	10



art. 0.0730

targhetta bagno
100x50 mm

FINITURA	OLV
IMBALLO	10

BUCALETTERE

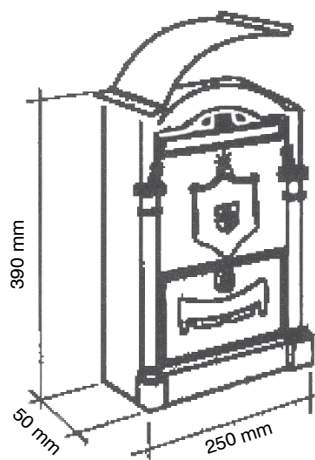

art. 7.3000

cassetta poste
390x250x50 mm

FINITURA	OLV	BR
IMBALLO	1	1

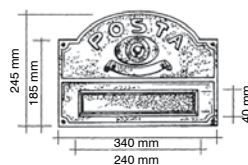

art. 7.3050

bucallettere serie Florence

FINITURA	OL	ANT
IMBALLO	1	1



art. 7.3055

sportello da incasso
286x286 mm

FINITURA	OL	ANT
IMBALLO	1	1



art. 7.3150

bucal lettere Old
300x130 mm

FINITURA	OLV	ANT
IMBALLO	1	1



art. 7.3120

bucal lettere Georgian

	7.3120.01	7.3120.02
MISURA	254x75 mm	280x90 mm
FINITURA	OLV	OLV
IMBALLO	1	1



art. 7.3130

bucal lettere Big Gravity Style
310x80 mm - int. 280x40 mm

FINITURA	FUMÈ
IMBALLO	1



art. 7.3140

bucallettere Victorian

	7.3140.01	7.3140.01	7.3140.01	7.3140.01	7.3140.02	7.3140.03
MISURA	254x75 mm	254x75 mm	254x75 mm	254x75 mm	280x100 mm	300x100 mm
FINITURA	OLV	OGR	CR	CRS	OLV	OLV
IMBALLO	1	1	1	1	1	1



art. 7.3145

bucallettere Gravity
254x75 mm

FINITURA	OLV	OGR	CR	CRS
IMBALLO	1	1	1	1



art. 7.3147

bucallettere Big Gravity
330x80 mm - int. 265x43 mm

FINITURA	OLV	OGR	SAT	CR	CRS	PVD
IMBALLO	1	1	1	1	1	1



art. 7.3160

bucal lettere
254X75 mm

FINITURA	OLV/SAT	NR/SAT
IMBALLO	1	1



art. 7.3170

bucal lettere
350X90 mm

FINITURA	FERRO NR
IMBALLO	1



art. 7.3180

bucal lettere Queen
275x80 mm - int. 210x40 mm

FINITURA	OLV	OGR	CR	CRS
IMBALLO	1	1	1	1



art. 7.3185

bucal lettere King
275x80 mm - int. 210x40 mm

FINITURA	OLV	ANT	OGR	CRS
IMBALLO	1	1	1	1

BASE PER NUMERI

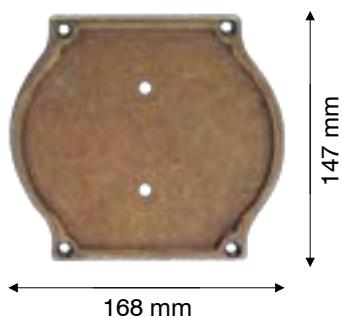

art. 9.1050.01

base per 1 numero

FINITURA	ANT
IMBALLO	2

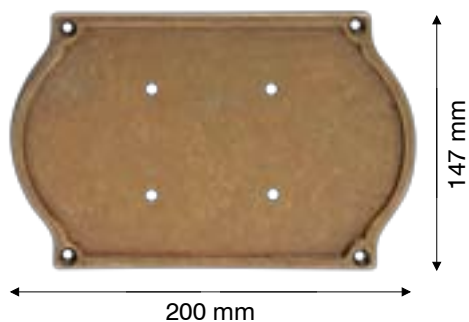

art. 9.1050.02

base per 2 numeri

FINITURA	ANT
IMBALLO	2



art. 9.1050.03

base per 3 numeri

FINITURA	ANT
IMBALLO	2

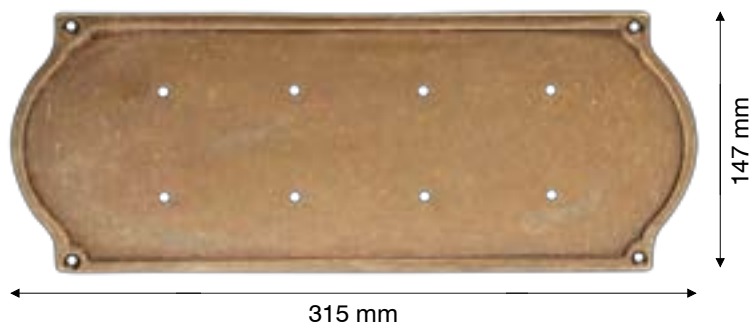

art. 9.1050.04

base per 4 numeri

FINITURA	ANT
IMBALLO	2



art. 9.1060

numero civico Lux
78x60 mm

FINITURA	ANT/OLV
IMBALLO	4



art. 9.0910

lettere - **alfabeto completo**
50 mm con pioli

FINITURA	OLV
IMBALLO	10

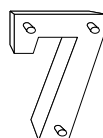

art. 9.0915

numero civico
50 mm con pioli

FINITURA	OLV
IMBALLO	10



art. 9.0920

numero civico
125 mm con fori

FINITURA	OLV
IMBALLO	10



art. 9.0930

numero civico
50 mm con fori

FINITURA	OLV
IMBALLO	10



art. 9.0940

numero civico
150 mm con chiodo filettato 5 ma e tassello

FINITURA	OLV
IMBALLO	10



art. 9.0945

numero civico
100 mm con chiodo filettato 5 ma e tassello

FINITURA	OLV
IMBALLO	10

A B C D 0 2 3

art. 9.0948

lettere - solo A B C D
50 mm

FINITURA	FERRO NR
IMBALLO	10

art. 9.0950

numero civico con fori
75 mm

FINITURA	FERRO NR
IMBALLO	10



art. 9.0960

numero civico inglese
75 mm con fori

FINITURA	OLV
IMBALLO	10



art. 9.0980

numero civico martellato
110 mm

FINITURA	NR/ORO
IMBALLO	10



art. 9.0990

numero civico gotico
120 mm

FINITURA	FUMÈ
IMBALLO	10

art. 9.0900

lettera gotica - A B C
80 mm

FINITURA	FUMÈ
IMBALLO	10

COPRIAVVOLGIBILI



art. 4.9505
copriavvolgibile Rettangolare
278x56 mm

FINITURA	OLV	OGR	CRS
IMBALLO	12	12	12



art. 4.9510
copriavvolgibile Eko
240x53 mm

FINITURA	OLV	OGR	CRS	BN
IMBALLO	20	20	20	20



art. 4.9520
copriavvolgibile Silvia
278x54 mm

FINITURA	OLV	OGR	CRS
IMBALLO	12	12	12



art. 4.9530
copriavvolgibile Classic
278x56 mm

FINITURA	OLV	OGR	CRS	BN
IMBALLO	12	12	12	12



art. 4.9540

copriavvolgibile Flora
280x57 mm

FINITURA	BR
IMBALLO	14



art. 4.9550

copriavvolgibile Barocco
280x57 mm

FINITURA	BR
IMBALLO	14



art. 2.0030

placca cieca 278x 56 mm
copriautomazione per tapparelle

FINITURA	OLV	OGR	CRS
IMBALLO	12	12	12

3113 Serie **SCORRICINGHIA**



art. 4.2314

scorricinghia Ovale
35x60 mm

FINITURA	OLV	BR	CRS	BN
IMBALLO	24	24	24	24



art. 4.2315

scorricinghia Rettangolare
60x45 mm

FINITURA	OLV	BR	CRS	BN
IMBALLO	24	24	24	24



art. 4.2316

scorricinghia Lusso
62x52 mm

FINITURA	OLV	BR	CRS	BN
IMBALLO	24	24	24	24

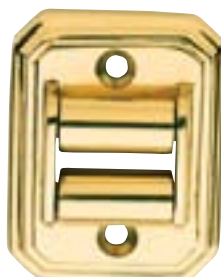

art. 4.2317

scorricinghia Silvia
60x45 mm

FINITURA	OLV	BR
IMBALLO	24	24

COPRINTERRUTTORI

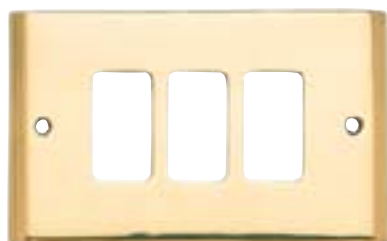

art. 8.2000

coprinterruttore Ibiza 125x74 mm

8.2000.00 8.2000.01-02-03 8.2000.04-05

N° FORI	cieco	1-2-3	4-5
FINITURA	OLV	OLV	OLV
IMBALLO	10	10	10

FINITURA	OGR	OGR	OGR
----------	-----	-----	-----

FINITURA	CRS	CRS	CRS
----------	-----	-----	-----

art. 8.2030

coprinterruttore Classic 132x72 mm

8.2030.00 8.2030.01-02-03 8.2030.04-05

N° FORI	cieco	1-2-3	4-5
FINITURA	OLV	OLV	OLV
IMBALLO	10	10	10

FINITURA	OGR	OGR	OGR
----------	-----	-----	-----

FINITURA	CRS	CRS	CRS
----------	-----	-----	-----

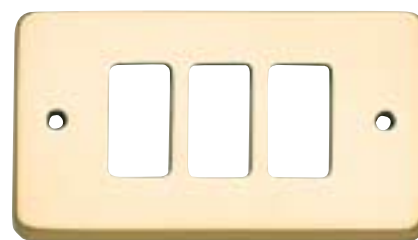

art. 8.2060

coprinterruttore Venezia 145x73 mm

8.2060.01-02-03 8.2060.01-02-03

N° FORI	1-2-3	1-2-3
FINITURA	OLV	ANT
IMBALLO	10	10

art. 8.2090

coprinterruttore Praga 124x70 mm

8.2090.01-02-03 8.2090.04-05

N° FORI	1-2-3	4-5
FINITURA	OLV	OLV
IMBALLO	10	10

FINITURA	OGR	OGR
----------	-----	-----

FINITURA	CRS	CRS
----------	-----	-----



art. 8.2180

coprinterruttore 212 - 135x73 mm

N° FORI	1-2-3
FINITURA	FUMÈ
IMBALLO	10



art. 8.2220

coprinterruttore Giulia 135x72 mm

N° FORI	1-2-3
FINITURA	PBN
IMBALLO	10



art. 8.2240

coprinterruttore 211 - 124x75 mm

N° FORI	1-2-3
FINITURA	FUMÈ
IMBALLO	10



art. 8.2480

coprinterruttore Silvia 140x72 mm

8.2480.00 8.2480.01-02-03

N° FORI	cieco	1-2-3
FINITURA	OLV	OLV
IMBALLO	10	10

FINITURA	ANT	ANT
----------	-----	-----



art. 5.4230

catenaccio orizzontale per spagnolette base 38x13 con incontro

5.4230.20

MISURA 200 mm

FINITURA OTT. VERNICIATO NR

IMBALLO 4



art. 5.4030

catenaccio binario

	5.4030.06	5.4030.08	5.4030.10	5.4030.12
MISURA	60 mm	80 mm	100 mm	120 mm
FINITURA	OL	OL	OL	OL
IMBALLO	50	50	50	50



art. 5.4050

catenaccio sagomato leggero con incontro

	5.4050.05	5.4050.06	5.4050.08
MISURA	50 mm	60 mm	80 mm
FINITURA	OL	OL	OL
IMBALLO	24	24	24

	5.4050.10	5.4050.12	5.4050.14	5.4050.16
MISURA	100 mm	120 mm	140 mm	160 mm
FINITURA	OL	OL	OL	OL
IMBALLO	24	24	24	24

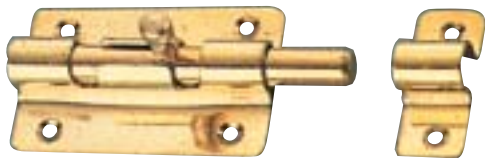

art. 5.4060

catenaccio a cannone con incontro

	5.4060.06	5.4060.08	5.4060.10	5.4060.12
MISURA	60 mm	80 mm	100 mm	120 mm
FINITURA	OL	OL	OL	OL
IMBALLO	24	24	24	24

art. 5.4065

catenaccio a cannone base quadra

	5.4065.06	5.4065.07	5.4065.09
MISURA	60 mm	75 mm	90 mm
FINITURA	OLV	OLV	OLV
IMBALLO	12	12	12



art. 5.4075

catenaccio a cannone rigato con incontro

	5.4075.06	5.4075.07	5.4075.10	5.4075.15
MISURA	60x19 mm	75x19 mm	100x25 mm	150x38 mm
FINITURA	OLV	OLV	OLV	OLV
IMBALLO	24	24	12	6
FINITURA	CR	CR	CR	CR

art. 5.4080

catenaccio tondo con molla

	5.4080.06	5.4080.08	5.4080.10	5.4080.12
MISURA	60 mm	80 mm	100 mm	120 mm
FINITURA	OL	OL	OL	OL
IMBALLO	12	12	12	12



art. 5.4070

catenaccio a binario Lux con incontro

	5.4070.06	5.4070.07
MISURA	60 mm	75 mm
FINITURA	OLV	OLV
IMBALLO	12	12

	5.4070.10	5.4070.12	5.4070.15
MISURA	100 mm	120 mm	150 mm
FINITURA	OLV	OLV	OLV
IMBALLO	12	12	12



art. 5.4110

catenaccio Victoria con incontro

	5.4110.15	5.4110.20
MISURA	150 mm	200 mm
FINITURA	OLV	OLV
IMBALLO	12	12

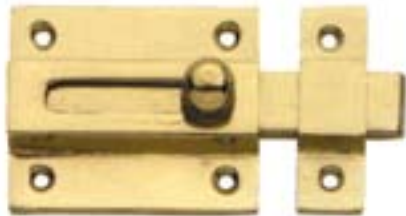

art. 5.4170

catenaccio con chiavistello lungo

	5.4170.08
MISURA	80 mm
FINITURA	OLV
IMBALLO	12



art. 5.4180

catenaccio Rustico in ferro

	5.4180.15	5.4180.20
MISURA	150 mm	200 mm
FINITURA	NR	NR
IMBALLO	12	12



art. 5.4190

catenaccio Flora

	5.4190.15	5.4190.20
MISURA	150 mm	200 mm
FINITURA	BR	BR
IMBALLO	12	12



art. 5.4270

catenaccio Flat con incontro

	5.4270.05	5.4270.06	5.4270.08	5.4270.10
MISURA	50 mm	60 mm	80 mm	100 mm
FINITURA	OLV	OLV	OLV	OLV
IMBALLO	12	12	12	12
EURO				
FINITURA	CR	CR	CR	CR



art. 5.4010

catenaccio verticale

	5.4010.20	5.4010.25
MISURA	200 mm	250 mm
FINITURA	OLV	OLV
IMBALLO	12	12

	5.4010.30	5.4010.40	5.4010.50
MISURA	300 mm	400 mm	500 mm
FINITURA	OLV	OLV	OLV
IMBALLO	12	12	12



art. 5.4100

catenaccio orizzontale con incontro

	5.4100.08	5.4100.10	5.4100.13
MISURA	80 mm	100 mm	130 mm
FINITURA	OLV	OLV	OLV
IMBALLO	12	12	12

	5.4100.17	5.4100.20	5.4100.25	5.4100.30
MISURA	170 mm	200 mm	250 mm	300 mm
FINITURA	OLV	OLV	OLV	OLV
IMBALLO	12	12	12	12



art. 5.4120

catenaccio verticale a puntale

	5.4120.20	5.4120.25	5.4120.30	5.4120.40
MISURA	200 mm	250 mm	300 mm	400 mm
FINITURA	OLV	OLV	OLV	OLV
IMBALLO	12	12	12	12

art. 5.4140

catenaccio a incastro

	5.4140.25	5.4140.30	5.4140.40
MISURA	250 mm	300 mm	400 mm
FINITURA	OLV	OLV	OLV
IMBALLO	12	12	12



art. 5.4150

catenaccio a ginocchio per persiane

	5.4150.20	5.4150.25	5.4150.30	5.4150.40
MISURA	200 mm	250 mm	300 mm	400 mm
FINITURA	OLV	OLV	OLV	OLV
IMBALLO	12	12	12	12

art. 5.4160

catenaccio a coda

	5.4160.25	5.4160.30	5.4160.40
MISURA	250 mm	300 mm	400 mm
FINITURA	OLV	OLV	OLV
IMBALLO	12	12	12



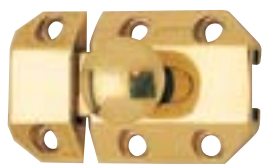

art. 5.4200

catenaccio sfaccettato con incontro

	5.4200.05	5.4200.07	5.4200.10	5.4200.12
MISURA	50 mm	75 mm	100 mm	120 mm
FINITURA	OLV	OLV	OLV	OLV
IMBALLO	12	12	12	12

	5.4200.15	5.4200.20	5.4200.30	5.4200.40
MISURA	150 mm	200 mm	300 mm	400 mm
FINITURA	OLV	OLV	OLV	OLV
IMBALLO	12	12	12	12



art. 5.4250

catenaccio Sigaro

	5.4250.10	5.4250.15
MISURA	114x22 mm	152x22 mm
FINITURA	OLV	OLV
IMBALLO	12	12

FINITURA	CR	CR
----------	----	----



art. 5.4260

catenaccio tubolare con incontro

	5.4260.10	5.4260.15
MISURA	100 mm	150 mm
FINITURA	OLV	OLV
IMBALLO	12	12

FINITURA	OGR	OGR
----------	-----	-----

FINITURA	CR	CR
----------	----	----

FINITURA	CRS	CRS
----------	-----	-----



art. 5.4300

catenaccio tradizionale con incontro

	5.4300.12	5.4300.15	5.4300.20
MISURA	120 mm	150 mm	200 mm
FINITURA	OLV	OLV	OLV
IMBALLO	12	12	12

	5.4300.25	5.4300.30
MISURA	250 mm	300 mm
FINITURA	OLV	OLV
IMBALLO	12	6



art. 5.4350

catenaccio triangolo 110 mm (95+15 mm)

MISURA	110 mm	110 mm
FINITURA	OLV	CR
IMBALLO	12	12



art. 9.0013

catenaccio a cremagliera

	9.0013.08	9.0013.10
MISURA	80 mm	100 mm
FINITURA	OLV	OLV
IMBALLO	2	2



art. 5.4210

catenaccio **orizzontale** stretto
con viti a scomparsa con incontro

	5.4210.15	5.4210.20	5.4210.25	5.4210.30
MISURA	150 mm	200 mm	250 mm	300 mm
FINITURA	OLV	OLV	OLV	OLV
IMBALLO	6	6	6	6
FINITURA	BR	BR	BR	BR
FINITURA	CR e CRS	CR e CRS	CR e CRS	CR e CRS



art. 5.4220

catenaccio **verticale** stretto
con viti a scomparsa con incontro

	5.4220.20	5.4220.25	5.4220.30	5.4220.40
MISURA	200 mm	250 mm	300 mm	400 mm
FINITURA	OLV	OLV	OLV	OLV
IMBALLO	6	6	6	6
FINITURA	BR	BR	BR	BR
FINITURA	CR e CRS	CR e CRS	CR e CRS	CR e CRS



art. 5.4240

catenaccio **verticale** America bivalente con incontro A+B

	5.4240.10	5.4240.15	5.4240.20
MISURA	100 mm	150 mm	200 mm
FINITURA	OLV	OLV	OLV
IMBALLO	6	6	6

	5.4240.25	5.4240.30	5.4240.40	5.4240.60
MISURA	250 mm	300 mm	400 mm	600 mm
FINITURA	OLV	OLV	OLV	OLV
IMBALLO	6	6	6	6



art. 6.0015.00

extra per incontro tipo C per catenaccio America

MISURA	34x29 mm
FINITURA	OLV
IMBALLO	12



art. 5.4280

catenaccio **orizzontale** tondo con incontro

	5.4280.15	5.4280.20	5.4280.25	5.4280.30
MISURA	150 mm	200 mm	250 mm	300 mm
FINITURA	OLV	OLV	OLV	OLV
IMBALLO	4	4	4	4

FINITURA	OGR	OGR	OGR	OGR
----------	-----	-----	-----	-----

FINITURA	CR e CRS	CR e CRS	CR e CRS	CR e CRS
----------	----------	----------	----------	----------



INC A

art. 5.4290

catenaccio **verticale** tondo base 33x13 mm + incontro A o B



INC B

	5.4290.20	5.4290.25	5.4290.30	5.4290.40	INC A	INC B
MISURA	200 mm	250 mm	300 mm	400 mm	INC A	INC B
FINITURA	OLV	OLV	OLV	OLV	OLV	OLV
IMBALLO	4	4	4	4	4	4
FINITURA	OGR	OGR	OGR	OGR	OGR	OGR
FINITURA	CRS	CRS	CRS	CRS	CRS	CRS



art. 5.4360

catenaccio **orizzontale** tondo con incontro

	5.4360.15	5.4360.20	5.4360.25	5.4360.30	5.4360.40
MISURA	150 mm	200 mm	250 mm	300 mm	400 mm
FINITURA	OLV	OLV	OLV	OLV	OLV
IMBALLO	6	6	6	6	6
FINITURA	BR	BR	BR	BR	BR
FINITURA	CR e CRS	CR e CRS	CR e CRS	CR e CRS	CR e CRS



art. 5.4370

catenaccio **verticale** tondo con incontro

	5.4370.20	5.4370.25	5.4370.30	5.4370.40	5.4370.50	5.4370.60
MISURA	200 mm	250 mm	300 mm	400 mm	500 mm	600 mm
FINITURA	OLV	OLV	OLV	OLV	OLV	OLV
IMBALLO	6	6	6	6	6	6
FINITURA	BR	BR	BR	BR	BR	BR
FINITURA	CR e CRS	CR e CRS	CR e CRS	CR e CRS	CR e CRS	CR e CRS

CHIAVISTELLI



art. 5.4175

chiavistello wc
con visualizzatore L/o rosso/verde 62x39 mm

FINITURA	OLV	CR
IMBALLO	5	5

art. 6.0190

mini chiavistello

FINITURA	OLV	CR
IMBALLO	30	30



art. 6.0195

chiavistello con bordo
40x45 mm

FINITURA	OLV
IMBALLO	30

art. 6.0220

chiavistello corto
per bagno tipo pesante 45x45 mm

FINITURA	OLV	NIK
IMBALLO	24	24

art. 6.0290

chiavistello corto
per bagno tipo leggero 45x35 mm

FINITURA	OLV	NIK
IMBALLO	24	24

LUCCHETTI e CHIUDIPIORTA

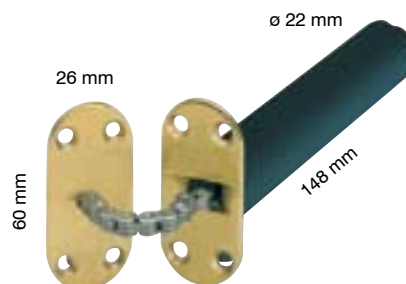

art. 3.4000

lucchetti in ottone con tre chiavi

	3.4000.02	3.4000.03	3.4000.04	3.4000.05	3.4000.06
MISURA	20 mm	30 mm	40 mm	50 mm	60 mm
FINITURA	OLV	OLV	OLV	OLV	OLV
IMBALLO	12	12	12	12	12

art. 6.5050

chiudiporta a scomparsa
con portata ideale di 50 kg

MISURA	60x26x148 - ø 22 mm
FINITURA	OLV
IMBALLO	1

PARACOLPI e FERMAPORTA



art. 6.0040

paracolpi a chiocciola per porta
ø 50 mm - h. 30 mm

FINITURA	OLV	OGR	CRS	BN	NR
IMBALLO	20	20	20	20	20

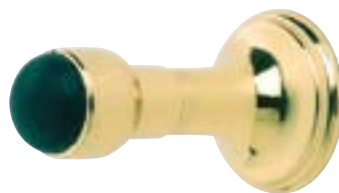

art. 6.0045

paracolpi a muro
ø 40 mm - h. 71 mm

FINITURA	OLV
IMBALLO	12



art. 6.0900

paracolpi ovale
80 mm

FINITURA	OLV
IMBALLO	6



art. 6.0910

paracolpi ovale
40 mm

FINITURA	OLV
IMBALLO	12



art. 6.0920

paracolpi conchiglia
80 mm

FINITURA	OLV
IMBALLO	12



art. 6.0930

paracolpi universale
h. 24 mm - larghezza 38 mm - lunghezza 38 mm

FINITURA	OLV	CR	BZ	NIK.M	BN	NR
IMBALLO	20	20	20	20	20	20



art. 6.0940

paracolpi Cono
ø 50 mm - h. 27 mm

FINITURA	OLV	BZ	CR	CRS
IMBALLO	25	25	25	25



art. 6.0945

paracolpi Goccia
h. 27 mm - larghezza 24 mm - lunghezza 55 mm

FINITURA	OLV	BZ	CR	CRS
IMBALLO	25	25	25	25



art. 6.0950

paracolpi sfera grande
ø 34x34 mm

FINITURA	OLV	OGR	CR	CRS
IMBALLO	12	12	12	12



art. 6.0960

paracolpi ottone massiccio tipo lusso
ø 30 mm - h. 45 mm

FINITURA	OLV	CR	CRS
IMBALLO	12	12	12



art. 6.0999

paracolpi sferico
ø 24 mm - h. 28 mm

FINITURA	OLV	OGR	CR	CRS
IMBALLO	25	25	25	25



art. 6.1000

paracolpi ondulato
ø 24 mm - h. 22 mm

FINITURA	OLV	OGR	CR	CRS
IMBALLO	25	25	25	25



art. 6.0970

fermaporta magnetico
leggero

FINITURA	OLV	NIK
IMBALLO	12	12

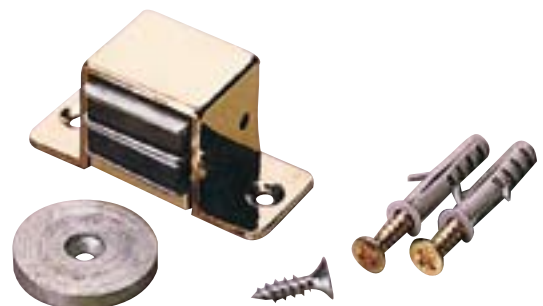

art. 6.0980

fermaporta magnetico
pesante

FINITURA	OLV	NIK
IMBALLO	12	12

serie BLOCCAPERSIANE



art. 6.0010

gancio fermapersiane

	6.0010.06	6.0010.08	6.0010.10	6.0010.12	6.0010.14	6.0010.20
MISURA	60 mm	80 mm	100 mm	120 mm	140 mm	200 mm
FINITURA	OLV	OLV	OLV	OLV	OLV	OLV
IMBALLO	25	25	25	25	25	25

FINITURA	CR	CR	CR	CR	CR	CR
----------	----	----	----	----	----	----

art. 6.0012

catenaccio fermapersiane multiplo

MISURA	da 60 a 140 mm
FINITURA	OLV
IMBALLO	20



art. 6.0170

gancio fermapersiane snodato

	6.0170.05	6.0170.07	6.0170.10	6.0170.12
MISURA	50 mm	75 mm	100 mm	125 mm
FINITURA	OLV	OLV	OLV	OLV
IMBALLO	20	20	20	20

	6.0170.15	6.0170.20	6.0170.25	6.0170.30
MISURA	150 mm	200 mm	250 mm	300 mm
FINITURA	OLV	OLV	OLV	OLV
IMBALLO	20	20	20	20



art. 6.0180

gancio fermapersiane snodato

	6.0180.10	6.0180.15
MISURA	100 mm	150 mm
FINITURA	FERRO NR	FERRO NR
IMBALLO	20	20



art. 6.0200

bloccapersiane a incasso 220x50x22 mm

art. 6.0210

bloccapersiane a vite 150x50x22 mm

FINITURA	OL
IMBALLO	12



art. 6.0250

omino fermapersiane regolabile da 20 a 65 mm

FINITURA	OL
IMBALLO	15

CATENELLE di SICUREZZA



art. 6.0090

gancio Roma

FINITURA	OLV	BR
IMBALLO	12	12



art. 7.4080

catenella di sicurezza Napoli leggera 150 mm

FINITURA	OL	BR
IMBALLO	50	50

art. 7.4081

catenella di sicurezza Napoli pesante 180 mm

FINITURA	OL	BR
IMBALLO	50	50



art. 7.4085

catenella di sicurezza pesante
filo ottone ø 2,7 mm

FINITURA	OLV	ANT
IMBALLO	25	25

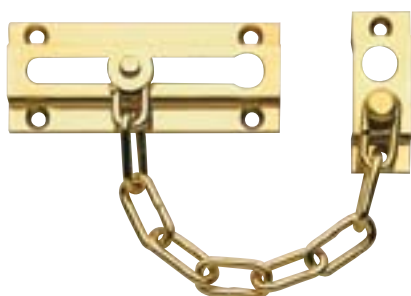

art. 7.4090

catenella di sicurezza

FINITURA	OLV	BR	CR
IMBALLO	20	20	20



art. 7.4095

catenella di sicurezza Robur

FINITURA	OLV
IMBALLO	10



art. 5.4610

cerniera fresata piena

MISURA	30x25 mm	30x30 mm	35x30 mm	35x35 mm	40x30 mm	40x35 mm
FINITURA	SAT	SAT	SAT	SAT	SAT	SAT
IMBALLO	24	24	24	24	24	24

MISURA	40x40 mm	50x40 mm	50x50 mm	60x50 mm	70x55 mm	80x60 mm
FINITURA	SAT	SAT	SAT	SAT	SAT	SAT
IMBALLO	24	24	24	24	24	24



art. 5.4611

cerniera mezza zancata

MISURA	35x35 mm	40x35 mm	40x40 mm
FINITURA	SAT	SAT	SAT
IMBALLO	24	24	24

MISURA	50x40 mm	50x50 mm	60x50 mm
FINITURA	SAT	SAT	SAT
IMBALLO	24	24	24

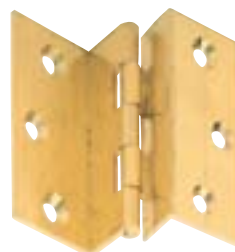

art. 5.4712

cerniera doppia zancata

MISURA	35x35 mm	40x35 mm	40x40 mm
FINITURA	SAT	SAT	SAT
IMBALLO	24	24	24

MISURA	50x40 mm	50x50 mm	60x50 mm	70x55 mm
FINITURA	SAT	SAT	SAT	SAT
IMBALLO	24	24	24	24

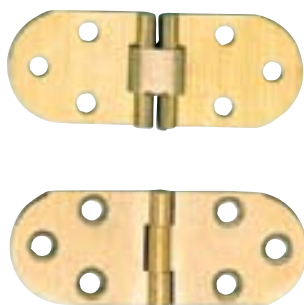

art. 5.4600

cerniera Biscotto con fermo 30x80 mm

FINITURA	OTT. SAT
IMBALLO	24

art. 5.4601

cerniera Biscotto senza fermo 30x80 mm

FINITURA	OTT. SAT
IMBALLO	24



art. 5.4760 DX

art. 5.4761 SX

cerniera piana con piramide canotto liscio

MISURA	40x40 mm	50x40 mm	60x40 mm
FINITURA	OL	OL	OL
IMBALLO	24	24	24



art. 5.4770 DX

art. 5.4771 SX

cerniera rigata piana con piramide

MISURA	40x40 mm	50x40 mm	60x40 mm
FINITURA	OL	OL	OL
IMBALLO	24	24	24

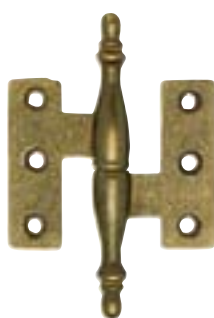

art. 5.4500 DX

art. 5.4501 SX

cerniera Barocco piccola
60x55 mm

FINITURA	BR
IMBALLO	24

art. 5.4510 DX

art. 5.4511 SX

cerniera Barocco grande
90x60 mm

FINITURA	BR
IMBALLO	24



art. 5.4520 DX

art. 5.4521 SX

cerniera Barocco zancata
60x55 mm

FINITURA	BR
IMBALLO	24

art. 5.4530 DX

art. 5.4531 SX

cerniera Barocco zancata
90x60 mm

FINITURA	BR
IMBALLO	24



art. 5.4715 DX

art. 5.4716 SX

cerniera Maschietto

MISURA	190x100 mm	190x120 mm
FINITURA	OL	OL
IMBALLO	12	12



art. 5.4720 DX

art. 5.4721 SX

cerniera Poumelle

MISURA	85x50 mm	100x55 mm	100x60 mm
FINITURA	OL	OL	OL
IMBALLO	12	12	12

MISURA	120x60 mm	120x75 mm	140x70 mm
FINITURA	OL	OL	OL
IMBALLO	12	12	12



art. 5.4730 DX

art. 5.4731 SX

cerniera a libro

MISURA	100x65 mm	120x70 mm	140x75 mm
FINITURA	OL	OL	OL
IMBALLO	12	12	12



art. 5.4735 DX

art. 5.4736 SX

cerniera a libro zancata

MISURA	10x65 mm	120x65 mm
FINITURA	OL	OL
IMBALLO	12	12



art. 5.4740 DX

art. 5.4741 SX

cerniera Grossezza

MISURA	100 mm	120 mm	140 mm
FINITURA	OL	OL	OL
IMBALLO	12	12	12



art. 5.4750 DX

art. 5.4751 SX

cerniera per ascensore

MISURA	65x80
FINITURA	OL
IMBALLO	12



art. 2.2400

chiave

FINITURA	OLV	ANT	CR
IMBALLO	24	24	24

FINITURA	CRS	ORO ANT	ARG ANT
----------	-----	---------	---------



art. 2.2401

chiave

FINITURA	OLV
IMBALLO	24



art. 2.2402

coprichiave scanellato

FINITURA	OLV
IMBALLO	24



art. 2.2403

coprichiave tondo

FINITURA	OLV
IMBALLO	24



art. 2.2420

chiave

FINITURA	OLV	ANT	CR	CRS
IMBALLO	24	24	24	24



art. 2.2430

chiave

FINITURA	OLV
IMBALLO	24

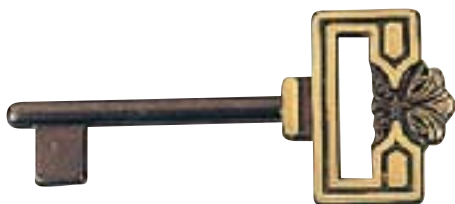

art. 2.2440

chiave

FINITURA	BR
IMBALLO	24



art. 2.2460

chiave

FINITURA	OLV	ANT	CR	CRS
IMBALLO	24	24	24	24



art. 2.2470

chiave tonda liscia 90x28 mm

FINITURA	OLV	BR	CR	CRS
IMBALLO	24	24	24	24



art. 2.2475

chiave tonda rigata 90x28 mm

FINITURA	OLV	BR	CR	CRS
IMBALLO	24	24	24	24



art. 2.2480

chiave maschio 100 mm
con mappa 13x12 mm

FINITURA	FERRO NR
IMBALLO	50

PORTABITI e GANCI



art. 3.2400

portabito Big
280x140x120 mm

FINITURA	OLV	OGR
IMBALLO	2	2



art. 3.2204

portabito Urano
ø 60 mm

FINITURA	OLV
IMBALLO	4



art. 3.2214

portabito Nettuno
ø 60 mm

FINITURA	OLV
IMBALLO	4



art. 3.2234

portabito Plutone
ø 60 mm

FINITURA	OLV
IMBALLO	4



art. 3.2244

portabito Mercurio
ø 60 mm

FINITURA	OLV
IMBALLO	4



art. 3.2320

portabito Classico

FINITURA	Z. OTT	Z. BR
IMBALLO	12	12



art. 3.2330

portabito Ovale

FINITURA	Z. OTT	Z. BR
IMBALLO	12	12



art. 3.2340

portabito Tondo

FINITURA	Z. OTT	Z. BR
IMBALLO	12	12



art. 3.2350

gancio Marina

FINITURA	OLV	CR
IMBALLO	30	30



art. 3.2360

portabito Splendid
125x70 mm

FINITURA	OLV
IMBALLO	6



art. 3.2365

gancio Splendid
43x70 mm

FINITURA	OLV
IMBALLO	24



art. 3.2370

portabito Victorian
130x60 mm

FINITURA	OLV
IMBALLO	6

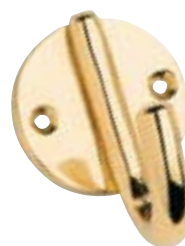

art. 3.2375

gancio Victorian
70x60 mm

FINITURA	OLV
IMBALLO	6



art. 3.2380

portabito multiplo
145 mm

FINITURA	OLV
IMBALLO	10



art. 3.2385

portabito Rustico
125x70 mm

FINITURA	FERRO NR
IMBALLO	12



art. 3.2355

gancio Rustico
40x40 mm

FINITURA	FERRO NR
IMBALLO	24



art. 3.2356

gancio Rustico 2 posti
40x100 mm

FINITURA	FERRO NR
IMBALLO	10



art. 3.2357

gancio Rustico 3 posti
40x150 mm

FINITURA	FERRO NR
IMBALLO	10



art. 3.2390

portabito Regency
130x60 mm

FINITURA	OLV
IMBALLO	6



art. 3.2395

portabito Regency
70x60 mm

FINITURA	OLV
IMBALLO	6



art. 3.2440

portabito per armadio
ø 25 mm

FINITURA	OLV	OGR
IMBALLO	20	20



art. 3.2450

Base per attaccapanni

FINITURA	OLV	ANT	CR	CRS
IMBALLO	24	24	24	24

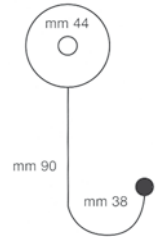

art. 3.2455

portabito Lyl
39x120 mm

FINITURA	OLV
IMBALLO	12



art. 3.2456

portabito Lyl
39x54 mm

FINITURA	OLV
IMBALLO	24



art. 3.2460

portabito Triplex
85x40x140 mm

FINITURA	OLV	ANT	CR	CRS
IMBALLO	10	10	10	10



art. 3.2491

portabito a 1 posto

FINITURA	Z. ORO	Z. BN	Z. CRS
IMBALLO	12	12	12

art. 3.2492

portabito a 2 posti

FINITURA	Z. ORO	Z. BN	Z. CRS
IMBALLO	6	6	6



art. 3.2493

portabito a 3 posti

FINITURA	Z. ORO	Z. BN	Z. CRS
IMBALLO	4	4	4



art. 3.2496

portabito singolo
108x145 mm

FINITURA	Z. ORO	Z. BZ	Z. NIK
IMBALLO	12	12	12



art. 3.7260

portabito Star

FINITURA	Z. LUC	Z. BR	Z. CR	Z. CRS	Z. BN
IMBALLO	12	12	12	12	12

art. 3.7210

portabito Ely
45x145x55 mm

FINITURA	OLV	CR	CRS
IMBALLO	10	10	10



art. 3.7200

gancio Ely
45x55x55 mm

FINITURA	OLV	CR	CRS
IMBALLO	20	20	20



art. 3.7220

gancio doppio Ely
65x60x40 mm

FINITURA	OLV	CR	CRS
IMBALLO	20	20	20



art. 3.7230

gancio Farfalla
60x38x33

FINITURA	OLV	OGR	CR	CRS
IMBALLO	20	20	20	20



art. 3.7240

gancio Spirale
50x95x30 mm

FINITURA	OLV	OGR	CR	CRS	NR
IMBALLO	20	20	20	20	20



art. 3.7250

gancio Gun
40x68x42 mm

FINITURA	OLV	CR	CRS
IMBALLO	20	20	20

**art. 6.1014**gancio da cucina doppio
40x19x50 mm

FINITURA	OLV	CR
IMBALLO	100	100

**art. 6.1016**

gancio da cucina

	6.1016	6.1017	6.1018
MISURA	46x38 mm	40x30 mm	34x22 mm
FINITURA	OLV	OLV	OLV
IMBALLO	50	100	100

FINITURA	CR	CR	CR
----------	----	----	----

**art. 6.1020**gancio doppio Big
42x53x30 mm

FINITURA	OLV	CR	CRS
IMBALLO	20	20	20

**art. 6.1033**

gancio Luna

	6.1031	6.1032	6.1033
MISURA	32x20x6 mm	29x16x6 mm	26x14x6 mm
FINITURA	OL	OL	OL
IMBALLO	100	100	100

**art. 6.1059**gancio per tendaggi leggero
40x15 mm

FINITURA	OLV
IMBALLO	100

**art. 6.1060**gancio per tendaggi leggero
35x14 mm

FINITURA	OLV
IMBALLO	100

**art. 6.1062**gancio per tendaggi leggero
30x11 mm

FINITURA	OLV
IMBALLO	100

**art. 6.1063**gancio per tendaggi leggero
24x9 mm

FINITURA	OLV
IMBALLO	100

**art. 6.1064**

gancio a cuore

	6.1064	6.1065	6.1066
MISURA	40x20x6 mm	35x16x6 mm	30x14x6 mm
FINITURA	OL	OL	OL
IMBALLO	100	100	100

**art. 6.1070**gancio Palma
70x30x30 mm

FINITURA	OLV
IMBALLO	50

**art. 6.1071**gancio Palma
55x30x30 mm

FINITURA	OLV
IMBALLO	50

**art. 6.1072**gancio Palma
45x27x20 mm

FINITURA	OLV
IMBALLO	50

**art. 6.1079**

gancio da cucina

	6.1079	6.1080	6.1081
MISURA	ø 11 mm	ø 16 mm	ø 18 mm
FINITURA	OLV	OLV	OLV
IMBALLO	50	100	100

FINITURA	BR	BR	BR
----------	----	----	----

FINITURA	CR	CR	CR
----------	----	----	----

FINITURA	CRS	CRS	CRS
----------	-----	-----	-----

**art. 6.1090**

gancio Impero

FINITURA	OLV
IMBALLO	50

**art. 6.1102**

gancio per tendaggi Barocco

	6.1102	6.1103	6.1104
MISURA	50x45 mm	30x30 mm	22x22 mm
FINITURA	OL	OL	OL
IMBALLO	50	100	100

**art. 6.1120**gancio
75 mm

FINITURA	OLV	OGR	CR
IMBALLO	30	30	30



art. 6.1131

gancio Fiorentino
55x25x20 mm

FINITURA	OLV
IMBALLO	100



art. 6.1132

gancio Fiorentino
45x27x17 mm

FINITURA	OLV
IMBALLO	100



art. 6.1133

gancio Fiorentino
33x16x6 mm

FINITURA	OLV
IMBALLO	100



art. 6.1145

gancio Tudor

FINITURA	ORO ANT
IMBALLO	12



art. 6.1146

gancio per tendaggi con rosetta Barocco
45x90x65 mm

FINITURA	OL
IMBALLO	25



art. 6.1147

gancio per tendaggi con rosetta liscia
45x90x65 mm

FINITURA	OL
IMBALLO	25



art. 6.1149

gancio per tendaggi pesante
54x45x26 mm

FINITURA	OLV	BR	NR	CR
IMBALLO	30	30	30	30



art. 6.1150

gancio per tendaggi pesante
47x36x25 mm

FINITURA	OLV	BR	NR	CR
IMBALLO	30	30	30	30



art. 6.1151

gancio per tendaggi pesante
38x33x20 mm

FINITURA	OLV	BR	NR	CR
IMBALLO	30	30	30	30



art. 6.1152

gancio per tendaggi pesante
33x26x15 mm

FINITURA	OLV	BR	NR	CR
IMBALLO	30	30	30	30



art. 6.1154

gancio Barocco

6.1154 6.1155

MISURA	34x20x7 mm	16x15x5 mm
FINITURA	OL	OL
IMBALLO	100	100



art. 6.1213

gancio Fiocchetto

FINITURA	OLV
IMBALLO	50



art. 6.1220

gancio Cheri
38x12x17 mm

FINITURA	OLV
IMBALLO	100



art. 6.1400

placca rettangolare 5 ganci
250x45 mm

FINITURA	OLV
IMBALLO	4



art. 6.1410

placca tonda 5 ganci
225x40 mm

FINITURA	OLV	CR
IMBALLO	4	4

serie EMBRASSE



art. 6.1035

embrasse Indy
30x42x45 mm

FINITURA	OLV
IMBALLO	30



art. 6.1040

embrasse Corona
30x90x30 mm

FINITURA	OLV
IMBALLO	30



art. 6.1041

embrasse Corona piccolo
20x66x25 mm

FINITURA	OLV
IMBALLO	30



art. 6.1045

embrasse Flow
32x32x24 mm

FINITURA	OLV
IMBALLO	30



art. 6.1050

embrasse Fiore grande
48x96x30 mm

FINITURA	OLV
IMBALLO	30



art. 6.1051

embrasse Fiore piccolo
32x62x24 mm

FINITURA	OLV
IMBALLO	30



art. 6.1160

embrasse Sole
80x40x30 mm

FINITURA	OLV
IMBALLO	30



art. 6.1170

embrasse Luna
80x40x30 mm

FINITURA	OLV
IMBALLO	30



art. 6.1180

embrasse Conchiglia
65x40x25 mm

FINITURA	OLV
IMBALLO	30



art. 6.1190

embrasse Ancora
115x55x28 mm

FINITURA	OLV
IMBALLO	30



art. 6.1200

embrasse Edelweiss
40x20x16 mm

FINITURA	OLV
IMBALLO	100



art. 6.1210

embrasse Fiocco Mini
46x29x23 mm

FINITURA	OLV
IMBALLO	50



art. 6.1211

embrasse Fiocco Medio
66x37x27 mm

FINITURA	OLV
IMBALLO	30



art. 6.1212

embrasse Fiocco Big
80x95x40 mm

FINITURA	OLV
IMBALLO	6



art. 6.1230

embrasse Pigna
105x32x30 mm

FINITURA	OLV
IMBALLO	30



art. 6.1240

embrasse Cavallo
110x45x25 mm

FINITURA	OLV
IMBALLO	30



art. 6.1250

embrasse Shanghai
105x32x30 mm

FINITURA	OLV
IMBALLO	30



art. 6.1261

embrasse Serpente
35x35 mm

FINITURA	OLV
IMBALLO	30



art. 6.1270

embrasse Ottagonale
35x50 mm

FINITURA	OLV
IMBALLO	30



art. 6.1340

embrasse Rosa
95x55x35 mm

FINITURA	OLV
IMBALLO	30



art. 6.1350

embrasse Girasole
85x50x23 mm

FINITURA	OLV
IMBALLO	30



art. 6.1360

embrasse Cigno

FINITURA	OLV	CR
IMBALLO	30	30



art. 6.1370

embrasse nero con terminali
64x28 ø10 mm

FINITURA	OLV	BR	CR	CRS
IMBALLO	30	30	30	30



art. 6.1380

embrasse Lily
85x45x27 mm

FINITURA	OLV
IMBALLO	30



art. 6.1390

embrasse Giglio con sfera
55x25x20 mm

FINITURA	OLV
IMBALLO	30



art. 7.4800

embrasse liscio
 ø 65 - 110 mm

FINITURA	OLV
IMBALLO	6



art. 7.4805

embrasse liscio
 ø 60 - 90 mm

FINITURA	OLV
IMBALLO	10



art. 7.4810

embrasse Style
 ø 78 - 110 mm

FINITURA	OLV
IMBALLO	50



art. 7.4815

embrasse Style
 ø 50 - 90 mm

FINITURA	OLV
IMBALLO	30



art. 7.4820

embrasse Liberty

	7.4820.03	7.4820.05	7.4820.08	7.4820.II	7.4820.II
MISURA	30x30 mm	50x35 mm	80x40 mm	110x45 mm	150x50 mm
FINITURA	OLV	OLV	OLV	OLV	OLV
IMBALLO	30	30	30	30	30



art. 7.4830

embrasse Victorian
 ø 60 - 110 mm

FINITURA	OLV
IMBALLO	10



art. 7.4840

embrasse Georgian
 ø 60 - 110 mm

FINITURA	OLV
IMBALLO	10



art. 7.4850

embrasse Fiocco
110 mm

FINITURA	OLV
IMBALLO	10



art. 7.4880

embrasse Linea

	7.4880.03	7.4880.05	7.4880.08	7.4880.11	7.4880.15
MISURA	30x30 mm	50x35 mm	80x40 mm	110x45 mm	150x50 mm
FINITURA	OLV	OLV	OLV	OLV	OLV
IMBALLO	30	30	30	30	30



art. 7.4890

embrasse Ottagonale

	7.4890.10	7.4890.15	7.4890.20	7.4890.25
MISURA	100 mm	150 mm	200 mm	250 mm
FINITURA	OLV	OLV	OLV	OLV
IMBALLO	25	25	25	25



art. 7.4900

embrasse Flowers
ø 55 - 90 mm

FINITURA	OLV
IMBALLO	10



art. 7.4910

embrasse Cupola
80x50 mm

FINITURA	OLV
IMBALLO	10



art. 7.4920

embrasse Elica
ø 80 - 100 mm

FINITURA	OLV
IMBALLO	10



art. 7.4930

embrasse Tudor
ø 75 - 80 mm

FINITURA	ORO ANT
IMBALLO	12



art. 7.4940

embrasse Stella
ø 70 - 80 mm

FINITURA	ORO ANT
IMBALLO	12



art. 6.5410

maniglia senza foro chiave
96x46 mm

FINITURA	ANT
IMBALLO	25



art. 6.5411

maniglia con foro chiave
96x46 mm

FINITURA	ANT
IMBALLO	25



art. 6.5420

maniglia
35x59 mm

FINITURA	ANT
IMBALLO	25



art. 6.5790

maniglia

	6.5790	6.5791
MISURA	167x45 mm	135x32 mm
FINITURA	ANT	ANT
IMBALLO	25	25



art. 6.5800

maniglia ovale a incasso
112x31 mm - int. 90x120

FINITURA	ANT
IMBALLO	25



art. 6.5810

maniglia ovale a incasso
78x25 mm - int. 58x77

FINITURA	ANT
IMBALLO	25



art. 6.5820

maniglia rettangolare a incasso
39x42 mm - int. ø 24 mm

FINITURA	ANT
IMBALLO	25



art. 6.5835

maniglia floreale
115x35 mm - int. 64 mm

FINITURA	ANT
IMBALLO	25



art. 6.5840

maniglia portanome
int. 55x23 mm

FINITURA	ANT
IMBALLO	25



art. 6.5850

maniglia

	6.5850	6.5851	6.5852	6.5853
MISURA	ø 55 mm	ø 47 mm	ø 37 mm	ø 22 mm
FINITURA	ANT	ANT	ANT	ANT
IMBALLO	25	25	25	25



art. 6.5860

maniglia

	6.5860	6.5861
MISURA	96 mm	64 mm
FINITURA	ANT	ANT
IMBALLO	25	25



art. 6.5870

maniglia
86x50 mm - int. 64 mm

FINITURA	ANT
IMBALLO	25



art. 6.5880

maniglia

	6.5880	6.5881
MISURA	105x45 mm - int. 64 mm	76x33 mm - int. 32 mm
FINITURA	ANT	ANT
IMBALLO	25	25



art. 6.5890

maniglia

	6.5890	6.5891	6.5892
MISURA	ø 70 mm	ø 57 mm	ø 43 mm
FINITURA	ANT	ANT	ANT
IMBALLO	25	25	25



art. 6.5900

maniglia

	6.5900	6.5901
MISURA	118x42 mm - int. 96 mm	82x32 mm - int. 64 mm
FINITURA	ANT	ANT
IMBALLO	25	25



art. 6.5910

maniglia

	6.5910	6.5911
MISURA	118x52 mm - int. 96 mm	82x40 mm - int. 64 mm
FINITURA	ANT	ANT
IMBALLO	25	25



art. 6.5920

maniglia

	6.5920	6.5921
MISURA	121x47 mm - int. 96 mm	83x33 mm - int. 64 mm
FINITURA	ANT	ANT
IMBALLO	25	25



art. 6.5950

maniglia
40x49 mm

FINITURA	ANT
IMBALLO	25



art. 6.5960

maniglia
int. 96 mm

FINITURA	ANT
IMBALLO	25



art. 6.5970

maniglia

	6.5970	6.5971
MISURA	96 mm	64 mm
FINITURA	ANT	ANT
IMBALLO	25	25



art. 6.5980

maniglia
int. 96 mm

FINITURA	ANT
IMBALLO	25



art. 6.5990

maniglia

	6.5990	6.5991
MISURA	82x43 mm	64x34 mm
FINITURA	ANT	ANT
IMBALLO	25	25



art. 6.6000

maniglia senza foro chiave
94x44 mm

FINITURA	ANT
IMBALLO	25



art. 6.6001

maniglia con foro chiave
94x44 mm

FINITURA	ANT
IMBALLO	25



art. 6.6010

maniglia
85x34 mm

FINITURA	ANT
IMBALLO	25



art. 6.6020

maniglia

	6.6020	6.6021	6.6022
MISURA	135x45 mm	119x39 mm	105x33 mm
FINITURA	ANT	ANT	ANT
IMBALLO	25	25	25



art. 6.6030

maniglia

	6.6030	6.6031
MISURA	124x52 mm	84x36 mm
FINITURA	ANT	ANT
IMBALLO	25	25



art. 6.6040

maniglia

	6.6040	6.6041
MISURA	ø 52 mm	ø 42 mm
FINITURA	ANT	ANT
IMBALLO	25	25



art. 6.6050

maniglia

	6.6050	6.6051	6.6052
MISURA	96x57 mm	59x50 mm	49x40 mm
FINITURA	ANT	ANT	ANT
IMBALLO	25	25	25



art. 6.6060

maniglia senza foro chiave
34x96 mm

FINITURA	ANT
IMBALLO	25



art. 6.6061

maniglia con foro chiave
34x96 mm

FINITURA	ANT
IMBALLO	25



art. 6.6070

maniglia
34X48 mm

FINITURA	ANT
IMBALLO	25



art. 6.6080

maniglia
50X52 mm

FINITURA	ANT
IMBALLO	25



art. 6.6090

maniglia
34X55 mm

FINITURA	ANT
IMBALLO	25



art. 6.6100

maniglia

	6.6100	6.6101
MISURA	68X60 mm	50X48 mm
FINITURA	ANT	ANT
IMBALLO	25	25



art. 6.6110

maniglia

	6.6110	6.6111
MISURA	68X60 mm	50X45 mm
FINITURA	ANT	ANT
IMBALLO	25	25



art. 6.6120

maniglia

	6.6120	6.6121
MISURA	60X52 mm	50X46 mm
FINITURA	ANT	ANT
IMBALLO	25	25



art. 6.6130

maniglia

	6.6130	6.6131
MISURA	ø 47 mm	ø 37 mm
FINITURA	ANT	ANT
IMBALLO	25	25



art. 6.6140

maniglia

	6.6140	6.6141
MISURA	ø 51 mm	ø 42 mm
FINITURA	ANT	ANT
IMBALLO	25	25



art. 6.6190

bocchetta floreale orizzontale
115x35 mm

FINITURA	ANT
IMBALLO	25



art. 6.6195

bocchetta floreale verticale
35x115 mm

FINITURA	ANT
IMBALLO	25



art. 6.6200

bocchetta
30x50 mm

FINITURA	ANT	OLN
IMBALLO	25	25



art. 6.6205

bocchetta
34x46 mm

FINITURA	ANT
IMBALLO	25



art. 6.6210

bocchetta
50x30 mm

FINITURA	ANT	OLN
IMBALLO	25	25



art. 6.6220

bocchetta
62x34 mm

FINITURA	ANT
IMBALLO	25



art. 6.6230

bocchetta
34x62 mm

FINITURA	ANT
IMBALLO	25



art. 6.6240

bocchetta
15x98 mm

FINITURA	ANT
IMBALLO	25



art. 6.6250

bocchetta
18X36 mm

FINITURA	ANT	ONLV
IMBALLO	25	25



art. 6.6260

bocchetta
24X46 mm

FINITURA	ANT
IMBALLO	25



art. 6.6270

bocchetta
ø 32 mm

FINITURA	ANT
IMBALLO	25



art. 6.6280

bocchetta

	6.6280	6.6281
MISURA	ø 53 mm	ø 41 mm
FINITURA	ANT	ANT
IMBALLO	25	25



art. 6.6290

bocchetta
32x35 mm

FINITURA	ANT
IMBALLO	25



art. 6.6295

bocchetta orizzontale
101x24 mm

FINITURA	ANT
IMBALLO	25



art. 6.6296

bocchetta verticale
24x101 mm

FINITURA	ANT
IMBALLO	25



art. 6.6300

bocchetta verticale
32x96 mm

FINITURA	ANT
IMBALLO	25



art. 6.6310

bocchetta orizzontale
96x32 mm

FINITURA	ANT
IMBALLO	25



art. 6.6320

bocchetta
49x40 mm

FINITURA	ANT
IMBALLO	25



art. 6.6325

bocchetta
s 49 mm

FINITURA	ANT
IMBALLO	25



art. 6.6330

bocchetta
23x43 mm

FINITURA	ANT
IMBALLO	25



art. 6.6340

bocchetta
22x56 mm

FINITURA	ANT
IMBALLO	25



art. 6.6350

bocchetta
36x57 mm

FINITURA	ANT
IMBALLO	25



art. 6.6360

bocchetta
59x62 mm

FINITURA	ANT
IMBALLO	25



art. 6.6370

bocchetta
25x35 mm

FINITURA	ANT
IMBALLO	25



art. 6.6380

bocchetta
35x25 mm

FINITURA	ANT
IMBALLO	25



art. 6.6385

bocchetta
19x52 mm

FINITURA	ANT
IMBALLO	25



art. 6.6390

bocchetta
70x45 mm

FINITURA	ANT
IMBALLO	25



art. 6.6395

bocchetta
96x33 mm

FINITURA	ANT
IMBALLO	25



art. 3.8610

pomolino

MISURA	ø 22 mm	ø 27 mm	ø 32 mm
FINITURA	ANT	ANT	ANT
IMBALLO	25	25	25



art. 3.8615

pomolino

MISURA	ø 20 mm	ø 25 mm	ø 30 mm
FINITURA	ANT	ANT	ANT
IMBALLO	25	25	25



art. 3.8620

pomolino

MISURA	ø 30 mm
FINITURA	ANT
IMBALLO	25



art. 3.8625

pomolino

MISURA	ø 20 mm	ø 25 mm	ø 30 mm
FINITURA	ANT	ANT	ANT
IMBALLO	25	25	25



art. 3.8630

pomolino

MISURA	ø 24 mm	ø 29 mm	ø 34 mm
FINITURA	ANT	ANT	ANT
IMBALLO	25	25	25



art. 3.8635

pomolino

MISURA	ø 20 mm	ø 25 mm	ø 30 mm
FINITURA	ANT	ANT	ANT
IMBALLO	25	25	25



art. 3.8640

pomolino

MISURA	ø 24 mm	ø 29 mm	ø 34 mm
FINITURA	ANT	ANT	ANT
IMBALLO	25	25	25



art. 3.8645

pomolino

MISURA	ø 20 mm	ø 25 mm	ø 30 mm
FINITURA	ANT	ANT	ANT
IMBALLO	25	25	25



art. 3.8650

pomolino

MISURA	54x14 mm
FINITURA	ANT
IMBALLO	25



art. 3.8655

pomolino

MISURA	ø 16 mm	ø 24 mm	ø 27 mm
FINITURA	ANT	ANT	ANT
IMBALLO	25	25	25



art. 3.8660

pomolino

MISURA	ø 25 mm	ø 35 mm
FINITURA	ZAMA ANT	ZAMA ANT
IMBALLO	25	25



art. 3.8665

pomolino

MISURA	ø 25 mm	ø 30 mm
FINITURA	ANT	ANT
IMBALLO	25	25



art. 3.8670

pomolino

MISURA	ø 20 mm	ø 30 mm
FINITURA	ZAMA ANT	ZAMA ANT
IMBALLO	25	25



art. 3.8675

pomolino

MISURA	ø 25 mm	ø 35 mm
FINITURA	ANT	ANT
IMBALLO	25	25



art. 3.8680

pomolino

MISURA	ø 25 mm	ø 30 mm
FINITURA	ANT	ANT
IMBALLO	25	25



art. 6.6145

fregio
180x45 mm

FINITURA	ANT
IMBALLO	25



art. 6.6155

fregio
155x52 mm

FINITURA	ANT
IMBALLO	25



art. 6.6165

fregio
165x48 mm

FINITURA	ANT
IMBALLO	25



art. 6.6175

fregio
147x49 mm

FINITURA	ANT
IMBALLO	25



art. 6.6185

fregio
96x55 mm

FINITURA	ANT
IMBALLO	25



art. 6.6186

fregio
38x62 mm

FINITURA	ANT
IMBALLO	25



art. 6.6187

fregio
25x108 mm

FINITURA	ANT
IMBALLO	25



art. 6.6188

fregio

	6.6188	6.6189
MISURA	18x73 mm	23x58 mm
FINITURA	ANT	ANT
IMBALLO	25	25



art. 6.6400

chiave

	6.6400	6.6401
MISURA	ø 6x40 mm	ø 6x32 mm
FINITURA	ANT	ANT
IMBALLO	25	25



art. 6.6410

chiave

	6.6410
MISURA	ø 6x32 mm
FINITURA	ANT
IMBALLO	25



art. 6.6420

chiave

	6.6420	6.6420	6.6421	6.6422
MISURA	ø 6x40 mm	ø 6x40 mm	ø 6x32 mm	mappa grande
FINITURA	OL NATURALE	ANT	ANT	ANT
IMBALLO	25	25	25	25



art. 6.6430

chiave

	6.6430	6.6431
MISURA	ø 6x43 mm	ø 6x32 mm
FINITURA	ANT	ANT
IMBALLO	25	25



art. 6.6440

chiave

	6.6440	6.6441
MISURA	ø 6x40 mm	ø 6x32 mm
FINITURA	ANT	ANT
IMBALLO	25	25



art. 6.6460

chiave

	6.6460	6.6461
MISURA	ø 6x40 mm	ø 6x32 mm
FINITURA	ANT	ANT
IMBALLO	25	25



art. 6.6470

chiave

	6.6470	6.6470	6.6471
MISURA	ø 6x40 mm	ø 6x40 mm	ø 6x32 mm
FINITURA	OL NATURALE	ANT	ANT
IMBALLO	25	25	25



art. 2.9060

rosetta decorativa tonda

MISURA	ø 50 mm	ø 43 mm	ø 35 mm	ø 28 mm	ø 23 mm
FINITURA	ANT	ANT	ANT	ANT	ANT
IMBALLO	25	25	25	25	25



art. 2.9065

rosetta decorativa quadra

MISURA	38x38 mm	30x30 mm
FINITURA	ANT	ANT
IMBALLO	25	25



art. 6.5400

passamano
ø 30 mm

FINITURA	ANT
IMBALLO	12



art. 6.6450

pomolo
44x36 mm

FINITURA	ANT
IMBALLO	25



art. 6.6451

chiavistello
44x88 mm

FINITURA	ANT
IMBALLO	25

serie SET PER TENDE



art. 6.4060

coppia astina Bris-bris

	6.4060	6.4080	6.4100
MISURA	40/60 mm	60/80 mm	80/100 mm
FINITURA	OLV	OLV	OLV
IMBALLO	50	100	100

FINITURA	CR	-	-
----------	----	---	---



POSIZIONARE



FISSARE



RISULTATO FINALE



art. 6.1680

gancetti invisibili per tendine
si fissano senza colla e senza fori
su tutti i tipi di finestra e sono riposizionabili
disponibili in blister da 4 pezzi

FINITURA	BR	BN	NIK	OTT
IMBALLO	20	20	20	20

art. 6.4450

set completo per tende composto da:
2 finali - 3 mensole - 20 anelli \varnothing 32 mm - 1 bastone telescopico estensibile da 125 mm a max 225 mm

ogni BOX contiene:
8 bastoni con finale art. 6.4350 - 8 bastoni con finale art. 6.4380

FINITURA	FERRO NR
IMBALLO	16 SET x BOX

BASTONI PER TENDE



art. 6.4500

bastone per tende
ø 19 mm

MISURA	120 mm	150 mm	180 mm
FINITURA	FERRO NR	FERRO NR	FERRO NR
IMBALLO	25	25	25



art. 6.4500.180

bastone per tende
ø 19 mm

MISURA	180 mm
FINITURA	FERRO NR ORO
IMBALLO	20



art. 6.4501

adattatore per prolunga bastone nero

ANELLI PER TENDE



art. 6.4200

anelli per bastoni reggitende

6.4200.45 6.4200.60 6.4200.72

MISURA	ø est. 45 mm	ø est. 60 mm	ø est. 72 mm
FINITURA	OLV	OLV	OLV
IMBALLO	140	140	140



art. 6.4250

anelli per bastoni reggitende

6.4250.25 6.4250.32

MISURA	ø est. 25 mm	ø est. 32 mm
FINITURA	FERRO NR	FERRO NR
IMBALLO	50	50



art. 6.4250.320

anelli per bastoni reggitende
ø est. 32 mm

FINITURA	FERRO NR ORO
IMBALLO	50

FINALI PER TENDE



art. 6.4300

finale per bastone
ø 19 mm

FINITURA	FERRO NR	FERRO NR ORO
IMBALLO	6	6



art. 6.4310

finale per bastone
ø 19 mm

FINITURA	NR
IMBALLO	6



art. 6.4330

finale per bastone
ø 19 mm

FINITURA	NR
IMBALLO	6



art. 6.4340

finale per bastone
ø 19 mm

FINITURA	NR
IMBALLO	6



art. 6.4350

finale per bastone
ø 19 mm

FINITURA	NR	NR ORO
IMBALLO	6	6



art. 6.4360

finale per bastone
ø 19 mm

FINITURA	NR
IMBALLO	6



art. 6.4370

finale per bastone
ø 19 mm

FINITURA	NR
IMBALLO	6



art. 6.4380

finale per bastone
ø 19 mm

FINITURA	FERRO NR	FERRO NR ORO
IMBALLO	6	6



art. 6.4390

finale per bastone
ø 19 mm

FINITURA	NR
IMBALLO	6



art. 7.4700

finale Ghianda piccola per tenda
ø 33 mm

FINITURA	OLV
IMBALLO	12



art. 7.4710

finale Ghianda grande per tenda
45x70 mm

FINITURA	OLV
IMBALLO	6



art. 7.4720

finale Pigna per tenda
93x65 mm

FINITURA	OLV
IMBALLO	2



art. 7.4725

finale Pigna per tenda
75x50 mm

FINITURA	OLV
IMBALLO	2



art. 7.4730

finale Roma per tenda
85x80 mm

FINITURA	OLV
IMBALLO	2



art. 7.4735

finale Roma per tenda
78x58 mm

FINITURA	OLV
IMBALLO	2



art. 7.4740

finale Girella per tenda
ø 55 mm

FINITURA	OLV
IMBALLO	2



art. 7.4745

finale Margherita per tenda
ø 50 mm

FINITURA	OLV
IMBALLO	2



art. 7.4750

finale Ovale rigata per tenda

	7.4750	7.4751
MISURA	85x45 mm	95x55 mm
FINITURA	OLV	OLV
IMBALLO	2	2



art. 7.4760

finale a tappo per bastone

MISURA	ø 13 mm	ø 20 mm	ø 25 mm
FINITURA	OLV	OLV	OLV
IMBALLO	10	10	10



art. 7.4765

finale a tappo aperto per bastone

MISURA	ø 13 mm	ø 20 mm	ø 25 mm
FINITURA	OLV	OLV	OLV
IMBALLO	10	10	10



art. 7.4770

finale a tappo chiuso per bastone

MISURA	ø 20 mm	ø 25 mm	ø 30 mm	ø 35 mm
FINITURA	OLV	OLV	OLV	OLV
IMBALLO	20	20	20	20



art. 7.4775

finale a tappo passante per bastone

MISURA	ø 20 mm	ø 25 mm	ø 30 mm	ø 35 mm
FINITURA	OLV	OLV	OLV	OLV
IMBALLO	20	20	20	20



art. 7.4778

finale a cupola per bastone

MISURA	ø 13 mm	ø 20 mm	ø 25 mm
FINITURA	OLV	OLV	OLV
IMBALLO	10	10	10

serie **MENSOLE PER TENDE**



art. 6.1570

mensola estensibile

	6.1570	6.1571
MISURA	da 80 a 115 mm	da 80 a 160 mm
FINITURA	FERRO NR	FERRO NR
IMBALLO	20	20

	6.1570G	-
FINITURA	FERRO NR ORO	-



art. 6.1572

mensola doppia

MISURA	ø 115 mm
FINITURA	FERRO NR
IMBALLO	20



art. 7.4780

mensola passante

MISURA	ø 20 mm	ø 25 mm	ø 30 mm	ø 35 mm
FINITURA	OLV	OLV	OLV	OLV
IMBALLO	6	6	6	6

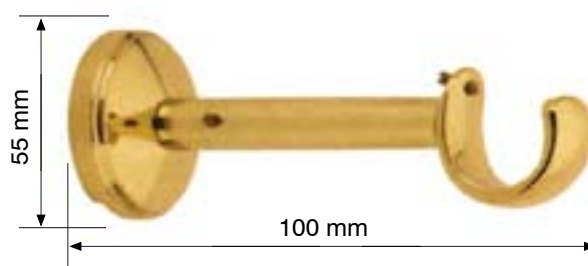

art. 7.4785

mensola aperta

MISURA	ø 20 mm	ø 25 mm	ø 30 mm	ø 35 mm
FINITURA	OLV	OLV	OLV	OLV
IMBALLO	6	6	6	6



art. 7.4790

mensola passante

MISURA	ø 13 mm	ø 20 mm	ø 25 mm
FINITURA	OLV	OLV	OLV
IMBALLO	6	6	6



art. 7.4795

mensola aperta

MISURA	ø 13 mm	ø 20 mm	ø 25 mm
FINITURA	OLV	OLV	OLV
IMBALLO	6	6	6

SUPPORTI PER CORRIMANO



art. 6.0070

supporto per corrimano quadro

FINITURA	OLV	BR	CR	CRS
IMBALLO	24	24	24	24



art. 6.0071

supporto per corrimano
con viti in vista

FINITURA	OLV	OGR
IMBALLO	24	24



art. 6.0073

supporto per corrimano
con testa piana e base \varnothing 56 mm

FINITURA	OLV	OGR	CR	CRS
IMBALLO	24	24	24	24



art. 6.0074

supporto per corrimano
con testa concava e base \varnothing 56 mm

FINITURA	OLV	OGR	CR	CRS
IMBALLO	24	24	24	24



art. 6.0075

supporto per corrimano
con testa piana e base \varnothing 43 mm

FINITURA	OLV
IMBALLO	24



art. 6.0080

supporto per corrimano
con testa piana e base \varnothing 53 mm

FINITURA	OLV	OGR	CR	CRS
IMBALLO	24	24	24	24



art. 6.0081

supporto per corrimano
con testa concava e base \varnothing 53 mm

FINITURA	OLV	OGR	CR	CRS
IMBALLO	24	24	24	24

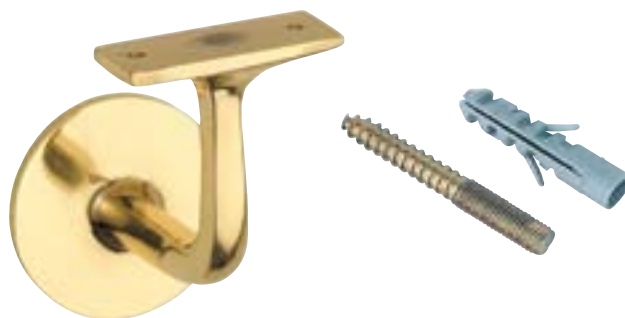

art. 6.0085

supporto per corrimano
con testa piana Slim

FINITURA	OLV	OGR
IMBALLO	24	24



art. 6.0088

supporto per corrimano passante dritto
per tubo \varnothing 35 mm - sporgenza 106 mm
e base \varnothing 56 mm

FINITURA	OLV	OGR	CR	CRS
IMBALLO	6	6	6	6



art. 6.0089

supporto per corrimano passante curvo
per tubo \varnothing 35 mm - sporgenza 115 mm
e base \varnothing 56 mm

FINITURA	OLV	OGR	CR	CRS
IMBALLO	6	6	6	6



art. 6.3150

finale per corda

MISURA	\varnothing 20 mm	\varnothing 30 mm	\varnothing 35 mm
FINITURA	OLV	OLV	OLV
IMBALLO	24	24	24

serie **REGGIMENSOLE**



art. 6.1440

reggimensola artistica
125x172x22

FINITURA	OLV
IMBALLO	12

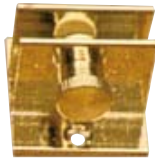

art. 6.1450

reggimensola a morsetto
25x25 mm - base int. 8 mm

FINITURA	OL	NIK
IMBALLO	30	30

art. 6.1451

reggimensola a morsetto
25x30 mm - base int. 8 mm

FINITURA	OL	NIK
IMBALLO	30	30

art. 6.1452

reggimensola a morsetto
25x40 mm - base int. 8 mm

FINITURA	OL	NIK
IMBALLO	30	30



art. 6.1455

reggimensola a morsetto
25x20 mm - spessore max 10 mm

FINITURA	OL	NIK
IMBALLO	30	30

art. 6.1456

reggimensola a morsetto
25x25 mm - spessore max 10 mm

FINITURA	OL	NIK
IMBALLO	30	30

art. 6.1457

reggimensola a morsetto
25x30 mm - spessore max 10 mm

FINITURA	OL	NIK
IMBALLO	30	30



art. 6.1458

reggimensola a morsetto
25x35 mm - spessore max 10 mm

FINITURA	OL	NIK
IMBALLO	30	30

art. 6.1459

reggimensola a morsetto
25x40 mm - spessore max 10 mm

FINITURA	OL	NIK
IMBALLO	30	30

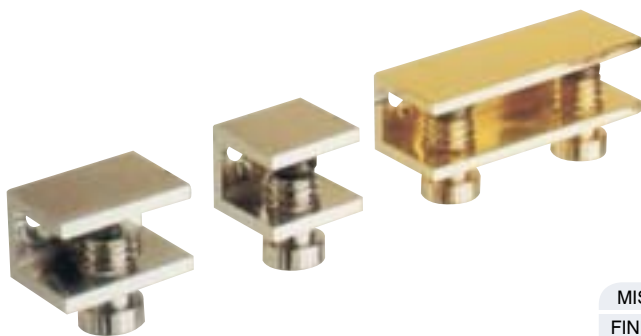

art. 6.1460

reggimensola a morsetto normale spessore max 10 mm

	6.1460	6.1461	6.1462	6.1463	6.1464
MISURA	15x15 mm	15x20 mm	15x25 mm	15x30 mm	15x35 mm
FINITURA	OL	OL	OL	OL	OL
IMBALLO	30	30	30	30	30

FINITURA	NIK	NIK	NIK	NIK	NIK
----------	-----	-----	-----	-----	-----

**art. 6.1420**reggimensola per vetro fresata
ø 23 mm - spessore max 10 mm

FINITURA	OLV	CROM	CRS
IMBALLO	25	25	25

**art. 6.1430**reggimensola per specchio
ø 25 mm

FINITURA	OLV	CROM	CRS
IMBALLO	25	25	25

**art. 6.1435**reggimensola per vetrine
ø 20 mm - spessore max 8 mm

FINITURA	OLV	CR	CRS
IMBALLO	25	25	25

**art. 6.1465**reggimensola
38X18 mm - int. 12 mm

FINITURA	OLV	CR	CRS
IMBALLO	20	20	20

**art. 6.1466**reggimensola
38x18 mm - int. 8 mm

FINITURA	OLV	CR	CRS
IMBALLO	20	20	20

**art. 6.1470**

reggimensola per vetro

	6.1470	6.1471	6.1472
MISURA	20x25 mm	25x25 mm	25x30 mm
SPESS. MAX	8 mm	11 mm	14 mm
FINITURA	OLV	OLV	OLV
IMBALLO	24	24	24

FINITURA	NIK	NIK	NIK
----------	-----	-----	-----

**art. 6.1480**reggimensola per vetro
50x30 mm - spessore max 10 mm

FINITURA	OLV	CR	CRS
IMBALLO	12	12	12

**art. 6.1490**reggimensola per vetro
70x30 mm - spessore max 10 mm

FINITURA	OLV	CR	CRS
IMBALLO	12	12	12

**art. 6.1510**reggimensola per vetro
25x20 mm - int. 12 mm

FINITURA	OLV	CR	CRS
IMBALLO	24	24	24

**art. 6.1515**reggimensola ad angolo
int. 12 mm

FINITURA	OLV	CR	CRS
IMBALLO	12	12	12



art. 6.1520

reggimensola

	6.1520.10	6.1520.15	6.1520.20
MISURA	100 mm	150 mm	200 mm
FINITURA	OL	OL	OL
IMBALLO	12	12	12
FINITURA	NIK	NIK	NIK

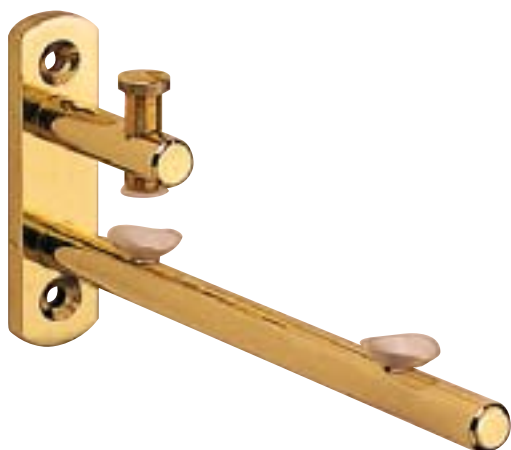

art. 6.1530

reggimensola

	6.1530.10	6.1530.15	6.1530.20
MISURA	100 mm	150 mm	200 mm
FINITURA	OL	OL	OL
IMBALLO	12	12	12
FINITURA	NIK	NIK	NIK

art. 6.1540

reggimensola con sostegno di rinforzo

	6.1540.10	6.1540.15	6.1540.20
MISURA	100 mm	150 mm	200 mm
FINITURA	OL	OL	OL
IMBALLO	12	12	12
FINITURA	NIK	NIK	NIK



art. 6.1560

reggimensola Smart con foro 4 ma, vite e tassello

FINITURA	NR	CR	CRS	NIK MAT	BN	NN	OLV	SAT	BR	ANT
IMBALLO	25	25	25	25	25	25	25	25	25	25

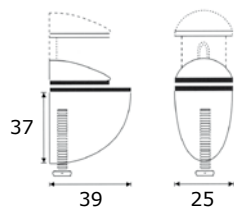

art. 6.1582

reggimensola Tuc piccolo
37x39x25 mm - spessore max 14 mm

FINITURA	CR	CRS	NIK.M
IMBALLO	10	10	10

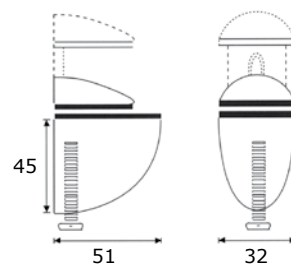

art. 6.1583

reggimensola Tuc grande
45x51x32 mm - spessore max 22 mm

FINITURA	CR	CRS	NIK.M
IMBALLO	10	10	10



art. 6.1590

reggimensola

MISURA	190x140 mm	240x190 mm
FINITURA	ACC. CR	ACC. CR
IMBALLO	6	6

ACCESSORI VARI

PINZE



art. 5.5340

pinza con incontro ad avvitare
completa di viti e tassello

FINITURA	NYLON NR
IMBALLO	50

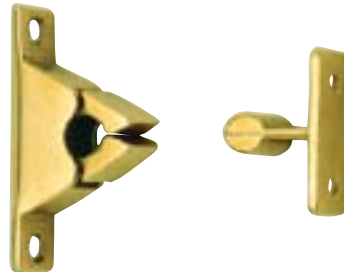

art. 6.0001

pinza fermaporta
con incontro ad avvitare

FINITURA	OL	BR
IMBALLO	50	50

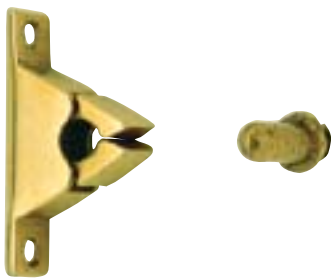

art. 6.0005

incontro per pinza fermaporta
ad avvitare

FINITURA	OL	BR
IMBALLO	50	50

art. 6.0002

pinza fermaporta
con incontro a piombare

FINITURA	OL	BR
IMBALLO	50	50



art. 6.0006

incontro per pinza fermaporta
a piombare

FINITURA	OL	BR
IMBALLO	50	50



art. 6.0300

pinza ottone trafilato
inc. piolo

FINITURA	OLV
IMBALLO	50

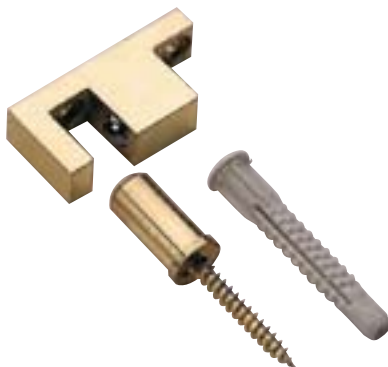

art. 6.0310

pinza ottone trafilato
inc. tassello

FINITURA	OLV
IMBALLO	50



art. 6.0320

pinza ottone trafilato
inc. parete

FINITURA	OLV
IMBALLO	50

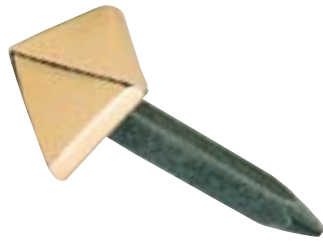

art. 6.3300

chiodo a piramide per portone
20x20 mm

FINITURA	OL	BR
IMBALLO	24	24

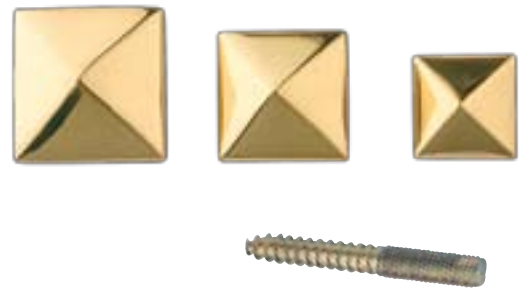

art. 6.3305

chiodo a piramide con vite separata

MISURA	20x20 mm	25x25 mm	30x30 mm
FINITURA	OL	OL	OL
IMBALLO	50	50	50

FINITURA	ANT	ANT	ANT
----------	-----	-----	-----



art. 6.0050

borchia copridado ottagonale
ø 30 mm

FINITURA	OLV	OGR	CRS
IMBALLO	24	24	24



art. 6.0051

borchia copridado tonda
ø 30 mm

FINITURA	OLV	OGR	CRS
IMBALLO	24	24	24



art. 6.0052

borchia coprifiletto esagonale
ø 22 mm - h. 12 mm

FINITURA	OLV	ANT	CRS
IMBALLO	25	25	25



art. 6.0058

borchia copridado
ø 30 mm

FINITURA	OLV	BR
IMBALLO	50	50



art. 6.0021

cricchetto per sopra-
luce con incontro ad angolo

FINITURA	OL
IMBALLO	50



art. 6.0022

cricchetto per sopra-
luce con incontro piano

FINITURA	OL
IMBALLO	50

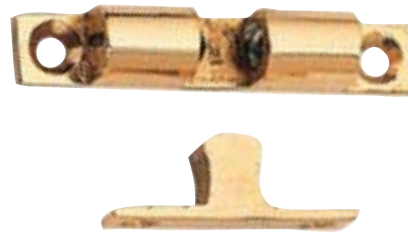

art. 6.0027

cricchetto a sfera

	6.0027.42	6.0027.50	6.0027.60	6.0027.70
MISURA	42 mm	50 mm	60 mm	70 mm
FINITURA	OLV	OLV	OLV	OLV
IMBALLO	24	24	24	24

NODO e TERMINALE



art. 6.3120

nodo liscio

	6.3120.12	6.3120.14
MISURA	ø 30 - foro 12 mm	ø 30 - foro 14 mm
FINITURA	OLV	OLV
IMBALLO	12	12

	6.3120.16	6.3120.18
MISURA	ø 30 - foro 16 mm	ø 30 - foro 18 mm
FINITURA	OLV	OLV
IMBALLO	12	12



art. 6.3125

terminale

	6.3125.12	6.3125.14
MISURA	ø 30 - foro 12 mm	ø 30 - foro 14 mm
FINITURA	OLV	OLV
IMBALLO	24	24

	6.3125.16	6.3125.18
MISURA	ø 30 - foro 16 mm	ø 30 - foro 18 mm
FINITURA	OLV	OLV
IMBALLO	24	24



art. 6.0095

tavellino rettangolare a scatto
50x70 mm - con incontro 16 mm

FINITURA	OLV	OGR
IMBALLO	20	20

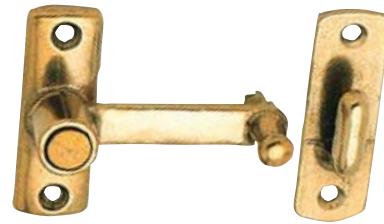

art. 6.0100

tavellino a scatto con incontro

	6.0100.05	6.0100.10	6.0100.15	6.0100.20	6.0100.25	6.0100.30
MISURA	5 mm	10 mm	15 mm	20 mm	25 mm	30 mm
FINITURA	OL	OL	OL	OL	OL	OL
IMBALLO	50	50	50	50	50	50
FINITURA	BR	BR	BR	BR	BR	BR



art. 6.0108

tavellino a scatto tipo pesante
5 - 15 - 20 - 25 mm

FINITURA	OL	BZ
IMBALLO	25	25

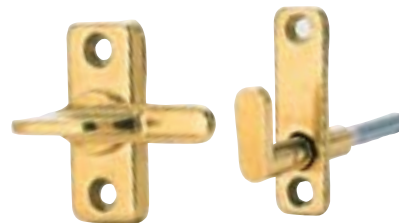

art. 6.0101

tavellino regolabile

FINITURA	OLV	BZ
IMBALLO	25	25

FINALE e PASSANTE



art. 6.0105

fermaschuro 80 mm su rosetta
con incontro 5 - 25 - 30 mm

FINITURA	OLV	OGR
IMBALLO	20	20



art. 6.0033

passante per aste esterne

FINITURA	OLV	OGR	CR	CRS
IMBALLO	25	25	25	25



art. 6.0035

finale per aste esterne

FINITURA	OLV	OGR	CR	CRS
IMBALLO	25	25	25	25

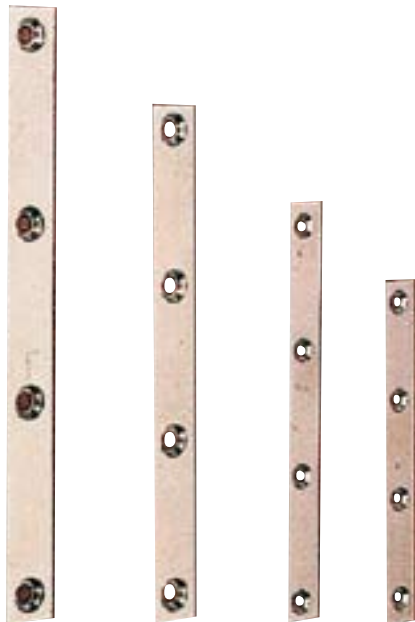

art. 6.2010

aste piane svasate

MISURA	60 mm	80 mm	100 mm	120 mm
FINITURA	OL	OL	OL	OL
IMBALLO	50	50	50	50

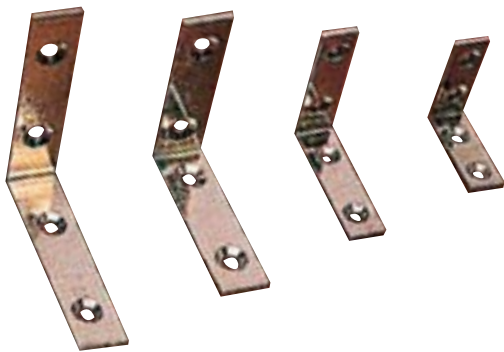

art. 6.2000

angolare reggipiano

MISURA	30x30 mm	40x40 mm	50x50 mm	60x60 mm
FINITURA	OL	OL	OL	OL
IMBALLO	50	50	50	50

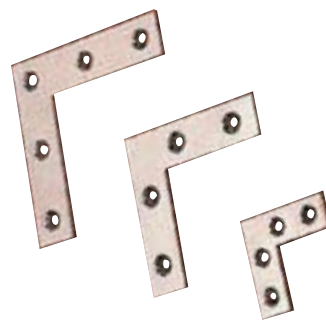

art. 6.2015

angolare piano

MISURA	30x30 mm	45x45 mm	60x60 mm
FINITURA	OL	OL	OL
IMBALLO	50	50	50



art. 6.1445

angolare liscio
51x51 mm - h. 17 mm

FINITURA	OLV
IMBALLO	12



art. 6.1446

angolare decorato
63x63 mm - h. 23 mm

FINITURA	OLV
IMBALLO	12



art. 6.0110

cavalotto a rullo

	6.0110.10	6.0110.15	6.0110.18
MISURA	10 mm	15 mm	18 mm
FINITURA	OL	OL	OL
IMBALLO	100	100	100

	6.0110.20	6.0110.22	6.0110.25	6.0110.30
MISURA	20 mm	22 mm	25 mm	30 mm
FINITURA	OL	OL	OL	OL
IMBALLO	100	100	100	100

GUIDA LUCERNARI



01



02



03

art. 6.0030

guida per lucernari con incontro

	6.0030.01	6.0030.02	6.0030.03
FINITURA	OL	OL	OL
IMBALLO	25	25	25

MANIGLIA BLOCCO



art. 6.0120

maniglia Blocco

	6.0120 DX	6.0121 SX
FINITURA	OL	OL
IMBALLO	12	12

FINITURA	BR	BR
----------	----	----



art. 6.0060

pozzuolo con molla

	6.0060.06	6.0060.08	6.0060.10	6.0060.12
MISURA	ø 6 mm	ø 8 mm	ø 10 mm	ø 12 mm
FINITURA	OL	OL	OL	OL
IMBALLO	50	50	50	50

	6.0060.14	6.0060.16	6.0060.18	6.0060.20	6.0060.22
MISURA	ø 14 mm	ø 16 mm	ø 18 mm	ø 20 mm	ø 22 mm
FINITURA	OL	OL	OL	OL	OL
IMBALLO	50	50	50	50	50

DISTANZIALI
DISTANZIALI



art. 7.0310

distanziale per targhe
ø 14 mm

FINITURA	OLV	SAT	OGR	CR	CRS
IMBALLO	25	25	25	25	25

TIRADOR
TIRADOR



art. 9.0103

tirador per scorrevole tipo Eko

FINITURA	OLV	OGR
IMBALLO	12	12



art. 9.0105

tirador per scorrevole tipo Sfera

FINITURA	OLV	OGR
IMBALLO	12	12

SPIONCINO
SPIONCINO



art. 9.0531.02

spioncino ø 14 mm
da 50 a 80 mm

FINITURA	OLV	CR	CRS
IMBALLO	12	12	12



art. 9.0531.03

spioncino ø 14 mm
da 70 a 110 mm

FINITURA	OLV	CR	CRS
IMBALLO	12	12	12

DK DI SICUREZZA

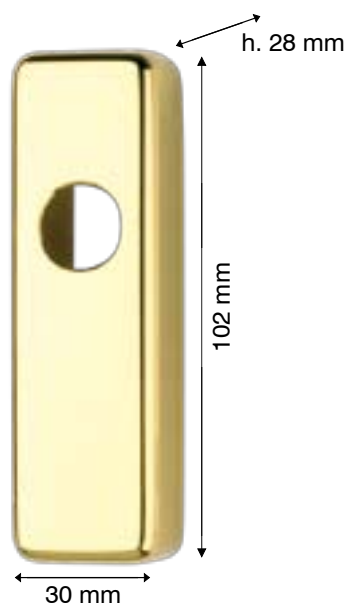
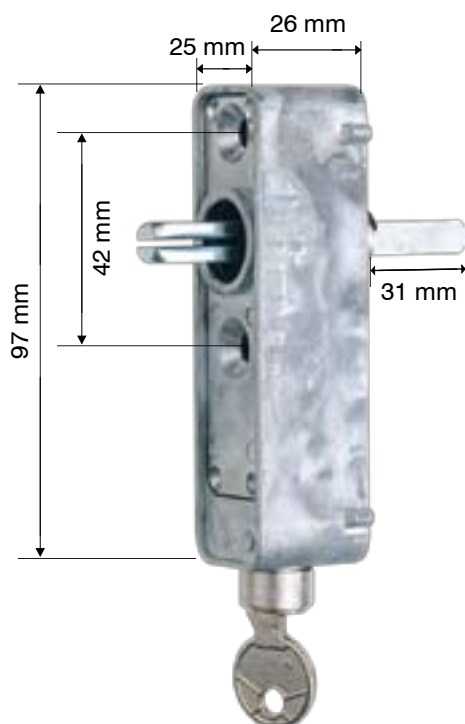

art. 9.0067

dk di sicurezza con serratura
utilizzabile con tutti i tipi di maniglie

FINITURA	OLV	OGR	SAT	CR	CRS
IMBALLO	2	2	2	2	2

**AL PREZZO INDICATO VA AGGIUNTO
IL COSTO DELL'IMPUGNATURA SCELTA**

PROTEZIONE CILINDRO



art. 5.4320

protezione corazzata per cilindro

FINITURA	OLV	OGR	CRS	PVD
IMBALLO	1	1	1	1



DISPONIBILI FINO AD ESAURIMENTO SCORTE

art. 3.2300

skin portabito gigante
misura A 60x27x57 mm - 1 pezzo

FINITURA	Z. BN
IMBALLO	20

FINITURA	Z. ORO
----------	--------

FINITURA	Z. NR
----------	-------



DISPONIBILI FINO AD ESAURIMENTO SCORTE

art. 3.2310

skin portabito gigante
misura B 40x28x38 mm - 2 pezzi

FINITURA	Z. BN
IMBALLO	20

FINITURA	Z. ORO
----------	--------

FINITURA	Z. NR
----------	-------



art. 5.590I

skin gancio a goccia
29x15x11 mm - 5 pezzi

FINITURA	Z. BN
IMBALLO	50

FINITURA	Z. ORO
----------	--------

FINITURA	Z. NR
----------	-------



art. 5.5910

skin gancio a goccia forata
5 pezzi

FINITURA	Z. ORO
IMBALLO	50



DISPONIBILI FINO AD
ESAURIMENTO SCORTE

art. 5.5920

skin gancio bottoncino forato
5 pezzi

FINITURA	Z. ORO
IMBALLO	50



DISPONIBILI FINO AD
ESAURIMENTO SCORTE

art. 5.5930

skin gancio quadrifoglio grande
4 pezzi

FINITURA	OL
IMBALLO	25

art. 5.5935

skin gancio quadrifoglio piccolo
4 pezzi

FINITURA	OL
IMBALLO	25



DISPONIBILI FINO AD
ESAURIMENTO SCORTE

art. 5.5940

skin gancio tulipano grande
4 pezzi

FINITURA	OL
IMBALLO	25

art. 5.5945

skin gancio tulipano piccolo
4 pezzi

FINITURA	OL
IMBALLO	25



FINITURA	Z. OTT	Z. BR
IMBALLO	25	25

art. 5.5950

skin gancio giglio piccolo
5 pezzi

art. 5.5955

skin gancio giglio medio
5 pezzi

FINITURA	Z. OTT	Z. BR
IMBALLO	25	25



DISPONIBILI FINO AD
ESAURIMENTO SCORTE

art. 5.5960

skin gancio triangolo
4 pezzi

FINITURA	OL
IMBALLO	25



DISPONIBILI FINO AD
ESAURIMENTO SCORTE

art. 5.5970

skin gancio margherita
4 pezzi

FINITURA	OL
IMBALLO	25



art. 5.5980

skin gancio Luna
5 pezzi

FINITURA	OL
IMBALLO	25

DISPONIBILI FINO AD
ESAURIMENTO SCORTE

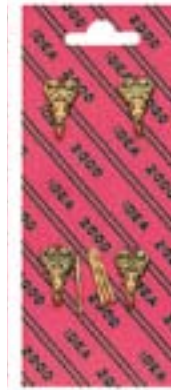

art. 5.5990

skin gancio Barocco
4 pezzi

FINITURA	OL
IMBALLO	25

DISPONIBILI FINO AD
ESAURIMENTO SCORTE



art. 6.0048

skin fermaporta
ø 20 mm - 1 pezzi

FINITURA	OTT/NR	OTT/BN
IMBALLO	20	20

DISPONIBILI FINO AD
ESAURIMENTO SCORTE

art. 6.1300

skin appendiquadri tondino ø 6 mm
con applicatore 4 pezzi

FINITURA	Z. ORO
IMBALLO	50



art. 6.1310

skin appendiquadri in ottone
5 pezzi

FINITURA	OL	BR
IMBALLO	50	50

DISPONIBILI FINO AD
ESAURIMENTO SCORTE

art. 6.1320

skin gancio snodato
2 pezzi

FINITURA	Z. BR	Z. ORO
IMBALLO	50	50



art. 6.1600

skin gancio fiocco
5 pezzi

FINITURA	ACC. ORO
IMBALLO	25

DISPONIBILI FINO AD
ESAURIMENTO SCORTE



art. 6.1610

skin gancio foglie
5 pezzi

FINITURA	ACC. ORO
IMBALLO	25

DISPONIBILI FINO AD
ESAURIMENTO SCORTE



art. 6.1620

skin gancio tondo
16x34 mm - 5 pezzi

FINITURA	ACC. ORO
IMBALLO	25

DISPONIBILI FINO AD
ESAURIMENTO SCORTE



art. 6.1630

skin gancio stamma
5 pezzi

FINITURA	ACC. ORO
IMBALLO	25

DISPONIBILI FINO AD
ESAURIMENTO SCORTE



art. 6.1690

skin gancio rosa
5 pezzi

FINITURA	ACC. ORO
IMBALLO	25

DISPONIBILI FINO AD
ESAURIMENTO SCORTE



art. 7.4090

skin catena di sicurezza
1 pezzi

FINITURA	OLV
IMBALLO	25



art. 9.8050

armadio espositore
profondità 51 cm
altezza 190 cm
fronte 100 cm

pannello apribile
per scorte di prodotti



art. 9.8000

espositore girevole



Art. 9.0070
Gioco gratz fori
50 pezzi

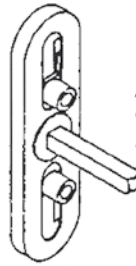

Art. 9.0095
Gioco gratz bussole + $\varnothing 7$
50 pezzi

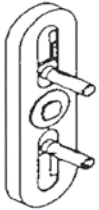

Art. 9.0080
Gioco gratz perni
50 pezzi

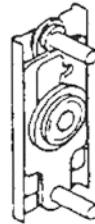

Art. 9.0120
Gioco MP
50 pezzi

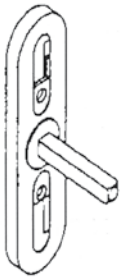

Art. 9.0075
Gioco gratz perni + $\varnothing 7$
50 pezzi

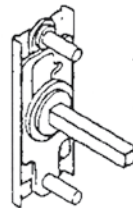

Art. 9.0125
Gioco MP + $\varnothing 7$
50 pezzi

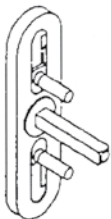

Art. 9.0085
Gioco gratz perni + $\varnothing 7$
50 pezzi

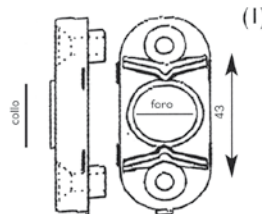

Art. 9.0062
Movimento DK speciale con viti
(movimento (1) + rotore (2) che è quello
che fa scattare il movimento)

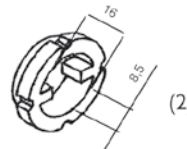

Art. 9.0090
Gioco gratz bussole
50 pezzi

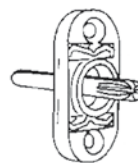

Art. 9.0060
Movimento DK ovale $\varnothing 7 \times 45$ nylon
50 pezzi

Art. 9.0065
Movimento DK ovale $\varnothing 7 \times 45$ Acciaio ottone
50 pezzi

**Art. 9.0135**

Piastrina con \varnothing 8 base quadrata
50 pezzi

**Art. 9.0140**

Piastrina con filetto 8 MA base tonda
50 pezzi

**Art. 9.0786**

Vite per giunzione 4 ma conf. pz. 100
Vite per giunzione 6 ma conf. pz. 100
Vite per giunzione 8 ma conf. pz. 100

**Art. 9.0781**

Vite 4 ma x 20 conf. pz. 500
Vite 4 ma x 25 conf. pz. 500
Vite 4 ma x 30 conf. pz. 500
Vite 4 ma x 40 conf. pz. 500

**Art. 9.0782**

Vite 4 ma x 40 pretagliata conf. pz. 100
Vite 4 ma x 50 pretagliata conf. pz. 100

**Art. 9.0785**

Confezione 2 pezzi vite per copr. Magic 3,5x9,5

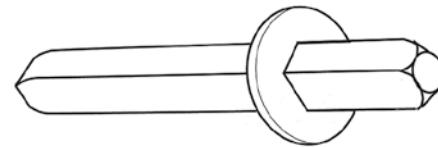
**Art. 9.0045**

Ferro \varnothing 7 con rondella per martelline conf. pz. 50

**Art. 9.0784**

Confezione 2 pezzi vite per copr. Vimar 3x9

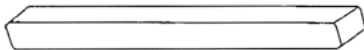
**Art. 9.0200**

Ferro quadro 6x100 100 pezzi
Ferro quadro 7x 75 100 pezzi
Ferro quadro 7x100 100 pezzi
Ferro quadro 8x120 100 pezzi
Ferro quadro 8x140 100 pezzi

**Art. 9.0203**

Ferro tagliato e fresato 1 lato con rondella in testa
 \varnothing 8x80 100 pezzi

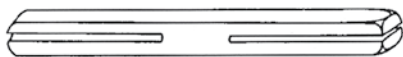
**Art. 9.0201**

Ferro fresato \varnothing 8x90 100 pezzi
Ferro fresato \varnothing 8x100 100 pezzi
Ferro fresato \varnothing 8x120 100 pezzi

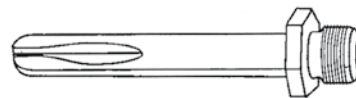
**Art. 9.0204**

Ferro con nipples 10 MA \varnothing 8x90 20 pezzi
Ferro con nipples 10 MA \varnothing 8x100 20 pezzi

**Art. 9.0202**

Ferro ad espansione \varnothing 8x48 20 pezzi
Ferro ad espansione \varnothing 8x55 20 pezzi
Ferro ad espansione \varnothing 8x65 20 pezzi
Ferro ad espansione \varnothing 8x80 20 pezzi

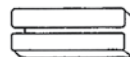
**Art. 9.0205**

Riduzione plastica del 7 a 6 100 pezzi
Riduzione plastica del 8 a 6 100 pezzi
Riduzione plastica del 8 a 7 100 pezzi
Riduzione plastica del 8 a 9 100 pezzi

PLACCHE MANIGLIE



cod. 10
placca per maniglie
226x38 mm



cod. 10 PESANTE
placca per maniglie
230x38 mm



cod. 11
placca per maniglie
240x42 mm



cod. 12
placca per maniglie
247x38 mm



cod. 13
placca per maniglie
246x39 mm



cod. 17
placca per maniglie
232x28 mm



cod. 18
placca per maniglie
185x40 mm



cod. 19
placca per maniglie
224x35 mm



cod. 22
placca per maniglie
253x43 mm



cod. 31
placca per maniglie
252x39 mm



art. 2.0008
placca "G" per maniglie
280x50 mm



art. 2.0007
placca "B" per maniglie
270x55 mm



cod. 2.0009
placca "K" per maniglie
247x47 mm

PLACCHE CREMONESI



cod. 10

placca per cremonesi o martellina
175x38 mm



cod. 11

placca per cremonesi o martellina
179x39 mm



cod. 12

placca per cremonesi o martellina
179x39 mm



cod. 19

placca per cremonesi
o martellina 160x37 mm



art. 21

placca per cremonesi
o martellina 141x35 mm



art. 22

placca per cremonesi
o martellina 164x38 mm



cod. 31

placca per cremonesi
o martellina 180x39 mm

ROSETTA



cod. 60

rosetta per dk ovale
61x31 mm



cod. 70

rosetta per dk rettangolare
61x31 mm



MANIGLIA DESTRA



MANIGLIA SINISTRA

IMPORTO EXTRA DA AGGIUNGERE AL PREZZO LORDO PER LAVORAZIONI GALVANICHE

ORO/ANT CR/CRS ARG/ANT PVD

maniglia su placca - rosetta \varnothing 45 mm - rosetta 3 fori (artistica)

maniglia su rosetta \varnothing 50 mm

maniglia su rosetta quadra 50x50 mm

cremonese - martellina - dk - copriavvolgibile - pomolo

battente

maniglione

Cottali

- Per praticità di presentazione tutte le foto riportate a catalogo rispondono alle finiture più versatili e comunque nella versione che a nostro giudizio risultano più confacenti.

- Tutte le maniglie riportate a catalogo possono essere eseguite con tutti i modelli di rosette e placche nelle finiture riportate a pagina 282 del catalogo.

- COSTI E MODIFICHE:

a pagina 280-281 del catalogo sono illustrate tutte le versioni di placca disponibili.

- ROSETTE OVALI:

tutte le maniglie possono essere eseguite con rosetta ovale applicando una maggiorazione di Euro 2,00 (*DUE*) a guarnitura o coppia.

- ROSETTE AD AVVITARE:

tutte le maniglie possono essere eseguite con rosetta ad avvitare \varnothing 45 mm Lux (*dove non riportate*) con una maggiorazione di EURO 10,00 (*DIECI*) o con rosetta ad avvitare \varnothing 50 mm con una maggiorazione di EURO 8,00 (*OTTO*).

N.B. l'importo delle maggiorazioni si intende lordo per coppia o guarnitura.

- Le finiture in SAT ottone satinato e OGR bronzato sfumato graffiato hanno lo stesso costo.

- Le finiture in CR cromo lucido e CRS cromo satinato hanno lo stesso costo.

- L'azienda si riserva a suo insindacabile giudizio qualsiasi modifica senza necessariamente dare alcuna informazione.



CONDIZIONI di VENDITA

ORDINI:

Gli ordini si intendono accettati all'approvazione Cottali.

PREZZI:

Si intendono IVA esclusa e per merce franco fabbrica.

PAGAMENTI:

Il pagamento delle fatture deve essere fatto direttamente alla ditta Cottali.

Non sono accettate trattenute o arrotondamenti.

In caso di ritardato pagamento verranno applicate spese ed interessi commerciali.

CONSEGNE:

I termini di consegna sono da considerarsi non rigidi e salvo imprevisti.

Il ritardato invio della merce per qualsiasi motivo non dà diritto ad indennizzi.

Per motivi gestionali la ditta Cottali si riserva il diritto di invii frazionati.

SPEDIZIONI:

La merce viaggia a rischio e pericolo del Committente anche se spedita in porto franco;

eventuali reclami sono ritenuti validi solo se effettuati entro otto giorni dal ricevimento della merce.

RECLAMI:

Trascorsi otto giorni dal ricevimento della merce, non verranno presi in considerazione.

Eventuali restituzioni devono aver ricevuto l'approvazione della ditta Cottali.

SEDE LEGALE:

Per qualsiasi controversia, sarà competente il Foro di Brescia.