

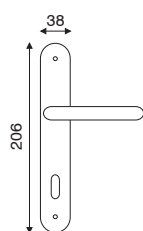

serie **OMEGA**



**art. MA 2.1910**

guarnitura con placca

|          |         |          |
|----------|---------|----------|
| FINITURA | ALL. BR | ALL. ARG |
| IMBALLO  | 10      | 10       |

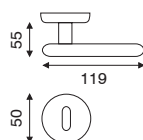

**art. MA 2.1968**

guarnitura rosetta e bocchetta  
ø 50 mm a pressione

|          |         |          |
|----------|---------|----------|
| FINITURA | ALL. BR | ALL. ARG |
| IMBALLO  | 10      | 10       |

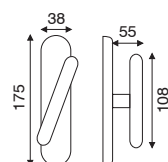

**art. FI 2.1910**

cremonese o martellina

|          |         |          |
|----------|---------|----------|
| FINITURA | ALL. BR | ALL. ARG |
| IMBALLO  | 10      | 10       |

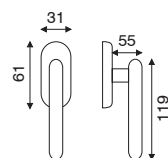

**art. FI 2.1960**

dk movimento in fibra

|          |         |          |
|----------|---------|----------|
| FINITURA | ALL. BR | ALL. ARG |
| IMBALLO  | 10      | 10       |



3130 Serie  
**THEA**

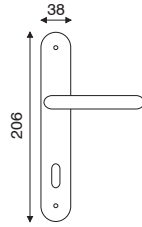

**art. 1.6410**

guarnitura con placca

| FINITURA | ALL. BR | ALL. ARG |
|----------|---------|----------|
| IMBALLO  | 10      | 10       |

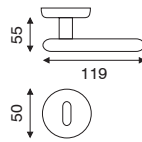

**art. 1.6468**

guarnitura rosetta e bocchetta  
ø 50 mm a pressione

| FINITURA | ALL. BR | ALL. ARG |
|----------|---------|----------|
| IMBALLO  | 10      | 10       |

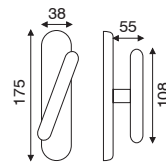

**art. 4.6410**

cremonese o martellina

| FINITURA | ALL. BR | ALL. ARG |
|----------|---------|----------|
| IMBALLO  | 10      | 10       |

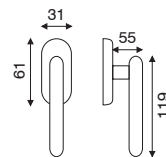

**art. 4.6460**

dk movimento in fibra

| FINITURA | ALL. BR | ALL. ARG |
|----------|---------|----------|
| IMBALLO  | 10      | 10       |

# LINEA ACCIAIO INOX



## art. 3.2955

maniglia incasso ovale  
est. 120x40 mm - int. 92x28 mm

|          |          |
|----------|----------|
| FINITURA | ACC. SAT |
| IMBALLO  | 12       |



## art. 3.2740

maniglia incasso tonda  
est. ø 65 mm - int. ø 50 mm

|          |          |
|----------|----------|
| FINITURA | ACC. SAT |
| IMBALLO  | 12       |



## art. 3.2870

coppia nottolino wc Q6  
con rosetta ø 50 mm a pressione

|          |          |
|----------|----------|
| FINITURA | ACC. SAT |
| IMBALLO  | 5        |



## art. 3.2500.06

maniglia bastoncino ø 10x64 mm

|          |          |
|----------|----------|
| FINITURA | ACC. SAT |
| IMBALLO  | 25       |



## art. 3.2500.09

maniglia bastoncino ø 10x96 mm

|          |          |
|----------|----------|
| FINITURA | ACC. SAT |
| IMBALLO  | 25       |
| EURO     | 7,90     |



315 Serie **CAPRIX**

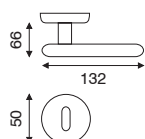

**art. 1.8368**  
guarnitura rosetta e bocchetta  
ø 50 mm a pressione

|          |          |
|----------|----------|
| FINITURA | ACC. SAT |
| IMBALLO  | 1        |

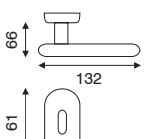

**art. 1.8363**  
guarnitura rosetta e bocchetta  
ovale 31x61 mm

|          |          |
|----------|----------|
| FINITURA | ACC. SAT |
| IMBALLO  | 1        |

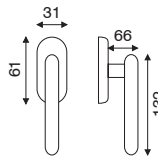

**art. 4.8360**  
dk movimento in fibra

|          |          |
|----------|----------|
| FINITURA | ACC. SAT |
| IMBALLO  | 2        |



315 Serie **OLARIX**

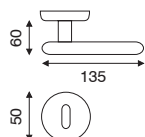

**art. 1.4868**  
guarnitura rosetta e bocchetta  
ø 50 mm a pressione

|          |          |
|----------|----------|
| FINITURA | ACC. SAT |
| IMBALLO  | 1        |

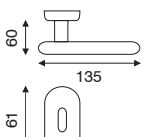

**art. 1.4863**  
guarnitura rosetta e bocchetta  
ovale 31x61 mm

|          |          |
|----------|----------|
| FINITURA | ACC. SAT |
| IMBALLO  | 1        |

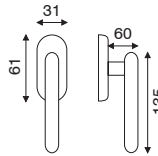

**art. 4.4860**  
dk movimento in fibra

|          |          |
|----------|----------|
| FINITURA | ACC. SAT |
| IMBALLO  | 2        |



315 Serie **NOVANTA**

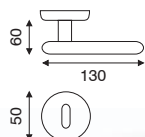

**art. MA 2.1468**  
guarnitura rosetta e bocchetta  
ø 50 mm a pressione

|          |          |
|----------|----------|
| FINITURA | ACC. SAT |
| IMBALLO  | 1        |

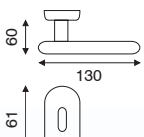

**art. MA 2.1463**  
guarnitura rosetta e bocchetta  
ovale 31x61 mm

|          |          |
|----------|----------|
| FINITURA | ACC. SAT |
| IMBALLO  | 1        |

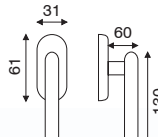

**art. FI 2.1460**  
dk movimento in fibra

|          |          |
|----------|----------|
| FINITURA | ACC. SAT |
| IMBALLO  | 2        |

# LINEA PLASTICA



## MARE

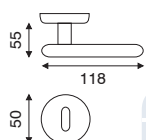

### art. 1.0460

guarnitura rosetta e bocchetta in plastica  
ø 50 mm a pressione

| FINITURA | BN | NR |
|----------|----|----|
| IMBALLO  | 10 | 10 |

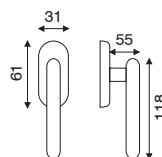

### art. 4.0460

dk movimento in fibra

| FINITURA | BN | NR |
|----------|----|----|
| IMBALLO  | 10 | 10 |



## MOON

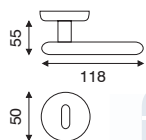

### art. 1.0470

guarnitura rosetta e bocchetta in plastica  
ø 50 mm a pressione

| FINITURA | BN | NR |
|----------|----|----|
| IMBALLO  | 10 | 10 |

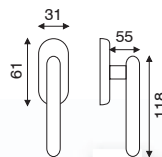

### art. 4.0470

dk movimento in fibra

| FINITURA | BN | NR |
|----------|----|----|
| IMBALLO  | 10 | 10 |



### art. 3.2100

pomolo fisso  
ø 75 mm - perno passante

|          |      |      |
|----------|------|------|
| FINITURA | BN   | NR   |
| IMBALLO  | 12   | 12   |
| EURO     | 7,10 | 7,10 |



### art. 3.2470

portabito tondo

|          |    |    |
|----------|----|----|
| FINITURA | BN | NR |
| IMBALLO  | 12 | 12 |



### art. 3.2475

portabito Arco

|          |    |    |
|----------|----|----|
| FINITURA | BN | NR |
| IMBALLO  | 12 | 12 |



### art. 3.2866

coppia nottolini wc Q6  
con rosetta ø 50 mm a pressione

|          |    |    |
|----------|----|----|
| FINITURA | BN | NR |
| IMBALLO  | 10 | 10 |

Linea Serie **LINEA HOTEL**

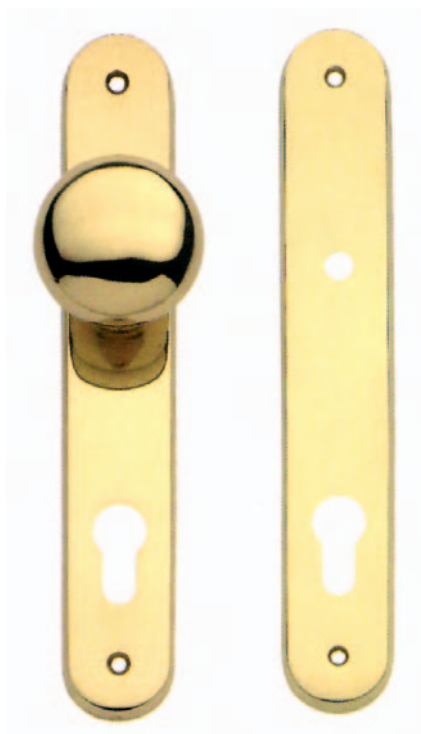

**art. CHV 1.01801**

GRT ingresso universale  
con placca stretta 230x38 mm

|          |     |
|----------|-----|
| FINITURA | OLV |
| IMBALLO  | 1   |

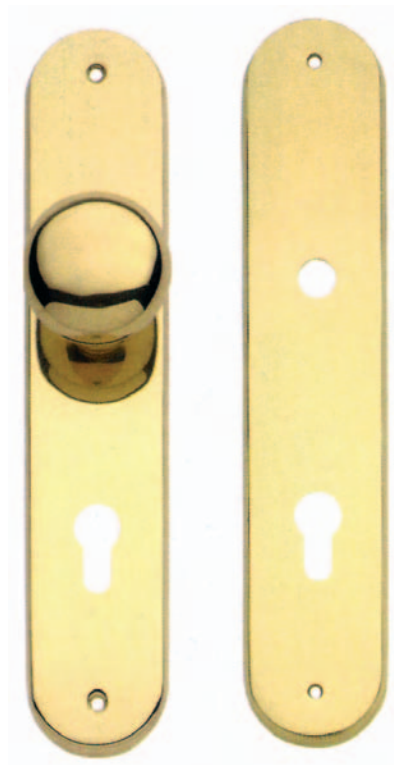

**art. CHV 3.01801**

GRT ingresso universale  
con placca 278x56 mm

|          |     |
|----------|-----|
| FINITURA | OLV |
| IMBALLO  | 4   |

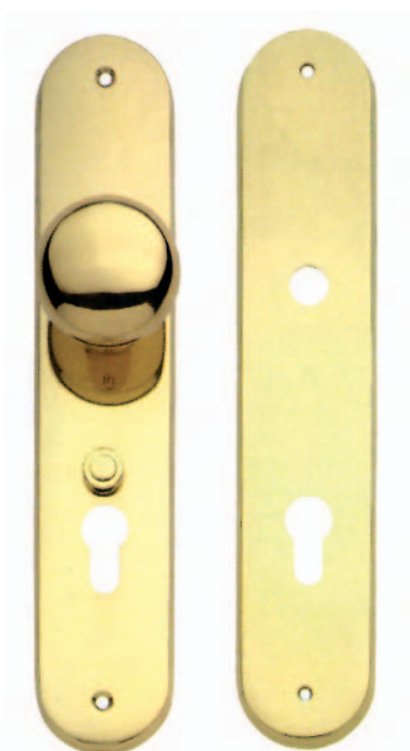

**art. CHV 3.01801 VC**

GRT ingresso con visualizzatore di presenza per  
sistema tipo CISA con placca stretta 278x56 mm

**art. CHV 3.01801 VY**

GRT ingresso con visualizzatore di presenza per  
sistema tipo YALE con placca 278x56 mm

|          |     |
|----------|-----|
| FINITURA | OLV |
| IMBALLO  | 1   |

AL PREZZO INDICATO VA AGGIUNTO IL COSTO DEL MODELLO DELLA MANIGLIA SCELTA



**art. 4.1120.70**

mini martellina Vega  
con rosetta ovale e vita a vista  
int. 43 mm

|          |     |     |     |
|----------|-----|-----|-----|
| FINITURA | OLV | OGR | CRS |
| IMBALLO  | 6   | 6   | 6   |



**art. 4.1320.70**

mini martellina Altwien  
con rosetta ovale e vita a vista  
int. 43 mm

|          |     |     |     |
|----------|-----|-----|-----|
| FINITURA | OLV | OGR | CRS |
| IMBALLO  | 6   | 6   | 6   |



**art. 4.6720.70**

mini martellina Elegant  
con rosetta ovale e vita a vista  
int. 43 mm

|          |     |     |     |
|----------|-----|-----|-----|
| FINITURA | OLV | OGR | CRS |
| IMBALLO  | 6   | 6   | 6   |



**art. 4.0110**

martellina universale  
con rosetta ovale e vita a vista  
int. 43 mm

|          |     |     |     |
|----------|-----|-----|-----|
| FINITURA | OLV | OGR | ANT |
| IMBALLO  | 6   | 6   | 6   |



**art. 4.2263.70**

martellina Alice  
con rosetta ovale e vita a vista  
int. 43 mm

|          |     |     |     |
|----------|-----|-----|-----|
| FINITURA | OLV | OGR | CRS |
| IMBALLO  | 6   | 6   | 6   |



**art. 4.2663.70**

martellina Praga  
con rosetta ovale e vita a vista  
int. 43 mm

|          |     |     |     |
|----------|-----|-----|-----|
| FINITURA | OLV | OGR | CRS |
| IMBALLO  | 6   | 6   | 6   |



**art. 4.2963.70**

martellina Venezia  
con rosetta ovale e vita a vista  
int. 43 mm

| FINITURA | OLV | OGR | CRS |
|----------|-----|-----|-----|
| IMBALLO  | 6   | 6   | 6   |



**art. 4.3363.70**

martellina Malaga  
con rosetta ovale e vita a vista  
int. 43 mm

| FINITURA | OLV | OGR | CRS |
|----------|-----|-----|-----|
| IMBALLO  | 6   | 6   | 6   |



**art. 4.6063.70**

martellina Gemma  
con rosetta ovale e vita a vista  
int. 43 mm

| FINITURA | OLV | OGR | CRS |
|----------|-----|-----|-----|
| IMBALLO  | 6   | 6   | 6   |



**art. 4.6163.70**

martellina Lara  
con rosetta ovale e vita a vista  
int. 43 mm

| FINITURA | OLV | OGR | CRS |
|----------|-----|-----|-----|
| IMBALLO  | 6   | 6   | 6   |



**art. 4.6363.70**

martellina Eva  
con rosetta ovale e vita a vista  
int. 43 mm

| FINITURA | OLV | OGR | CRS |
|----------|-----|-----|-----|
| IMBALLO  | 6   | 6   | 6   |



**art. 4.8463.70**

martellina Miriam  
con rosetta ovale e vita a vista  
int. 43 mm

| FINITURA | OLV | OGR | CRS |
|----------|-----|-----|-----|
| IMBALLO  | 6   | 6   | 6   |



**art. 4.8763.70**

martellina Drò  
con rosetta ovale e vita a vista  
int. 43 mm

| FINITURA | OLV  | OGR   | CRS   |
|----------|------|-------|-------|
| IMBALLO  | 6    | 6     | 6     |
| EURO     | 9,00 | 10,00 | 12,00 |



**art. 4.1120**

segretino Vega  
con rosetta ovale e vita a vista -  $\varnothing$  7 mm

|          |     |     |     |
|----------|-----|-----|-----|
| FINITURA | OLV | OGR | CRS |
| IMBALLO  | 6   | 6   | 6   |



**art. 4.1320**

segretino Altwien  
con rosetta ovale e vita a vista -  $\varnothing$  7 mm

|          |     |     |     |
|----------|-----|-----|-----|
| FINITURA | OLV | OGR | CRS |
| IMBALLO  | 6   | 6   | 6   |



**art. 4.6720**

segretino Elegant  
con rosetta ovale e vita a vista -  $\varnothing$  7 mm

|          |     |     |     |
|----------|-----|-----|-----|
| FINITURA | OLV | OGR | CRS |
| IMBALLO  | 6   | 6   | 6   |



# BOCCHETTE



## art. 2.9025

bocchetta artistica  
ø 45 mm - viti in vista con foro chiave

| FINITURA | OLV  | ANT  | ARG  | ANT  | CR |
|----------|------|------|------|------|----|
| IMBALLO  | 30   | 30   | 30   | 30   | 30 |
| EURO     | 3,20 | 3,60 | 5,00 | 4,50 |    |



## art. 2.9025.18

bocchetta artistica  
ø 50 mm - viti in vista con foro cilindro

| FINITURA | OLV  | ANT  | ARG  | ANT  | CR   | CRS |
|----------|------|------|------|------|------|-----|
| IMBALLO  | 10   | 10   | 10   | 10   | 10   | 10  |
| EURO     | 6,30 | 7,10 | 9,10 | 7,60 | 7,60 |     |

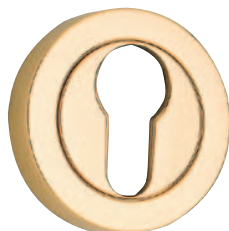

## art. 2.9030.18

bocchetta coprivite  
ø 50 mm ad avvitare con foro cilindro

## art. 2.9030

bocchetta coprivite  
ø 50 mm ad avvitare con foro asola

| FINITURA | OLV | OGR | ANT | CR | CRS |
|----------|-----|-----|-----|----|-----|
| IMBALLO  | 10  | 10  | 10  | 10 | 10  |



## art. 2.9030.32

bocchetta coprivite  
ø 50 mm ad avvitare senza foro

| FINITURA | OLV | OGR | ANT | CR | CRS |
|----------|-----|-----|-----|----|-----|
| IMBALLO  | 10  | 10  | 10  | 10 | 10  |



## art. 2.9035.18

bocchetta coprivite  
ø 45 mm a pressione con foro cilindro

## art. 2.9035

bocchetta coprivite  
ø 45 mm a pressione con foro asola

| FINITURA | OLV | OGR | ANT | CR | CRS |
|----------|-----|-----|-----|----|-----|
| IMBALLO  | 10  | 10  | 10  | 10 | 10  |



## art. 2.9040.18

bocchetta coprivite ovale  
62x30 mm con foro cilindro

## art. 2.9040

bocchetta coprivite ovale  
62x30 mm con foro asola

| FINITURA | OLV | OGR | SAT | CR | CRS |
|----------|-----|-----|-----|----|-----|
| IMBALLO  | 10  | 10  | 10  | 10 | 10  |



**art. 2.9045**

bocchetta lux  
ø 45 mm ad avvitare con foro asola

|          |     |     |     |
|----------|-----|-----|-----|
| FINITURA | OLV | ANT | CRS |
| IMBALLO  | 10  | 10  | 10  |



**art. 2.9070.18**

bocchetta coprivite bombata  
ø 50 mm ad avvitare con foro cilindro

**art. 2.9070**

bocchetta coprivite bombata  
ø 50 mm ad avvitare con foro asola

|          |     |     |     |    |     |
|----------|-----|-----|-----|----|-----|
| FINITURA | OLV | OGR | ANT | CR | CRS |
| IMBALLO  | 10  | 10  | 10  | 10 | 10  |



**art. 2.9080**

bocchetta liscia  
ø 32 mm con viti in vista - foro asola

|          |     |
|----------|-----|
| FINITURA | OLV |
| IMBALLO  | 30  |



**art. 2.9085**

bocchetta decorata  
ø 32 mm con viti in vista - foro asola

|          |     |
|----------|-----|
| FINITURA | OLV |
| IMBALLO  | 30  |



**art. 2.9130.18**

bocchetta coprivite in fibra  
ø 50 mm a pressione con foro cilindro

**art. 2.9130**

bocchetta coprivite in fibra  
ø 50 mm a pressione con foro asola

|          |      |      |
|----------|------|------|
| FINITURA | BN   | NR   |
| IMBALLO  | 30   | 30   |
| EURO     | 1,60 | 1,60 |



**art. 2.9150.18**

bocchetta coprivate  
 ø 50 mm a pressione con foro cilindro

**art. 2.9150**

bocchetta coprivate  
 ø 50 mm a pressione con foro asola

|          |          |
|----------|----------|
| FINITURA | ACC. SAT |
| IMBALLO  | 12       |



**art. 2.9155.18**

bocchetta coprivate ovale  
 62x30 mm a pressione con foro cilindro

**art. 2.9155**

bocchetta coprivate ovale  
 62x30 mm a pressione con foro asola

|          |          |
|----------|----------|
| FINITURA | ACC. SAT |
| IMBALLO  | 25       |



**art. 2.9180.18**

bocchetta coprivate con bordo  
 ø 50 mm ad avvitare con foro cilindro

**art. 2.9180**

bocchetta coprivate con bordo  
 ø 50 mm ad avvitare con foro asola

|          |     |     |         |
|----------|-----|-----|---------|
| FINITURA | OLV | OGR | ORO ANT |
| IMBALLO  | 10  | 10  | 10      |



**art. 2.9160.18**

bocchetta coprivate tonda  
 ø 50 mm con viti in vista e foro cilindro

|          |          |
|----------|----------|
| FINITURA | FERRO NR |
| IMBALLO  | 20       |



**art. 2.9170.18**

bocchetta tonda  
 ø 50 mm a pressione con foro yale

**art. 2.9170**

bocchetta coprivate  
 ø 50 mm a pressione con foro asola

|          |         |          |
|----------|---------|----------|
| FINITURA | ALL. BZ | ALL. ARG |
| IMBALLO  | 30      | 30       |



**art. 2.9200.18**

bocchetta quadra  
 50x50 mm con foro cilindro

**art. 2.9200**

bocchetta quadra  
 50x50 mm con foro asola

|          |     |     |     |
|----------|-----|-----|-----|
| FINITURA | OLV | OGR | CRS |
| IMBALLO  | 10  | 10  | 10  |

# serie COPPIA NOTTOLINI WC



## art. 3.2850

coppia nottolino wc con rosetta  
 ø 50 mm ad avvitare con imp. pesante

|          |     |     |     |
|----------|-----|-----|-----|
| FINITURA | OLV | ANT | CRS |
| IMBALLO  | 5   | 5   | 5   |



## art. 3.2860

coppia nottolino wc  
 con rosetta ø 50 mm ad avvitare

|          |     |     |     |
|----------|-----|-----|-----|
| FINITURA | OLV | ANT | CRS |
| IMBALLO  | 5   | 5   | 5   |



## art. 3.2861

coppia nottolino wc  
 con rosetta ø 45 mm a pressione

|          |     |     |     |
|----------|-----|-----|-----|
| FINITURA | OLV | ANT | CRS |
| IMBALLO  | 5   | 5   | 5   |



## art. 3.2866

coppia nottolino wc  
 con rosetta ø 50 mm a pressione

|          |    |    |
|----------|----|----|
| FINITURA | BN | NR |
| IMBALLO  | 10 | 10 |



## art. 3.2870

coppia nottolino wc  
 con rosetta ø 50 mm a pressione

|          |          |
|----------|----------|
| FINITURA | ACC. SAT |
| IMBALLO  | 5        |



## art. 3.2872

coppia nottolino wc  
 con rosetta ø 32 mm ad avvitare

|          |     |     |     |
|----------|-----|-----|-----|
| FINITURA | OLV | ANT | CRS |
| IMBALLO  | 5   | 5   | 5   |



## art. 3.2873

coppia nottolino wc  
 con rosetta quadra 50x50 mm

|          |     |     |     |
|----------|-----|-----|-----|
| FINITURA | OLV | OGR | CRS |
| IMBALLO  | 2   | 2   | 2   |



sinSeries

# MANIGLIE A INCASSO



## art. 7.5100

kit nicchia tonda "wc"  
compresa serratura e maniglietta di trascinamento

| FINITURA | OLV | ANT | CR | CRS |
|----------|-----|-----|----|-----|
| IMBALLO  | 1   | 1   | 1  | 1   |



## art. 7.5110

kit nicchia tonda "foro chiave"  
compresa serratura e maniglietta di trascinamento

| FINITURA | OLV | ANT | CR | CRS |
|----------|-----|-----|----|-----|
| IMBALLO  | 1   | 1   | 1  | 1   |



**art. 7.5200**

kit nicchia ovale coprivite con sottoplastica "wc"  
compresa serratura e maniglietta di trascinamento

| FINITURA | OLV | OGR | CR | CRS |
|----------|-----|-----|----|-----|
| IMBALLO  | 1   | 1   | 1  | 1   |



**art. 7.5210**

kit nicchia ovale coprivite con sottoplastica "foro chiave"  
compresa serratura e maniglietta di trascinamento

| FINITURA | OLV | OGR | CR | CRS |
|----------|-----|-----|----|-----|
| IMBALLO  | 1   | 1   | 1  | 1   |

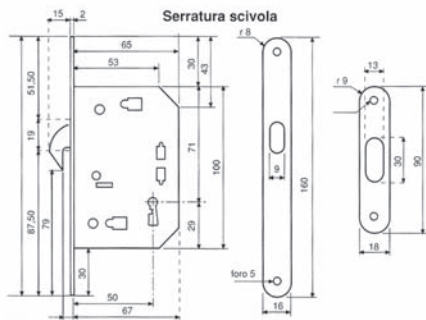
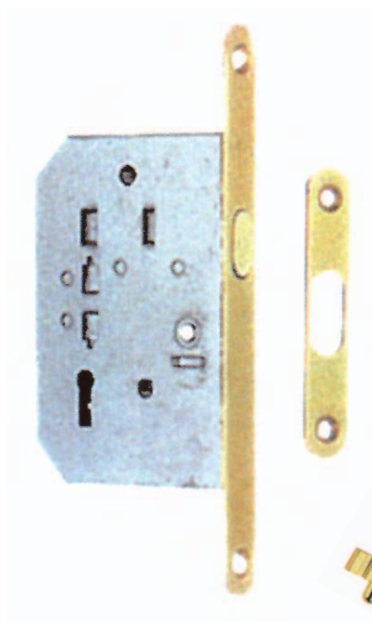

**art. 7.5040**

serratura per scorrevoli "foro chiave"

|          |     |     |    |     |
|----------|-----|-----|----|-----|
| FINITURA | OLV | ANT | CR | CRS |
| IMBALLO  | 2   | 2   | 2  | 2   |

**art. 7.5050**

serratura per scorrevoli "wc"

|          |     |     |    |     |
|----------|-----|-----|----|-----|
| FINITURA | OLV | ANT | CR | CRS |
| IMBALLO  | 2   | 2   | 2  | 2   |

**art. 7.5060**

piastra copriserratura per porte scorrevoli

|          |     |    |    |     |
|----------|-----|----|----|-----|
| FINITURA | OLV | BR | CR | CRS |
| IMBALLO  | 50  | 50 | 50 | 50  |



**art. 3.2701**

maniglia ad incasso tonda  
senza foro chiave

|          |            |            |            |            |
|----------|------------|------------|------------|------------|
| MISURA   | ø 26X12 mm | ø 30X12 mm | ø 35X12 mm | ø 40X12 mm |
| FINITURA | OLV        | OLV        | OLV        | OLV        |
| IMBALLO  | 20         | 20         | 20         | 20         |

|          |     |     |     |     |
|----------|-----|-----|-----|-----|
| FINITURA | OGR | OGR | OGR | OGR |
|----------|-----|-----|-----|-----|

|          |    |    |    |    |
|----------|----|----|----|----|
| FINITURA | CR | CR | CR | CR |
|----------|----|----|----|----|

|          |     |     |     |     |
|----------|-----|-----|-----|-----|
| FINITURA | CRS | CRS | CRS | CRS |
|----------|-----|-----|-----|-----|

**art. 3.2702**

maniglia ad incasso tonda  
ø 57x12 mm - int. 44 mm con foro chiave

**art. 3.2703**

maniglia ad incasso tonda  
ø 57x12 mm - int. 44 mm senza foro

**art. 3.2704**

maniglia ad incasso tonda  
ø 57x12 mm - int. 44 mm con foro yale

|          |     |     |    |     |
|----------|-----|-----|----|-----|
| FINITURA | OLV | OGR | CR | CRS |
| IMBALLO  | 24  | 24  | 24 | 24  |



**art. 3.2710**

nicchia tonda  
 ø 57x12 mm - int. 44 mm semichiusa

|          |     |     |     |    |     |
|----------|-----|-----|-----|----|-----|
| FINITURA | OLV | OGR | SAT | CR | CRS |
| IMBALLO  | 24  | 24  | 24  | 24 | 24  |



**art. 3.2720**

maniglia ad incasso quadra  
 52x52 h.12 mm - int. 44x10 mm senza foro

|          |     |     |     |    |     |
|----------|-----|-----|-----|----|-----|
| FINITURA | OLV | OGR | SAT | CR | CRS |
| IMBALLO  | 12  | 12  | 12  | 12 | 12  |



**art. 3.2750**

coppia maniglia ad incasso tonda  
 ø 57x12 mm - int. 44 mm con nottolino wc

|          |     |     |    |     |
|----------|-----|-----|----|-----|
| FINITURA | OLV | OGR | CR | CRS |
| IMBALLO  | 6   | 6   | 6  | 6   |



**art. 3.2770**

coppia maniglia ad incasso tonda  
 ø 57x12 mm - int. 44 mm con pendente e gettone

|          |     |     |     |    |     |
|----------|-----|-----|-----|----|-----|
| FINITURA | OLV | OGR | SAT | CR | CRS |
| IMBALLO  | 4   | 4   | 4   | 4  | 4   |



**art. 3.2771**

coppia maniglia ad incasso tonda  
 ø 57x12 mm - int. 44 mm con doppio pendente

|          |     |     |     |    |     |
|----------|-----|-----|-----|----|-----|
| FINITURA | OLV | OGR | SAT | CR | CRS |
| IMBALLO  | 4   | 4   | 4   | 4  | 4   |



**art. 3.2802**

maniglia ad incasso ovale con sottoplastica  
 152x37 mm - int. 117x22 mm con foro chiave decentrato

**art. 3.2803**

maniglia ad incasso ovale con sottoplastica  
 152x37 mm - int. 117x22 mm senza foro chiave

|          |     |     |    |     |
|----------|-----|-----|----|-----|
| FINITURA | OLV | OGR | CR | CRS |
| IMBALLO  | 24  | 24  | 24 | 24  |



**art. 3.2812**

maniglia ad incasso ovale con sottoplastica  
125x40 mm - int. 80x24 mm con foro chiave centrale

**art. 3.2813**

maniglia ad incasso ovale con sottoplastica  
125x40 mm - int. 80x24 mm senza foro chiave

| FINITURA | OLV | OGR | CR | CRS |
|----------|-----|-----|----|-----|
| IMBALLO  | 24  | 24  | 24 | 24  |



**art. 3.2900**

maniglia ad incasso rettangolare  
120x40 mm con foro chiave centrale

**art. 3.2901**

maniglia ad incasso rettangolare  
120x40 mm senza foro chiave

| FINITURA | OLV | OGR | CR | CRS |
|----------|-----|-----|----|-----|
| IMBALLO  | 12  | 12  | 12 | 12  |



**art. 3.2950**

maniglia per porte scorrevoli  
158x37 mm da appoggio

| FINITURA | OLV | OGR | CR | CRS |
|----------|-----|-----|----|-----|
| IMBALLO  | 12  | 12  | 12 | 12  |



**art. 3.2960**

maniglia ad incasso ovale Elisse  
220x33 mm con foro chiave centrale

**art. 3.2961**

maniglia ad incasso ovale Elisse  
220x33 mm senza foro chiave

| FINITURA | OLV | OGR | CR | CRS |
|----------|-----|-----|----|-----|
| IMBALLO  | 12  | 12  | 12 | 12  |

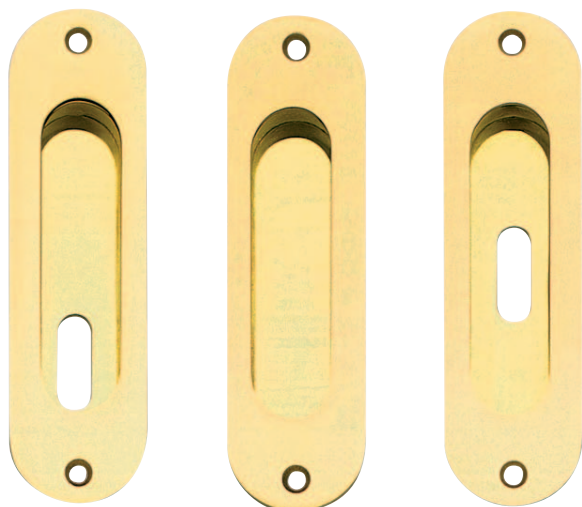

**art. 3.2970**

maniglia ad incasso ovale  
120X33 mm - int. 75x20 mm con foro chiave decentrato

**art. 3.2971**

maniglia ad incasso ovale  
120X33 mm - int. 75x20 mm senza foro chiave

**art. 3.2972**

maniglia ad incasso ovale  
120X33 mm - int. 75x20 mm senza foro chiave centrale

|          |     |     |    |     |
|----------|-----|-----|----|-----|
| FINITURA | OLV | OGR | CR | CRS |
| IMBALLO  | 25  | 25  | 25 | 25  |



**art. 3.2980**

maniglia ad incasso  
50X40 mm

|          |     |     |    |     |
|----------|-----|-----|----|-----|
| FINITURA | OLV | OGR | CR | CRS |
| IMBALLO  | 25  | 25  | 25 | 25  |



**art. 3.2990**

maniglia di trascinamento ditale  
ø 25x20 mm

|          |     |     |    |     |
|----------|-----|-----|----|-----|
| FINITURA | OLV | OGR | CR | CRS |
| IMBALLO  | 25  | 25  | 25 | 25  |



**art. 3.2985**

maniglia ad incasso  
ø 58 mm

|          |     |
|----------|-----|
| FINITURA | OLV |
| IMBALLO  | 25  |

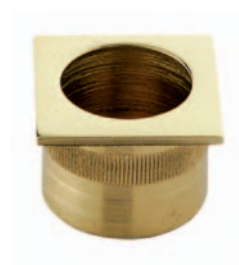

**art. 3.2993**

maniglia di trascinamento ditale quadrata  
ø 25 - 27x27 mm

|          |     |     |    |     |
|----------|-----|-----|----|-----|
| FINITURA | OLV | OGR | CR | CRS |
| IMBALLO  | 25  | 25  | 25 | 25  |

# SET PER PORTE BLINDATE



## art. CPB 2.1910

set per porte blindate composto da:  
 A - pomolo Omega ø 60 mm  
 C/D - acc. fissaggio  
 B - rosetta ø 50 mm a pressione  
 E - impugnatura Omega  
 F - rosetta ø 50 mm a pressione  
 G - ferro espansione 8x80 mm

| FINITURA | ALL. BR | ALL. ARG |
|----------|---------|----------|
| IMBALLO  | 1       | 1        |



## art. CPB 1.6470

set per porte blindate composto da:  
 A - pomolo Omega ø 60 mm  
 C/D - acc. fissaggio  
 B - rosetta ø 50 mm a pressione  
 E - impugnatura Thea  
 F - rosetta ø 50 mm a pressione  
 G - ferro espansione 8x80 mm

| FINITURA | ALL. BR | ALL. ARG |
|----------|---------|----------|
| IMBALLO  | 1       | 1        |



**art. CPB 1.6468**

set per porte blindate composto da:  
 A - pomolo Omega ø 60 mm  
 B - rosetta ø 50 mm a pressione  
 C - impugnatura Thea  
 D - ferro fisso  
 nypless 8x100 mm

|          |         |          |
|----------|---------|----------|
| FINITURA | ALL. BR | ALL. ARG |
| IMBALLO  | 6       | 6        |



**art. CPB 1.9561**

set per porte blindate composto da:  
 A - pomolo Victoria ø 55 mm  
 B - rosetta ø 45 mm a pressione  
 C - impugnatura Karol  
 D - ferro fisso  
 nypless 8x100 mm

|          |     |     |     |
|----------|-----|-----|-----|
| FINITURA | OLV | OGR | CRS |
| IMBALLO  | 1   | 1   | 1   |



**art. 2.9006**

bocchetta  
57x70 mm per chiave doppia mappa

|          |     |     |     |
|----------|-----|-----|-----|
| FINITURA | OLV | OGR | CRS |
| IMBALLO  | 10  | 10  | 10  |



**art. 2.9006.18**

bocchetta  
57x70 mm per foro yale

|          |     |     |     |
|----------|-----|-----|-----|
| FINITURA | OLV | OGR | CRS |
| IMBALLO  | 10  | 10  | 10  |



**art. 2.9007**

bocchetta  
57x70 mm per limitatore

|          |     |     |     |
|----------|-----|-----|-----|
| FINITURA | OLV | OGR | CRS |
| IMBALLO  | 10  | 10  | 10  |



**art. 2.9008.01**

bocchetta  
57x70 mm per chiave doppia mappa con copriforo

|          |     |     |     |
|----------|-----|-----|-----|
| FINITURA | OLV | OGR | CRS |
| IMBALLO  | 10  | 10  | 10  |

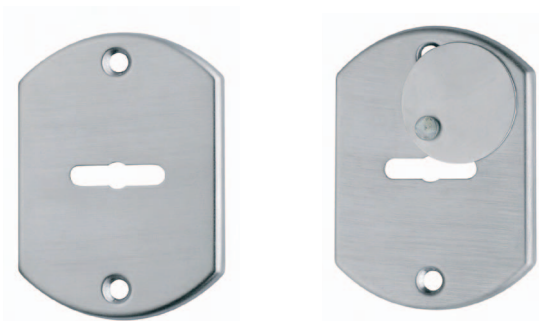

**art. 2.9008**

coppia bocchetta  
57x70 mm per chiave, doppia mappa con copriforo

|          |     |     |     |
|----------|-----|-----|-----|
| FINITURA | OLV | OGR | CRS |
| IMBALLO  | 10  | 10  | 10  |



**art. 2.9010**

bocchetta coprivite con sottoplastica  
 ø 45 mm per chiave, doppia mappa

| FINITURA | OLV | OGR | SAT | CR | CRS |
|----------|-----|-----|-----|----|-----|
| IMBALLO  | 30  | 30  | 30  | 30 | 30  |

**art. 2.9012**

coppia bocchetta coprivite con sottoplastica  
 ø 45 mm per chiave, doppia mappa con copriforo

| FINITURA | OLV | OGR | CRS |
|----------|-----|-----|-----|
| IMBALLO  | 10  | 10  | 10  |



**art. 2.9020**

bocchetta rettangolare  
 50x36 mm per chiave, doppia mappa

| FINITURA | OLV | OGR | SAT | CR | CRS |
|----------|-----|-----|-----|----|-----|
| IMBALLO  | 10  | 10  | 10  | 10 | 10  |

**art. 2.9022**

coppia bocchetta rettangolare  
 50x63 mm per chiave, doppia mappa con copriforo

| FINITURA | OLV | OGR | CRS |
|----------|-----|-----|-----|
| IMBALLO  | 10  | 10  | 10  |



**art. 2.9020.18**

bocchetta rettangolare  
 50x36 mm per foro cilindro

| FINITURA | OLV | OGR | SAT | CR | CRS |
|----------|-----|-----|-----|----|-----|
| IMBALLO  | 10  | 10  | 10  | 10 | 10  |

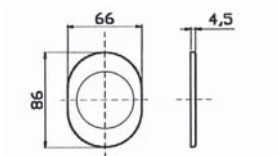

art. 5.4330

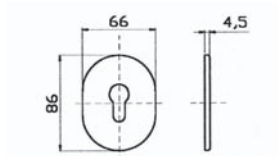

art. 5.4332

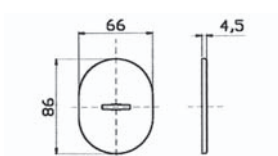

art. 5.4331

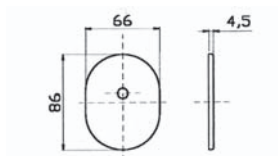

art. 5.4333

**art. 5.4330**

mostrina ovale coprivite per defender  
66x86 mm con sottoplastica a pressione

**art. 5.4331**

mostrina ovale coprivite doppia mappa  
66x86 mm con sottoplastica a pressione

**art. 5.4332**

mostrina ovale coprivite foro yale  
66x86 mm con sottoplastica a pressione

**art. 5.4333**

mostrina ovale coprivite foro per pomello cilindro  
66x86 mm con sottoplastica a pressione

|          |         |          |
|----------|---------|----------|
| FINITURA | ALL. BR | ALL. ARG |
| IMBALLO  | 10      | 10       |

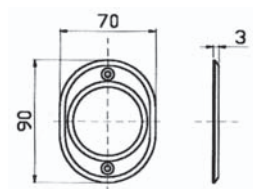

art. 5.4340

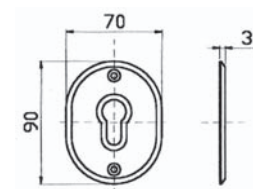

art. 5.4342

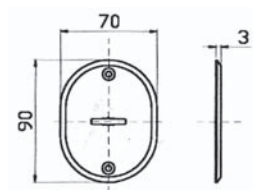

art. 5.4341



art. 5.4343

**art. 5.4340**

mostrina ovale coprivite per defender  
70x90 mm con sottoplastica a pressione  
e con viti in vista

**art. 5.4341**

mostrina ovale coprivite doppia mappa  
70x90 mm con sottoplastica a pressione  
e con viti in vista

**art. 5.4342**

mostrina ovale coprivite foro yale  
70x90 mm con sottoplastica a pressione  
e con viti in vista

**art. 5.4343**

mostrina ovale coprivite foro per pomello cilindro  
70x90 mm con sottoplastica a pressione  
e con viti in vista

|          |     |     |     |
|----------|-----|-----|-----|
| FINITURA | OLV | OLV | OLV |
| IMBALLO  | 10  | 10  | 10  |



**art. 6.0150**

nottolino sicurezza  
con rosetta tonda e viti in vista

| FINITURA | OLV | OGR | CRS |
|----------|-----|-----|-----|
| IMBALLO  | 20  | 20  | 20  |



**art. 6.0151**

nottolino sicurezza  
con rosetta ovale e viti in vista

| FINITURA | OLV | OGR | CRS |
|----------|-----|-----|-----|
| IMBALLO  | 20  | 20  | 20  |



**art. 6.0153**

nottolino sicurezza  
con rosetta ovale a pressione

| FINITURA | OLV | OGR | CRS | ALL. BR |
|----------|-----|-----|-----|---------|
| IMBALLO  | 20  | 20  | 20  | 20      |



**art. 6.0156**

nottolino sicurezza  
con rosetta ø 50 mm a pressione

| FINITURA | OLV | OGR | CRS | ALL. BR |
|----------|-----|-----|-----|---------|
| IMBALLO  | 20  | 20  | 20  | 20      |



**art. 3.2000**

pomolo Gemini ø 43 mm  
rosetta ø 45 mm a pressione - ferro espansione 55 mm

| FINITURA | OLV | SAT | CRS |
|----------|-----|-----|-----|
| IMBALLO  | 6   | 6   | 6   |

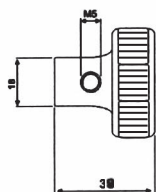

**art. 6.0130**

pomello per cilindro  
ø 38 mm - foro 8 mm

| FINITURA | OLV | OGR | CRS |
|----------|-----|-----|-----|
| IMBALLO  | 10  | 10  | 10  |

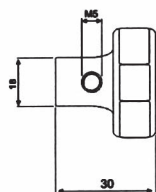

**art. 6.0135**

pomello per cilindro  
ø 30 mm - foro 8 mm

| FINITURA | OLV   | OGR   | CRS   |
|----------|-------|-------|-------|
| IMBALLO  | 10    | 10    | 10    |
| EURO     | 12,00 | 13,00 | 14,00 |

# serie POMOLI ACCOPPIATI



## art. I.1092

coppia pomolo Victorian  
con rosetta e bocchetta con viti in vista senza molla

|          |     |     |     |
|----------|-----|-----|-----|
| FINITURA | OLV | OGR | CRS |
| IMBALLO  | 1   | 1   | 1   |

## art. I.1095

coppia pomolo Victorian  
con rosetta e bocchetta Lux ø 45 mm ad avvitare

|          |     |     |     |
|----------|-----|-----|-----|
| FINITURA | OLV | OGR | CRS |
| IMBALLO  | 1   | 1   | 1   |



## art. I.4660

coppia pomolo Urano decentrato  
con rosetta e bocchetta ø 50 mm ad avvitare

|          |     |
|----------|-----|
| FINITURA | OLV |
| IMBALLO  | 1   |

## art. I.4663

coppia pomolo Urano decentrato  
con rosetta e bocchetta ovale

|          |     |
|----------|-----|
| FINITURA | OLV |
| IMBALLO  | 1   |



## art. I.9096

coppia pomolo Diamante ø 60 mm  
con rosetta senza bocchetta

|          |       |       |
|----------|-------|-------|
| FINITURA | OLV   | OGR   |
| IMBALLO  | 1     | 1     |
| EURO     | 50,20 | 51,50 |



**art. I.9116**

coppia pomolo Sfera ø 60 mm  
con rosetta senza bocchetta

|          |     |
|----------|-----|
| FINITURA | OLV |
| IMBALLO  | 1   |



**art. I.9200**

coppia pomolo Urano ø 60 mm  
con rosetta senza bocchetta

|          |     |
|----------|-----|
| FINITURA | OLV |
| IMBALLO  | 1   |

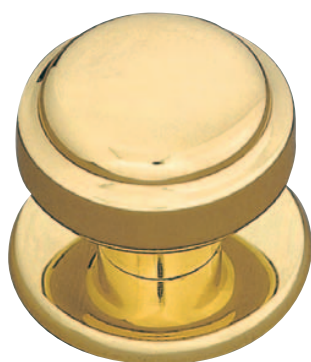

**art. I.9210**

coppia pomolo Nettuno ø 60 mm  
con rosetta senza bocchetta

|          |     |
|----------|-----|
| FINITURA | OLV |
| IMBALLO  | 1   |



**art. I.6585**

coppia pomolo Giulia con rosetta  
e bocchetta Lux ad avvitare in porcellana bianca

|          |         |         |
|----------|---------|---------|
| FINITURA | PBN/OLV | PBN/ANT |
| IMBALLO  | 1       | 1       |

**art. 1.3072**

coppia pomolo tondo Alba con rosetta e bocchetta  
con viti in vista senza molla in porcellana bianca decorata

**art. 1.3082**

coppia pomolo ovale Alba con rosetta e bocchetta  
con viti in vista senza molla in porcellana bianca decorata

| FINITURA | PBND/OLV | PBND/ANT |
|----------|----------|----------|
| IMBALLO  | 1        | 1        |

**art. 1.3075**

coppia pomolo tondo Alba con rosetta  
e bocchetta Lux ad avvitare in porcellana bianca decorata

**art. 1.3085**

coppia pomolo ovale Alba con rosetta  
e bocchetta Lux ad avvitare in porcellana bianca decorata

| FINITURA | PBND/OLV | PBND/ANT |
|----------|----------|----------|
| IMBALLO  | 1        | 1        |

**art. 1.3972**

coppia pomolo tondo con rosetta e bocchetta  
con viti in vista senza molla in porcellana bianca

**art. 1.3982**

coppia pomolo ovale con rosetta e bocchetta  
con viti in vista senza molla in porcellana bianca

| FINITURA | PBN/OLV | PBN/ANT |
|----------|---------|---------|
| IMBALLO  | 1       | 1       |

**art. 1.3975**

coppia pomolo tondo con rosetta  
e bocchetta Lux ad avvitare in porcellana bianca

**art. 1.3985**

coppia pomolo ovale con rosetta  
e bocchetta Lux ad avvitare in porcellana bianca

| FINITURA | PBN/OLV | PBN/ANT |
|----------|---------|---------|
| IMBALLO  | 1       | 1       |

**art. 1.5572**

coppia pomolo tondo con rosetta e bocchetta  
con viti in vista senza molla in porcellana bianca c/ fiore blu

**art. 1.5582**

coppia pomolo ovale con rosetta e bocchetta  
con viti in vista senza molla in porcellana bianca c/ fiore blu

| FINITURA | PBN F. BLU/OLV | PBN F. BLU/ANT |
|----------|----------------|----------------|
| IMBALLO  | 1              | 1              |

**art. 1.5575**

coppia pomolo tondo con rosetta  
e bocchetta Lux ad avvitare in porcellana bianca c/ fiore blu

**art. 1.5585**

coppia pomolo ovale con rosetta  
e bocchetta Lux ad avvitare in porcellana bianca c/ fiore blu

| FINITURA | PBN F. BLU/OLV | PBN F. BLU/ANT |
|----------|----------------|----------------|
| IMBALLO  | 1              | 1              |

**art. I.6072**

coppia pomolo tondo Gemma con rosetta e bocchetta  
con viti in vista senza molla in porcellana champagne decorata

**art. I.6082**

coppia pomolo ovale Gemma con rosetta e bocchetta  
con viti in vista senza molla in porcellana champagne decorata

| FINITURA | PCHD/OLV | PCHD/ANT |
|----------|----------|----------|
| IMBALLO  | 1        | 1        |

**art. I.6075**

coppia pomolo tondo Gemma con rosetta  
e bocchetta Lux ad avvitare in porcellana champagne decorata

**art. I.6085**

coppia pomolo ovale Gemma con rosetta  
e bocchetta Lux ad avvitare in porcellana champagne decorata

| FINITURA | PCHD/OLV | PCHD/ANT |
|----------|----------|----------|
| IMBALLO  | 1        | 1        |

**art. I.6172**

coppia pomolo tondo con rosetta e bocchetta  
con viti in vista senza molla in porcellana champagne

**art. I.6182**

coppia pomolo ovale con rosetta e bocchetta  
con viti in vista senza molla in porcellana champagne

| FINITURA | PCH/OLV | PCH/ANT |
|----------|---------|---------|
| IMBALLO  | 1       | 1       |

**art. I.6175**

coppia pomolo tondo con rosetta  
e bocchetta Lux ad avvitare in porcellana champagne

**art. I.6185**

coppia pomolo ovale con rosetta  
e bocchetta Lux ad avvitare in porcellana champagne

| FINITURA | PCH/OLV | PCH/ANT |
|----------|---------|---------|
| IMBALLO  | 1       | 1       |

**art. I.6272**

coppia pomolo tondo Anna con rosetta e bocchetta  
con viti in vista senza molla in porcellana bianca decorata

**art. I.6282**

coppia pomolo ovale Anna con rosetta e bocchetta  
con viti in vista senza molla in porcellana bianca decorata

| FINITURA | PBND/OLV | PBND/ANT |
|----------|----------|----------|
| IMBALLO  | 1        | 1        |

**art. I.6275**

coppia pomolo tondo Anna con rosetta  
e bocchetta Lux ad avvitare in porcellana bianca decorata

**art. I.6285**

coppia pomolo ovale Anna con rosetta  
e bocchetta Lux ad avvitare in porcellana bianca decorata

| FINITURA | PBND/OLV | PBND/ANT |
|----------|----------|----------|
| IMBALLO  | 1        | 1        |

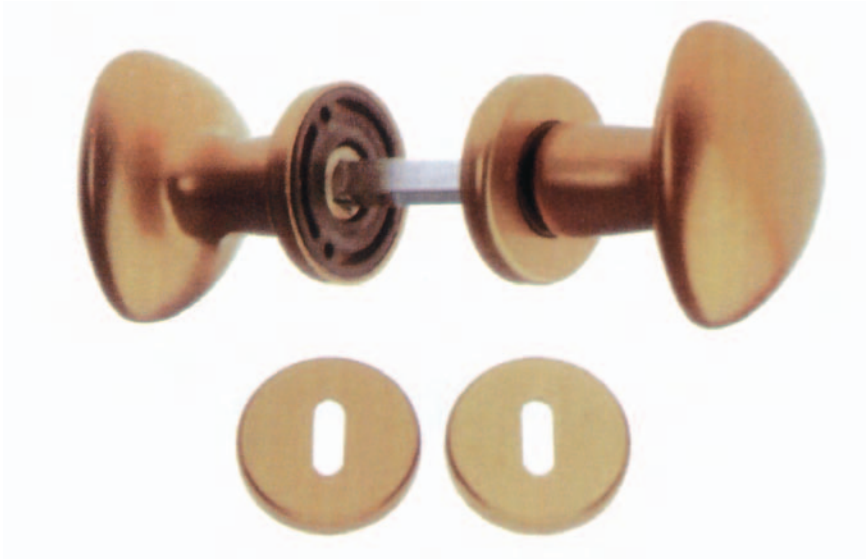

**art. 1.9130**

guarnitura Triangolo **alluminio**  
rosetta e bocchetta ø 50 mm a pressione

| FINITURA | ALL. BR | ALL. ARG |
|----------|---------|----------|
| IMBALLO  | 4       | 4        |

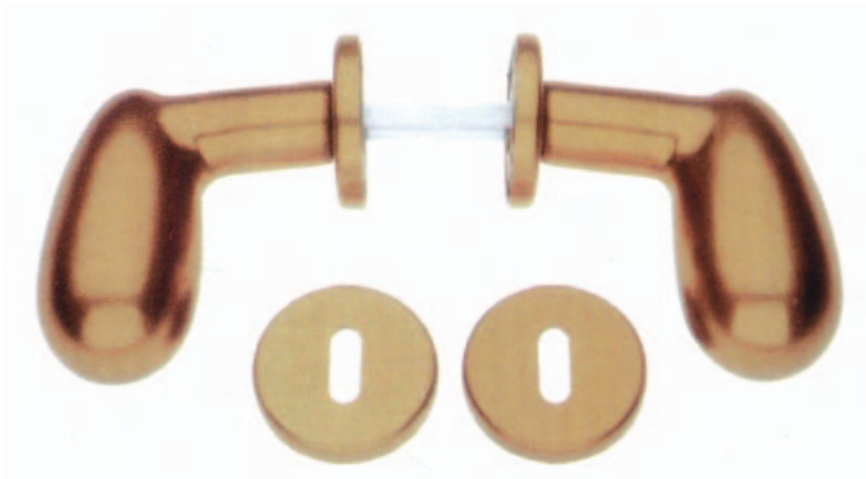

**art. 1.9140**

guarnitura Uovo **alluminio**  
rosetta e bocchetta ø 50 mm a pressione

| FINITURA | ALL. BR | ALL. ARG |
|----------|---------|----------|
| IMBALLO  | 4       | 4        |

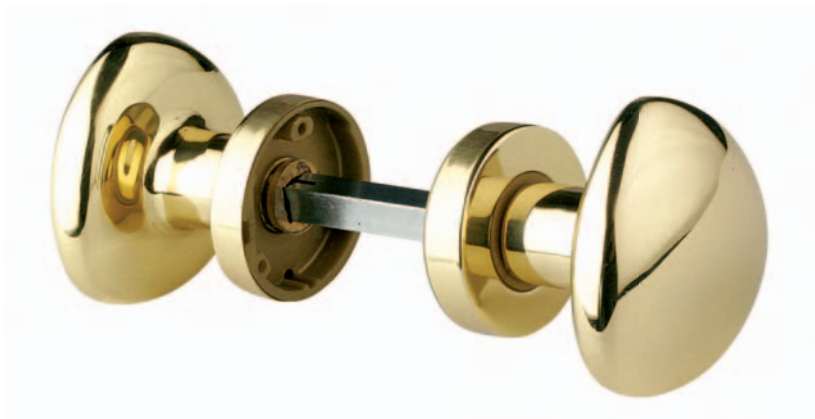

**art. 1.9130**

guarnitura Triangolo **ottone**  
rosetta e bocchetta ø 45 mm a pressione

| FINITURA | OLV | SAT | CRS |
|----------|-----|-----|-----|
| IMBALLO  | 2   | 2   | 2   |



# Serie POMOLI FISSI



## art. 3.2030

pomolo Ares ø 65 mm  
base 56 mm con sottorosone e esagono

|          |     |     |     |     |
|----------|-----|-----|-----|-----|
| FINITURA | OLV | OGR | CRS | PVD |
| IMBALLO  | 2   | 2   | 2   | 2   |



## art. 3.2090

pomolo Zeus ø 74 mm  
base 56 mm con sottorosone e esagono

|          |     |     |     |     |
|----------|-----|-----|-----|-----|
| FINITURA | OLV | OGR | CRS | PVD |
| IMBALLO  | 2   | 2   | 2   | 2   |



## art. 3.2170.07

pomolo Elite  
ø 70 mm con perno passante

|          |     |     |     |
|----------|-----|-----|-----|
| FINITURA | OLV | OGR | CRS |
| IMBALLO  | 10  | 10  | 10  |

## art. 3.2170.17

pomolo Elite  
ø 70 mm con sottorosone

|          |     |     |     |
|----------|-----|-----|-----|
| FINITURA | OLV | OGR | CRS |
| IMBALLO  | 10  | 10  | 10  |



**art. 3.0006.07**

pomolo Georgian  
ø 70 mm con perno passante

|          |     |     |
|----------|-----|-----|
| FINITURA | OLV | OGR |
| IMBALLO  | 6   | 6   |



**art. 3.0033**

pomolo Ringo  
ø 60 mm con perno passante

|          |     |     |
|----------|-----|-----|
| FINITURA | OLV | OGR |
| IMBALLO  | 15  | 15  |



**art. 3.0096.06**

pomolo Diamante  
ø 60 mm con perno passante

|          |     |     |
|----------|-----|-----|
| FINITURA | OLV | OGR |
| IMBALLO  | 8   | 8   |

**art. 3.0096.07**

pomolo Diamante  
ø 70 mm con perno passante

|          |     |     |
|----------|-----|-----|
| FINITURA | OLV | OGR |
| IMBALLO  | 6   | 6   |

**art. 3.0096.08**

pomolo Diamante  
ø 80 mm con perno passante

|          |     |     |
|----------|-----|-----|
| FINITURA | OLV | OGR |
| IMBALLO  | 2   | 2   |



**art. 3.0106.07**

pomolo Victorian  
 ø 70 mm con perno passante

|          |     |     |  |
|----------|-----|-----|--|
| FINITURA | OLV | OGR |  |
| IMBALLO  | 2   | 2   |  |



**art. 3.0109**

pomolo Classic  
 ø 70 mm con perno passante

|          |     |     |     |
|----------|-----|-----|-----|
| FINITURA | OLV | OGR | CRS |
| IMBALLO  | 6   | 6   | 6   |

**art. 3.0109.17**

pomolo Classic  
 ø 70 mm con sottorosone

|          |     |     |     |
|----------|-----|-----|-----|
| FINITURA | OLV | OGR | CRS |
| IMBALLO  | 6   | 6   | 6   |



**art. 3.0110**

pomolo ottagonale  
 ø 70 mm con perno passante

|          |      |
|----------|------|
| FINITURA | FUMÈ |
| IMBALLO  | 6    |



### art. 3.0116.06

pomolo sfera  
 ø 60 mm con perno passante

|          |     |     |     |
|----------|-----|-----|-----|
| FINITURA | OLV | OGR | CRS |
| IMBALLO  | 8   | 8   | 8   |

### art. 3.0116.07

pomolo sfera  
 ø 70 mm con perno passante

|          |     |     |     |
|----------|-----|-----|-----|
| FINITURA | OLV | OGR | CRS |
| IMBALLO  | 6   | 6   | 6   |

### art. 3.0116.08

pomolo sfera  
 ø 80 mm con perno passante

|          |     |     |     |
|----------|-----|-----|-----|
| FINITURA | OLV | OGR | CRS |
| IMBALLO  | 2   | 2   | 2   |



### art. 3.2001

pomolo Gemini ø 64 mm  
 con rosetta ø 45 mm a pressione e sottorosone

|          |     |     |     |
|----------|-----|-----|-----|
| FINITURA | OLV | SAT | CRS |
| IMBALLO  | 6   | 6   | 6   |



### art. 3.2010

pomolo Drop  
 ø 70 mm con perno passante

|          |     |
|----------|-----|
| FINITURA | OLV |
| IMBALLO  | 6   |



**art. 3.2055**

pomolo Cris  
 ø 78 mm con perno passante

|          |     |     |
|----------|-----|-----|
| FINITURA | OLV | ANT |
| IMBALLO  | 6   | 6   |



**art. 3.2060**

pomolo Zara ø 65 mm  
 base ø 56 mm con sottorosone e esagono

|          |     |     |     |
|----------|-----|-----|-----|
| FINITURA | OLV | OGR | CRS |
| IMBALLO  | 2   | 2   | 2   |



**art. 3.2080**

pomolo Dora ø 65 mm  
 base ø 56 mm con sottorosone e esagono

|          |     |     |     |
|----------|-----|-----|-----|
| FINITURA | OLV | OGR | CRS |
| IMBALLO  | 2   | 2   | 2   |

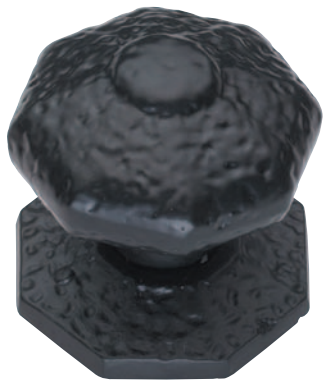

**art. 3.2110**

pomolo ottagonale  
ø 62 mm

|          |          |
|----------|----------|
| FINITURA | FERRO NR |
| IMBALLO  | 2        |



**art. 3.2120**

pomolo Denz  
ø 65 mm

|          |          |
|----------|----------|
| FINITURA | FERRO NR |
| IMBALLO  | 2        |



**art. 3.2130**

pomolo Spagna ø 72 mm  
base ø 84 mm con perno passante

|          |     |    |
|----------|-----|----|
| FINITURA | OLV | CR |
| IMBALLO  | 2   | 2  |



**art. 3.2140**

pomolo Giglio  
ø 70 mm con perno passante

|          |      |
|----------|------|
| FINITURA | BR   |
| IMBALLO  | 12   |
| EURO     | 9,90 |



**art. 3.2150**

pomolo Luna  
ø 70 mm con perno passante

|          |    |
|----------|----|
| FINITURA | BR |
| IMBALLO  | 12 |



**art. 3.2160**

pomolo Sole  
ø 70 mm con perno passante

|          |    |
|----------|----|
| FINITURA | BR |
| IMBALLO  | 12 |



### art. 3.2180.07

pomolo Blindo  
ø 70 mm con perno passante

|          |     |     |
|----------|-----|-----|
| FINITURA | OLV | OGR |
| IMBALLO  | 10  | 10  |

### art. 3.2180.17

pomolo Blindo  
ø 70 mm con sottorosone

|          |     |     |
|----------|-----|-----|
| FINITURA | OLV | OGR |
| IMBALLO  | 10  | 10  |



### art. 3.2190

pomolo concavo  
ø 70 mm con perno passante

|          |     |     |
|----------|-----|-----|
| FINITURA | OLV | OGR |
| IMBALLO  | 12  | 12  |



### art. 3.2200.06

pomolo Urano  
ø 60 mm con perno passante

|          |     |
|----------|-----|
| FINITURA | OLV |
| IMBALLO  | 8   |

### art. 3.2200.07

pomolo Urano  
ø 70 mm con perno passante

|          |     |
|----------|-----|
| FINITURA | OLV |
| IMBALLO  | 6   |

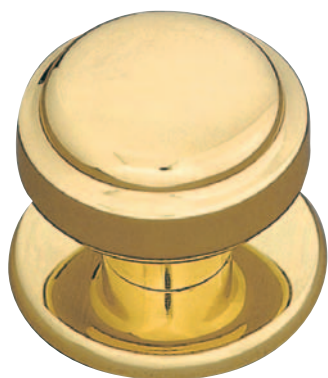

**art. 3.2210.06**

pomolo Nettuno  
ø 60 mm con perno passante

|          |     |
|----------|-----|
| FINITURA | OLV |
| IMBALLO  | 8   |

**art. 3.2210.07**

pomolo Nettuno  
ø 70 mm con perno passante

|          |     |
|----------|-----|
| FINITURA | OLV |
| IMBALLO  | 6   |



**art. 3.2230.06**

pomolo Plutone  
ø 60 mm con perno passante

|          |     |
|----------|-----|
| FINITURA | OLV |
| IMBALLO  | 8   |

**art. 3.2230.07**

pomolo Plutone  
ø 70 mm con perno passante

|          |     |
|----------|-----|
| FINITURA | OLV |
| IMBALLO  | 6   |



**art. 3.2240.06**

pomolo Mercurio  
ø 60 mm con perno passante

|          |     |
|----------|-----|
| FINITURA | OLV |
| IMBALLO  | 8   |

**art. 3.2240.07**

pomolo Mercurio  
ø 70 mm con perno passante

|          |     |
|----------|-----|
| FINITURA | OLV |
| IMBALLO  | 6   |



**art. 3.2250.07**

pomolo Margherita ø 70 mm  
base ø 80 mm con perno passante

|          |     |     |
|----------|-----|-----|
| FINITURA | OLV | OGR |
| IMBALLO  | 6   | 6   |

**art. 3.2250.08**

pomolo Margherita ø 80 mm  
base ø 80 mm con perno passante

|          |     |     |
|----------|-----|-----|
| FINITURA | OLV | OGR |
| IMBALLO  | 4   | 4   |



**art. 3.2260**

pomolo Ottagonale  
ø 85 mm con perno passante o sottorosone

|          |     |     |
|----------|-----|-----|
| FINITURA | OLV | ANT |
| IMBALLO  | 2   | 2   |



**art. 3.2270**

pomolo Onda  
ø 95 mm con perno passante o sottorosone

|          |     |
|----------|-----|
| FINITURA | OLV |
| IMBALLO  | 2   |



**art. 3.2280**

pomolo Base sagomata  $\varnothing$  70 mm  
base  $\varnothing$  77 mm con perno passante

|          |     |     |
|----------|-----|-----|
| FINITURA | OLV | OGR |
| IMBALLO  | 8   | 8   |



**art. 3.2290**

pomolo Leo con rosetta  $\varnothing$  50 mm ad avvitare  
con ferro nyplés

|          |     |     |     |
|----------|-----|-----|-----|
| FINITURA | OLV | OGR | CRS |
| IMBALLO  | 2   | 2   | 2   |



**art. 3.2420**

pomolo Madrid  $\varnothing$  70 mm  
base  $\varnothing$  80 mm con perno passante

|          |     |     |
|----------|-----|-----|
| FINITURA | OLV | OGR |
| IMBALLO  | 6   | 6   |



**art. 3.6400**

pomolo Thea **alluminio**  
 ø 70 mm fisso con sottorosone

| FINITURA | ALL. BR | ALL. ARG |
|----------|---------|----------|
| IMBALLO  | 10      | 10       |



**art. 3.6450**

pomolo Omega **alluminio**  
 ø 60 mm fisso con sottorosone

| FINITURA | ALL. BR | ALL. ARG |
|----------|---------|----------|
| IMBALLO  | 10      | 10       |



**art. 3.6500**

pomolo Triangolo **alluminio**  
 fisso con sottorosone - rosetta ø 50 mm a pressione

| FINITURA | ALL. BR | ALL. ARG |
|----------|---------|----------|
| IMBALLO  | 10      | 10       |



**art. 3.6500**

pomolo Triangolo **ottone**  
 fisso con sottorosone - rosetta ø 50 mm a pressione

| FINITURA | OLV   | SAT   | CRS   |
|----------|-------|-------|-------|
| IMBALLO  | 4     | 4     | 4     |
| EURO     | 17,00 | 18,00 | 19,00 |



**art. 7.4620.37**

pomolo caposcala h. 69 mm

|          |                |
|----------|----------------|
| MISURA   | ø 37 fil 10 MA |
| FINITURA | OLV            |
| IMBALLO  | 6              |



**art. 7.4620.48**

pomolo caposcala h. 88 mm

|          |                |
|----------|----------------|
| MISURA   | ø 48 fil 10 MA |
| FINITURA | OLV            |
| IMBALLO  | 4              |



**art. 7.4620.55**

pomolo caposcala h. 103 mm

|          |                |
|----------|----------------|
| MISURA   | ø 55 fil 10 MA |
| FINITURA | OLV            |
| IMBALLO  | 4              |



**art. 7.4670**

pomolo caposcala liscio

|          |               |               |                |
|----------|---------------|---------------|----------------|
| MISURA   | ø 25 fil 8 MA | ø 30 fil 8 MA | ø 40 fil 10 MA |
| FINITURA | OL            | OL            | OL             |
| IMBALLO  | 30            | 30            | 24             |

|          |                |                |                |
|----------|----------------|----------------|----------------|
| MISURA   | ø 50 fil 10 MA | ø 60 fil 12 MA | ø 70 fil 14 MA |
| FINITURA | OL             | OL             | OL             |
| IMBALLO  | 6              | 5              | 5              |



**art. 7.4680**

pomolo caposcala con fascia

|          |               |               |                |                |
|----------|---------------|---------------|----------------|----------------|
| MISURA   | ø 20 fil 8 MA | ø 25 fil 8 MA | ø 30 fil 10 MA | ø 35 fil 10 MA |
| FINITURA | TORNITO       | TORNITO       | TORNITO        | TORNITO        |
| IMBALLO  | 50            | 30            | 30             | 24             |

|          |                |                |                |                |                |
|----------|----------------|----------------|----------------|----------------|----------------|
| MISURA   | ø 40 fil 10 MA | ø 45 fil 10 MA | ø 50 fil 10 MA | ø 60 fil 12 MA | ø 70 fil 14 MA |
| FINITURA | TORNITO        | TORNITO        | TORNITO        | TORNITO        | TORNITO        |
| IMBALLO  | 30             | 24             | 6              | 5              | 5              |

# Serie POMOLINI VETRO MURANO



## art. 3.8200

pomolino liscio in vetro scavo di murano ø 27 mm

|          |            |          |         |
|----------|------------|----------|---------|
| FINITURA | BIANCO/ORO | ROSA/ORO | BLU/ORO |
| IMBALLO  | 12         | 12       | 12      |

|          |           |           |
|----------|-----------|-----------|
| FINITURA | VERDE/ORO | AMBRA/ORO |
| IMBALLO  | 12        | 12        |

## art. 3.8250

pomolino rigato in vetro scavo di murano ø 27 mm

|          |            |          |         |
|----------|------------|----------|---------|
| FINITURA | BIANCO/ORO | ROSA/ORO | BLU/ORO |
| IMBALLO  | 12         | 12       | 12      |

|          |           |           |
|----------|-----------|-----------|
| FINITURA | VERDE/ORO | AMBRA/ORO |
| IMBALLO  | 12        | 12        |

# Serie POMOLINI VERSILIA



## art. 3.8300

pomolino a funghetto in marmo ø 25 mm

|          |        |      |       |
|----------|--------|------|-------|
| FINITURA | BIANCO | ROSA | VERDE |
| IMBALLO  | 24     | 24   | 24    |

|          |       |      |            |
|----------|-------|------|------------|
| FINITURA | ROSSO | NERO | TRAVERTINO |
| IMBALLO  | 24    | 24   | 24         |

## art. 3.8350

pomolino a sfera in marmo ø 25 mm

|          |        |      |       |
|----------|--------|------|-------|
| FINITURA | BIANCO | ROSA | VERDE |
| IMBALLO  | 24     | 24   | 24    |

|          |       |      |            |
|----------|-------|------|------------|
| FINITURA | ROSSO | NERO | TRAVERTINO |
| IMBALLO  | 24    | 24   | 24         |

# serie POMOLINI PORCELLANA



## art. 3.8000

pomolino tondo senza base

|          |                 |                 |
|----------|-----------------|-----------------|
| MISURA   | ø 26 - h. 24 mm | ø 30 - h. 25 mm |
| FINITURA | PBN             | PBN             |
| IMBALLO  | 50              | 50              |



## art. 3.8001

pomolino tondo senza base

|          |                 |
|----------|-----------------|
| MISURA   | ø 30 - h. 25 mm |
| FINITURA | PBLU            |
| IMBALLO  | 50              |



## art. 3.8002

pomolino tondo senza base

|          |                 |
|----------|-----------------|
| MISURA   | ø 30 - h. 25 mm |
| FINITURA | PVERDE          |
| IMBALLO  | 50              |



## art. 3.8003

pomolino tondo senza base

|          |                 |                 |
|----------|-----------------|-----------------|
| MISURA   | ø 26 - h. 24 mm | ø 30 - h. 25 mm |
| FINITURA | PCH             | PCH             |
| IMBALLO  | 50              | 50              |



## art. 3.8006

pomolino tondo senza base

|          |                 |                 |
|----------|-----------------|-----------------|
| MISURA   | ø 26 - h. 24 mm | ø 30 - h. 25 mm |
| FINITURA | PBN F. MARRONE  | PBN F. MARRONE  |
| IMBALLO  | 50              | 50              |



## art. 3.8007

pomolino tondo senza base

|          |                 |                 |
|----------|-----------------|-----------------|
| MISURA   | ø 26 - h. 24 mm | ø 30 - h. 25 mm |
| FINITURA | PCH IBISCO      | PCH IBISCO      |
| IMBALLO  | 50              | 50              |



## art. 3.8008

pomolino tondo senza base

|          |                 |                 |
|----------|-----------------|-----------------|
| MISURA   | ø 26 - h. 24 mm | ø 30 - h. 25 mm |
| FINITURA | PBN IBISCO      | PBN IBISCO      |
| IMBALLO  | 50              | 50              |



## art. 3.8010

pomolino tondo senza base

|          |                 |                 |
|----------|-----------------|-----------------|
| MISURA   | ø 26 - h. 24 mm | ø 30 - h. 25 mm |
| FINITURA | PBN C/FIORE     | PBN C/FIORE     |
| IMBALLO  | 50              | 50              |

**art. 3.8011**

pomolino tondo senza base

|          |                 |
|----------|-----------------|
| MISURA   | ø 30 - h. 25 mm |
| FINITURA | PBN F. BLU      |
| IMBALLO  | 50              |

**art. 3.8013**

pomolino tondo senza base

|          |                 |
|----------|-----------------|
| MISURA   | ø 30 - h. 25 mm |
| FINITURA | PCH C/FIORE     |
| IMBALLO  | 50              |

**art. 3.8015**

pomolino tondo senza base

|          |                 |
|----------|-----------------|
| MISURA   | ø 30 - h. 25 mm |
| FINITURA | PBN F. ROSA     |
| IMBALLO  | 50              |

**art. 3.8020**

pomolino tondo senza base

|          |                 |
|----------|-----------------|
| MISURA   | ø 30 - h. 25 mm |
| FINITURA | PBN RIGA ORO    |
| IMBALLO  | 50              |

**art. 3.8023**

pomolino tondo senza base

|          |                 |
|----------|-----------------|
| MISURA   | ø 30 - h. 25 mm |
| FINITURA | PCH F. CAMPO    |
| IMBALLO  | 50              |

**art. 3.8025**

pomolino tondo senza base

|          |                 |
|----------|-----------------|
| MISURA   | ø 30 - h. 25 mm |
| FINITURA | PNR             |
| IMBALLO  | 50              |

**art. 3.8030**

pomolino ovale senza base

|          |                  |
|----------|------------------|
| MISURA   | 33x24 - h. 26 mm |
| FINITURA | PBN              |
| IMBALLO  | 50               |

**art. 3.8031**

pomolino ovale senza base

|          |                  |
|----------|------------------|
| MISURA   | 33x24 - h. 26 mm |
| FINITURA | PBLU             |
| IMBALLO  | 50               |

**art. 3.8032**

pomolino ovale senza base

|          |                  |
|----------|------------------|
| MISURA   | 33x24 - h. 26 mm |
| FINITURA | PVERDE           |
| IMBALLO  | 50               |

**art. 3.8033**

pomolino ovale senza base

|          |                  |
|----------|------------------|
| MISURA   | 33x24 - h. 26 mm |
| FINITURA | PCH              |
| IMBALLO  | 50               |

**art. 3.8040**

pomolino ovale senza base

|          |                  |
|----------|------------------|
| MISURA   | 33x24 - h. 26 mm |
| FINITURA | PBN C/FIORE      |
| IMBALLO  | 50               |

**art. 3.8041**

pomolino ovale senza base

|          |                  |
|----------|------------------|
| MISURA   | 33x24 - h. 26 mm |
| FINITURA | PBN F. BLU       |
| IMBALLO  | 50               |

**art. 3.8043**

pomolino ovale senza base

|          |                  |
|----------|------------------|
| MISURA   | 33X24 - h. 26 mm |
| FINITURA | PCH C/FIORE      |
| IMBALLO  | 50               |

**art. 3.8044**

pomolino ovale senza base

|          |                  |
|----------|------------------|
| MISURA   | 33X24 - h. 26 mm |
| FINITURA | PBN IBISCO       |
| IMBALLO  | 50               |

**art. 3.8046**

pomolino ovale senza base

|          |                  |
|----------|------------------|
| MISURA   | 33X24 - h. 26 mm |
| FINITURA | PBN MIOSOTIS     |
| IMBALLO  | 50               |

**art. 3.8047**

pomolino ovale senza base

|          |                  |
|----------|------------------|
| MISURA   | 33X24 - h. 26 mm |
| FINITURA | PBN DEC. BLU     |
| IMBALLO  | 50               |

**art. 3.8048**

pomolino ovale senza base

|          |                  |
|----------|------------------|
| MISURA   | 33x24 - h. 26 mm |
| FINITURA | PCH IBISCO       |
| IMBALLO  | 50               |

**art. 3.8049**

pomolino ovale senza base

|          |                  |
|----------|------------------|
| MISURA   | 33x24 - h. 26 mm |
| FINITURA | PBN F. MARRONE   |
| IMBALLO  | 50               |



**art. 3.8050**

pomolino rettangolare BN senza base

|          |                  |
|----------|------------------|
| MISURA   | 25X30 - h. 18 mm |
| FINITURA | PBN C/RIGA       |
| IMBALLO  | 25               |



**art. 3.8060**

pomolino goccia senza base

|          |                 |
|----------|-----------------|
| MISURA   | ø 26 - h. 36 mm |
| FINITURA | PBN             |
| IMBALLO  | 25              |



**art. 3.8065**

pomolino ovale senza base

|          |                 |
|----------|-----------------|
| MISURA   | ø 26 - h. 36 mm |
| FINITURA | PBN C/FIORE     |
| IMBALLO  | 25              |



**art. 3.8068**

pomolino ovale senza base

|          |                 |
|----------|-----------------|
| MISURA   | ø 26 - h. 36 mm |
| FINITURA | PBN F. BLU      |
| IMBALLO  | 25              |



**art. 3.8069**

pomolino goccia senza base

|          |                 |
|----------|-----------------|
| MISURA   | ø 26 - h. 36 mm |
| FINITURA | PCH C/FIORE     |
| IMBALLO  | 25              |



**art. 3.8070**

pomolino tondo senza base

|          |                 |
|----------|-----------------|
| MISURA   | ø 30 - h. 25 mm |
| FINITURA | PBN FRUTTA      |
| IMBALLO  | 50              |



**art. 3.8071**

pomolino tondo senza base

|          |                 |
|----------|-----------------|
| MISURA   | ø 30 - h. 25 mm |
| FINITURA | PBN LIMONE      |
| IMBALLO  | 50              |



**art. 3.8072**

pomolino tondo senza base

|          |                 |
|----------|-----------------|
| MISURA   | ø 30 - h. 25 mm |
| FINITURA | PBN PERE        |
| IMBALLO  | 50              |

**art. 3.8073**

pomolino tondo senza base

|          |                 |
|----------|-----------------|
| MISURA   | ø 30 - h. 25 mm |
| FINITURA | PBN MELA        |
| IMBALLO  | 50              |

**art. 3.8074**

pomolino tondo senza base

|          |                 |
|----------|-----------------|
| MISURA   | ø 30 - h. 25 mm |
| FINITURA | PBN UVA         |
| IMBALLO  | 50              |

**art. 3.8075**

pomolino tondo senza base

|          |                 |
|----------|-----------------|
| MISURA   | ø 30 - h. 25 mm |
| FINITURA | PBN BOSCO       |
| IMBALLO  | 50              |

**art. 3.8076**

pomolino tondo senza base

|          |                 |
|----------|-----------------|
| MISURA   | ø 30 - h. 25 mm |
| FINITURA | PBN MISTO       |
| IMBALLO  | 50              |

**art. 3.8078**

pomolino tondo senza base

|          |                 |
|----------|-----------------|
| MISURA   | ø 30 - h. 25 mm |
| FINITURA | PBN MELA VERDE  |
| IMBALLO  | 50              |

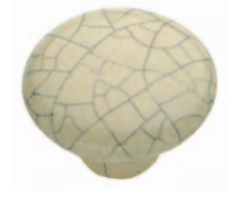
**art. 3.8083**

pomolino tondo senza base

|          |                 |                 |
|----------|-----------------|-----------------|
| MISURA   | ø 26 - h. 24 mm | ø 30 - h. 25 mm |
| FINITURA | PCH CRACKLÈ     | PCH CRACKLÈ     |
| IMBALLO  | 50              | 50              |

**art. 3.8080**

pomolino tondo senza base

|          |                 |
|----------|-----------------|
| MISURA   | ø 38 - h. 27 mm |
| FINITURA | PBN             |
| IMBALLO  | 50              |

**art. 3.8081**

pomolino tondo senza base

|          |                 |
|----------|-----------------|
| MISURA   | ø 38 - h. 27 mm |
| FINITURA | PCH             |
| IMBALLO  | 50              |

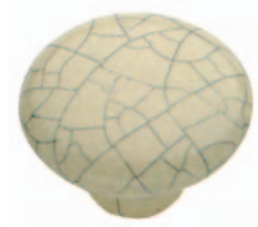
**art. 3.8082**

pomolino tondo senza base

|          |                 |
|----------|-----------------|
| MISURA   | ø 38 - h. 27 mm |
| FINITURA | PCH CRACKLÈ     |
| IMBALLO  | 50              |

**art. 3.8090**

pomolino ovale senza base

|          |                  |
|----------|------------------|
| MISURA   | 48x27 - h. 27 mm |
| FINITURA | PBN              |
| IMBALLO  | 50               |

**art. 3.8091**

pomolino ovale senza base

|          |                  |
|----------|------------------|
| MISURA   | 48x27 - h. 27 mm |
| FINITURA | PCH              |
| IMBALLO  | 50               |

**art. 3.8092**

pomolino ovale senza base

|          |                  |
|----------|------------------|
| MISURA   | 48x27 - h. 27 mm |
| FINITURA | PCH CRACKLÈ      |
| IMBALLO  | 50               |

**art. 3.8120.28**pomolino zucca  
ø 28 - h. 27 mm

|          |         |
|----------|---------|
| FINITURA | PBN/OLV |
| IMBALLO  | 50      |

**art. 3.8120.33**pomolino zucca  
ø 33 - h. 32 mm

|          |         |
|----------|---------|
| FINITURA | PBN/OLV |
| IMBALLO  | 50      |

**art. 2.9100**

bocchetta ø 31 mm

|          | 2.9100 | 2.9110      | 2.9120 |
|----------|--------|-------------|--------|
| FINITURA | PBN    | PBN C/FIORE | PCH    |
| IMBALLO  | 25     | 25          | 25     |

**art. 2.9900**base ø 18 mm  
per pomolini in porcellana

|          |    |     |     |
|----------|----|-----|-----|
| FINITURA | OL | NIK | ANT |
| IMBALLO  | 50 | 50  | 50  |

# PROMOZIONALE FINO AD ESAURIMENTO SCORTE



## art. 3.8130

pomolino Splendid

3.8130.25      3.8130.30

|          |                 |                 |
|----------|-----------------|-----------------|
| MISURA   | ø 25 - h. 27 mm | ø 30 - h. 32 mm |
| FINITURA | PBN/ORO         | PBN/ORO         |
| IMBALLO  | 50              | 50              |



BIANCO  
art. 3.8170



DECORATO  
art. 3.8171



CHAMPAGNE  
art. 3.8173



NERO  
art. 3.8177

## art. 3.8170

pomolino mignon con base OL

|          |                 |
|----------|-----------------|
| MISURA   | ø 18 - h. 24 mm |
| FINITURA | BN              |
| IMBALLO  | 50              |



BIANCO  
art. 3.8180



BLU  
art. 3.8181



VERDE  
art. 3.8182



CHAMPAGNE  
art. 3.8183



GIALLO  
art. 3.8184

## art. 3.8180

pomolino tondo con base OL

|          |                 |
|----------|-----------------|
| MISURA   | ø 25 - h. 32 mm |
| FINITURA | BN              |
| IMBALLO  | 25              |



## art. 3.8900

pomolino tondo senza base

|          |                 |                 |
|----------|-----------------|-----------------|
| MISURA   | ø 25 - h. 25 mm | ø 25 - h. 20 mm |
| FINITURA | PBN/OL          | PBN/ANT         |
| IMBALLO  | 50              | 50              |



## art. 3.8910

pomolino tondo senza base

|          |                 |                 |
|----------|-----------------|-----------------|
| MISURA   | ø 25 - h. 25 mm | ø 25 - h. 20 mm |
| FINITURA | P MARRONE/OL    | P MARRONE/ANT   |
| IMBALLO  | 50              | 50              |



## art. 3.8920

pomolino tondo senza base

|          |                 |                 |
|----------|-----------------|-----------------|
| MISURA   | ø 25 - h. 25 mm | ø 25 - h. 20 mm |
| FINITURA | PCH/OL          | PCH/ANT         |
| IMBALLO  | 50              | 50              |



## art. 3.9010

pomolino tondo senza base  
ø 36 - h. 23 mm

|          |     |
|----------|-----|
| FINITURA | PBN |
| IMBALLO  | 50  |



## art. 3.9020

pomolino tondo senza base  
ø 36 - h. 23 mm

|          |     |
|----------|-----|
| FINITURA | PBN |
| IMBALLO  | 50  |



**art. 3.8197**

maniglia ad anello  
ø 32 mm

|          |     |    |    |
|----------|-----|----|----|
| FINITURA | OLV | BR | CR |
| IMBALLO  | 25  | 25 | 25 |



**art. 3.8380**

pomolino Basket

|          |                 |
|----------|-----------------|
| MISURA   | ø 30 - h. 55 mm |
| FINITURA | FERRO NR        |
| IMBALLO  | 30              |



**art. 3.8540**

pomolino scalinato

|          |                 |
|----------|-----------------|
| MISURA   | ø 30 - h. 25 mm |
| FINITURA | OLV             |
| IMBALLO  | 25              |



**art. 3.8560**

pomolino margherita

|          |                 |
|----------|-----------------|
| MISURA   | ø 30 - h. 29 mm |
| FINITURA | OLV             |
| IMBALLO  | 25              |



**art. 3.8580**

pomolino ottone goccia

|          |                 |
|----------|-----------------|
| MISURA   | ø 14 - h. 22 mm |
| FINITURA | OLV             |
| IMBALLO  | 30              |



**art. 3.8600**

pomolino Zeta

|          |                 |                 |                 |
|----------|-----------------|-----------------|-----------------|
|          | <b>8.600.25</b> | <b>8.600.30</b> | <b>8.600.35</b> |
| MISURA   | ø 25 - h. 22 mm | ø 30 - h. 26 mm | ø 35 - h. 30 mm |
| FINITURA | Z. OTT          | Z. OTT          | Z. OTT          |
| IMBALLO  | 50              | 50              | 50              |

|          |       |       |       |
|----------|-------|-------|-------|
| FINITURA | Z. BR | Z. BR | Z. BR |
|----------|-------|-------|-------|



**art. 3.8700**

pomolino

|          |         |         |         |         |
|----------|---------|---------|---------|---------|
| MISURA   | ø 18 mm | ø 22 mm | ø 26 mm | ø 30 mm |
| FINITURA | OLV     | OLV     | OLV     | OLV     |
| IMBALLO  | 50      | 50      | 30      | 30      |



**art. 3.8705**

pomolino

|          |         |         |         |         |
|----------|---------|---------|---------|---------|
| MISURA   | ø 22 mm | ø 28 mm | ø 34 mm | ø 40 mm |
| FINITURA | OLV     | OLV     | OLV     | OLV     |
| IMBALLO  | 50      | 50      | 30      | 30      |



**art. 3.8710**

pomolino

|          |         |         |         |         |         |
|----------|---------|---------|---------|---------|---------|
| MISURA   | ø 15 mm | ø 20 mm | ø 25 mm | ø 30 mm | ø 35 mm |
| FINITURA | OLV     | OLV     | OLV     | OLV     | OLV     |
| IMBALLO  | 50      | 50      | 30      | 30      | 20      |

|          |     |     |     |     |     |
|----------|-----|-----|-----|-----|-----|
| FINITURA | CRS | CRS | CRS | CRS | CRS |
|----------|-----|-----|-----|-----|-----|



**art. 3.8715**

pomolino

|          |         |         |         |         |
|----------|---------|---------|---------|---------|
| MISURA   | ø 20 mm | ø 25 mm | ø 30 mm | ø 32 mm |
| FINITURA | OLV     | OLV     | OLV     | OLV     |
| IMBALLO  | 50      | 30      | 30      | 30      |

|          |     |     |     |     |
|----------|-----|-----|-----|-----|
| FINITURA | CRS | CRS | CRS | CRS |
|----------|-----|-----|-----|-----|



**art. 3.8720**

pomolino

|          |         |         |         |         |
|----------|---------|---------|---------|---------|
| MISURA   | ø 17 mm | ø 20 mm | ø 25 mm | ø 32 mm |
| FINITURA | OLV     | OLV     | OLV     | OLV     |
| IMBALLO  | 50      | 50      | 50      | 30      |



**art. 3.8725**

pomolino

|          |         |         |         |         |
|----------|---------|---------|---------|---------|
| MISURA   | ø 17 mm | ø 21 mm | ø 26 mm | ø 32 mm |
| FINITURA | OLV     | OLV     | OLV     | OLV     |
| IMBALLO  | 50      | 50      | 50      | 30      |

**art. 3.8730**

pomolino

|          |         |         |         |         |
|----------|---------|---------|---------|---------|
| MISURA   | ø 20 mm | ø 25 mm | ø 30 mm | ø 35 mm |
| FINITURA | OLV     | OLV     | OLV     | OLV     |
| IMBALLO  | 50      | 30      | 30      | 30      |

**art. 3.8733**

pomolino

|          |         |         |         |
|----------|---------|---------|---------|
| MISURA   | ø 25 mm | ø 30 mm | ø 35 mm |
| FINITURA | OLV     | OLV     | OLV     |
| IMBALLO  | 30      | 30      | 30      |

**art. 3.8740**

pomolino

|          |         |         |         |
|----------|---------|---------|---------|
| MISURA   | ø 14 mm | ø 18 mm | ø 22 mm |
| FINITURA | OLV     | OLV     | OLV     |
| IMBALLO  | 50      | 50      | 50      |

**art. 3.8745**

pomolino

|          |         |         |
|----------|---------|---------|
| MISURA   | ø 12 mm | ø 12 mm |
| FINITURA | OLV     | CRS     |
| IMBALLO  | 50      | 50      |

**art. 3.8750**

pomolino

|          |         |         |
|----------|---------|---------|
| MISURA   | ø 15 mm | ø 15 mm |
| FINITURA | OLV     | CRS     |
| IMBALLO  | 50      | 50      |

**art. 3.8755**

pomolino

|          |         |
|----------|---------|
| MISURA   | ø 17 mm |
| FINITURA | OLV     |
| IMBALLO  | 50      |



**art. 3.8760**

pomolino

|          |         |         |
|----------|---------|---------|
| MISURA   | ø 24 mm | ø 24 mm |
| FINITURA | OLV     | CRS     |
| IMBALLO  | 50      | 50      |



**art. 3.8765**

pomolino

|          |         |         |         |
|----------|---------|---------|---------|
| MISURA   | ø 20 mm | ø 25 mm | ø 30 mm |
| FINITURA | OLV     | OLV     | OLV     |
| IMBALLO  | 50      | 50      | 30      |



**art. 3.8770**

pomolino

|          |         |         |         |
|----------|---------|---------|---------|
| MISURA   | ø 25 mm | ø 32 mm | ø 38 mm |
| FINITURA | OLV     | OLV     | OLV     |
| IMBALLO  | 25      | 25      | 25      |



**art. 3.8775**

pomolino ovale in due pezzi

|          |         |         |         |
|----------|---------|---------|---------|
| MISURA   | ø 18 mm | ø 25 mm | ø 30 mm |
| FINITURA | OLV     | OLV     | OLV     |
| IMBALLO  | 50      | 30      | 30      |



**art. 3.8778**

pomolino

|          |         |         |         |         |
|----------|---------|---------|---------|---------|
| MISURA   | ø 16 mm | ø 20 mm | ø 25 mm | ø 30 mm |
| FINITURA | OLV     | OLV     | OLV     | OLV     |
| IMBALLO  | 50      | 50      | 50      | 30      |



**art. 3.8780**

pomolino

|          |         |         |
|----------|---------|---------|
| MISURA   | ø 25 mm | ø 30 mm |
| FINITURA | OLV     | OLV     |
| IMBALLO  | 50      | 50      |



**art. 3.8810**

pomolino rigato

|          |         |         |
|----------|---------|---------|
| MISURA   | ø 16 mm | ø 16 mm |
| FINITURA | Z. OTT  | Z. CR   |
| IMBALLO  | 50      | 50      |



**art. 3.8820**

pomolino corona

|          |         |
|----------|---------|
| MISURA   | ø 30 mm |
| FINITURA | Z. OTT  |
| IMBALLO  | 50      |



**art. 3.8830**

pomolino 800

|          |         |         |
|----------|---------|---------|
| MISURA   | ø 25 mm | ø 30 mm |
| FINITURA | Z. ANT  | Z. ANT  |
| IMBALLO  | 50      | 50      |

|          |            |            |
|----------|------------|------------|
| FINITURA | Z. ORO ANT | Z. ORO ANT |
|----------|------------|------------|

|          |            |            |
|----------|------------|------------|
| FINITURA | Z. ARG ANT | Z. ARG ANT |
|----------|------------|------------|



**art. 3.8850**

pomolino Fiore

|          |             |             |
|----------|-------------|-------------|
| MISURA   | 30x15x29 mm | 25x12x24 mm |
| FINITURA | ANT         | ANT         |
| IMBALLO  | 25          | 25          |



**art. 3.8870**

pomolino quadro

|          |             |             |
|----------|-------------|-------------|
| MISURA   | 30x18x24 mm | 25x16x20 mm |
| FINITURA | ANT         | ANT         |
| IMBALLO  | 25          | 25          |



**art. 3.9000**

pomolino

|          |         |         |
|----------|---------|---------|
| MISURA   | ø 30 mm | ø 30 mm |
| FINITURA | PBN/ANT | PBN/CRS |
| IMBALLO  | 25      | 25      |



**art. 3.9130**

pomolino

|          |         |         |
|----------|---------|---------|
| MISURA   | ø 26 mm | ø 30 mm |
| FINITURA | OLV     | OLV     |
| IMBALLO  | 50      | 50      |

|          |         |         |
|----------|---------|---------|
| MISURA   | ø 26 mm | ø 30 mm |
| FINITURA | CR      | CR      |

# serie PENDENTI PORCELLANA



## art. 3.8190

pendente snodato  
60x23 mm

|          |     |
|----------|-----|
| FINITURA | PBN |
| IMBALLO  | 25  |



## art. 3.8191

pendente snodato antico  
60x23 mm

|          |            |
|----------|------------|
| FINITURA | PCH IBISCO |
| IMBALLO  | 25         |



## art. 3.8192

pendente snodato antico  
60x23 mm

|          |            |
|----------|------------|
| FINITURA | PBN F. BLU |
| IMBALLO  | 25         |



## art. 3.8193

pendente snodato  
60x23 mm

|          |     |
|----------|-----|
| FINITURA | PCH |
| IMBALLO  | 25  |



## art. 3.8194

pendente snodato  
60x23 mm

|          |     |     |
|----------|-----|-----|
| FINITURA | OLV | ANT |
| IMBALLO  | 25  | 25  |



## art. 3.8195

pendente snodato  
60x23 mm

|          |             |
|----------|-------------|
| FINITURA | PBN C/FIORE |
| IMBALLO  | 25          |



## art. 3.8196

pendente snodato antico  
60x23 mm

|          |                |
|----------|----------------|
| FINITURA | PBN F. MARRONE |
| IMBALLO  | 25             |



## art. 3.8199

pendente snodato antico  
60x23 mm

|          |             |
|----------|-------------|
| FINITURA | PCH C/FIORE |
| IMBALLO  | 25          |



**art. 3.2600**

maniglia Extra

|          |            |
|----------|------------|
| MISURA   | imp. 74 mm |
| FINITURA | PBN/ANT    |
| IMBALLO  | 25         |



**art. 3.2600**

maniglia Extra

|          |            |
|----------|------------|
| MISURA   | imp. 74 mm |
| FINITURA | PBN/CRS    |
| IMBALLO  | 25         |



**art. 3.2601**

maniglia Extra anticata

|          |                |
|----------|----------------|
| MISURA   | imp. 74 mm     |
| FINITURA | PBN MELA VERDE |
| IMBALLO  | 25             |



**art. 3.2602**

maniglia Extra anticata

|          |             |
|----------|-------------|
| MISURA   | imp. 74 mm  |
| FINITURA | PCH C/FIORE |
| IMBALLO  | 25          |



**art. 3.2603**

maniglia Extra anticata

|          |            |
|----------|------------|
| MISURA   | imp. 74 mm |
| FINITURA | PBN F. BLU |
| IMBALLO  | 25         |



**art. 3.2606**

maniglia Extra anticata

|          |                |
|----------|----------------|
| MISURA   | imp. 74 mm     |
| FINITURA | PBN F. MARRONE |
| IMBALLO  | 25             |



**art. 3.2607**

maniglia Extra anticata

|          |                 |
|----------|-----------------|
| MISURA   | imp. 74 mm      |
| FINITURA | PBN F. MIOSOTIS |
| IMBALLO  | 25              |



**art. 3.2608**

maniglia Extra anticata

|          |            |
|----------|------------|
| MISURA   | imp. 74 mm |
| FINITURA | PCH/ANT    |
| IMBALLO  | 25         |



**art. 3.3000**  
maniglia Stile

|          |            |
|----------|------------|
| MISURA   | imp. 96 mm |
| FINITURA | PBN/Z. ANT |
| IMBALLO  | 25         |



**art. 3.3001**  
maniglia Stile z. anticata

|          |                |
|----------|----------------|
| MISURA   | imp. 96 mm     |
| FINITURA | PBN MELA VERDE |
| IMBALLO  | 25             |



**art. 3.3002**  
maniglia Stile z. anticata

|          |             |
|----------|-------------|
| MISURA   | imp. 96 mm  |
| FINITURA | PCH C/FIORE |
| IMBALLO  | 25          |



**art. 3.3003**  
maniglia Stile z. anticata

|          |            |
|----------|------------|
| MISURA   | imp. 96 mm |
| FINITURA | PBN F. BLU |
| IMBALLO  | 25         |



**art. 3.3006**  
maniglia Stile z. anticata

|          |                |
|----------|----------------|
| MISURA   | imp. 96 mm     |
| FINITURA | PBN F. MARRONE |
| IMBALLO  | 25             |



**art. 3.3007**  
maniglia Stile z. anticata

|          |                 |
|----------|-----------------|
| MISURA   | imp. 96 mm      |
| FINITURA | PCH F. MIOSOTIS |
| IMBALLO  | 25              |



**art. 3.3008**  
maniglia Stile

|          |            |
|----------|------------|
| MISURA   | imp. 96 mm |
| FINITURA | PCH/Z. ANT |
| IMBALLO  | 25         |



3.25 Serie

# MANIGLIETTE



### art. 3.2510

maniglia per mobili

|          | 3.2510.08 | 3.2510.10 | 3.2510.12 | 3.2510.14 |
|----------|-----------|-----------|-----------|-----------|
| MISURA   | 80 mm     | 100 mm    | 120 mm    | 140 mm    |
| FINITURA | OLV       | OLV       | OLV       | OLV       |
| IMBALLO  | 50        | 50        | 50        | 50        |
| FINITURA | CR        | CR        | CR        | CR        |



### art. 3.2520

maniglia Flora

|          |        |
|----------|--------|
| MISURA   | 160 mm |
| FINITURA | FUMÈ   |
| IMBALLO  | 12     |



### art. 3.2535

maniglia scanalata

|          |        |        |
|----------|--------|--------|
| MISURA   | 140 mm | 140 mm |
| FINITURA | OLV    | BR     |
| IMBALLO  | 30     | 30     |



### art. 3.2536

maniglia rigata

|          |        |        |
|----------|--------|--------|
| MISURA   | 140 mm | 140 mm |
| FINITURA | OLV    | BR     |
| IMBALLO  | 30     | 30     |



### art. 3.2580

maniglia liscia

|          |        |
|----------|--------|
| MISURA   | 150 mm |
| FINITURA | OLV    |
| IMBALLO  | 12     |



### art. 3.2585

maniglia decorata

|          |        |
|----------|--------|
| MISURA   | 125 mm |
| FINITURA | OLV    |
| IMBALLO  | 12     |



**art. 3.2590**

maniglia Conchiglia rigata

|          |          |          |
|----------|----------|----------|
| MISURA   | 74X36 mm | 74X36 mm |
| FINITURA | OLV      | ANT      |
| IMBALLO  | 25       | 25       |



**art. 3.2595**

maniglia Conchiglia liscia

|          |          |          |
|----------|----------|----------|
| MISURA   | 84X36 mm | 84X36 mm |
| FINITURA | OLV      | CRS      |
| IMBALLO  | 25       | 25       |



**art. 3.2610**

maniglia Rialto

|          | 3.2610.06 | 3.2610.09 |
|----------|-----------|-----------|
| MISURA   | 64 mm     | 96 mm     |
| FINITURA | OLV       | OLV       |
| IMBALLO  | 25        | 25        |
| FINITURA | OGR       | OGR       |
| FINITURA | CR        | CR        |
| FINITURA | CRS       | CRS       |

**art. 3.2615**

maniglia Bastoncino

|          | 3.2615.06 | 3.2615.09 | 3.2615.12 |
|----------|-----------|-----------|-----------|
| MISURA   | 64 mm     | 96 mm     | 128 mm    |
| FINITURA | OLV       | OLV       | OLV       |
| IMBALLO  | 25        | 25        | 25        |
| FINITURA | OGR       | OGR       | OGR       |
| FINITURA | CR        | CR        | CR        |
| FINITURA | CRS       | CRS       | CRS       |



**art. 3.2620**

maniglia Firenze

|             |          |          |          |
|-------------|----------|----------|----------|
| MISURA      | 115 mm   | 145 mm   | 220 mm   |
| FINITURA    | FERRO NR | FERRO NR | FERRO NR |
| IMBALLO     | 12       | 12       | 12       |
| <b>EURO</b> |          |          |          |

**art. 3.2630**

maniglia Rustica

|          |          |
|----------|----------|
| MISURA   | 150 mm   |
| FINITURA | FERRO NR |
| IMBALLO  | 24       |



**art. 3.2633**

maniglia Twist

|          | 3.2633.30 | 3.2633.40 |
|----------|-----------|-----------|
| MISURA   | ø 30 mm   | ø 40 mm   |
| FINITURA | FERRO NR  | FERRO NR  |
| IMBALLO  | 25        | 25        |



**art. 3.2635**

maniglia Basket

|          |          |
|----------|----------|
| MISURA   | 125 mm   |
| FINITURA | FERRO NR |
| IMBALLO  | 12       |



**art. 3.2640**

maniglia Ponte

|          | 3.2640.I0 | 3.2640.I2 | 3.2640.I5 |
|----------|-----------|-----------|-----------|
| MISURA   | 100 mm    | 125 mm    | 150 mm    |
| FINITURA | OLV       | OLV       | OLV       |
| IMBALLO  | 25        | 25        | 25        |
| FINITURA | BR        | BR        | BR        |
| FINITURA | CR        | CR        | CR        |
| FINITURA | CRS       | CRS       | CRS       |



**art. 3.2645**

maniglia Biemme

|          | 3.2645.I0 | 3.2645.I5 |
|----------|-----------|-----------|
| MISURA   | 100 mm    | 150 mm    |
| FINITURA | OLV       | OLV       |
| IMBALLO  | 25        | 25        |
| FINITURA | CR        | CR        |



**art. 3.2660**

maniglia Bridge - int. 32 mm

|          |          |          |          |          |
|----------|----------|----------|----------|----------|
| MISURA   | 50x20 mm | 50x20 mm | 50x20 mm | 50x20 mm |
| FINITURA | OLV      | BR       | CR       | CRS      |
| IMBALLO  | 30       | 30       | 30       | 30       |



**art. 3.2695**

maniglia Geco con viti in vista

|          |        |        |        |
|----------|--------|--------|--------|
| MISURA   | 125 mm | 125 mm | 125 mm |
| FINITURA | OLV    | CR     | CRS    |
| IMBALLO  | 25     | 25     | 25     |



**art. 3.3010**

maniglia Linea ø 12 mm

|          | 3.3010.12 | 3.3010.16 | 3.3010.22 | 3.3010.28 |
|----------|-----------|-----------|-----------|-----------|
| MISURA   | 128 mm    | 160 mm    | 224 mm    | 288 mm    |
| FINITURA | INOX      | INOX      | INOX      | INOX      |
| IMBALLO  | 12        | 12        | 12        | 12        |



**art. 3.3020**

maniglia Poros

|          | 3.3020.09  | 3.3020.12  |
|----------|------------|------------|
| MISURA   | 96 mm      | 128 mm     |
| FINITURA | Z. NIK SAT | Z. NIK SAT |
| IMBALLO  | 12         | 12         |



**art. 3.3030**

maniglia Punto

|          | 3.3030.09  | 3.3030.12  |
|----------|------------|------------|
| MISURA   | 96 mm      | 128 mm     |
| FINITURA | Z. NIK SAT | Z. NIK SAT |
| IMBALLO  | 12         | 12         |



**art. 3.3040**

maniglia Fox

|          | 3.3040.09  | 3.3040.12  |
|----------|------------|------------|
| MISURA   | 96 mm      | 128 mm     |
| FINITURA | Z. NIK SAT | Z. NIK SAT |
| IMBALLO  | 12         | 12         |



**art. 3.3050**

maniglia Antigone

|          | 3.3050.09  | 3.3050.12  |
|----------|------------|------------|
| MISURA   | 96 mm      | 128 mm     |
| FINITURA | Z. NIK SAT | Z. NIK SAT |
| IMBALLO  | 12         | 12         |



3103 Serie

# MANIGLIONI

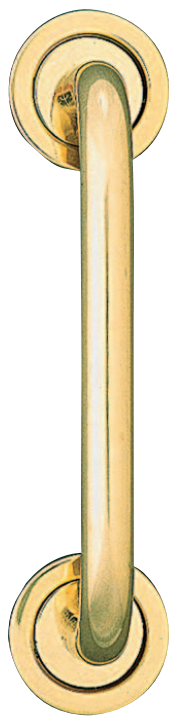

**art. 3.5000**  
maniglione Capri diritto  
rosetta ø 50 mm - interasse 170 mm

|          |     |     |
|----------|-----|-----|
| FINITURA | OLV | OGR |
| IMBALLO  | 2   | 2   |

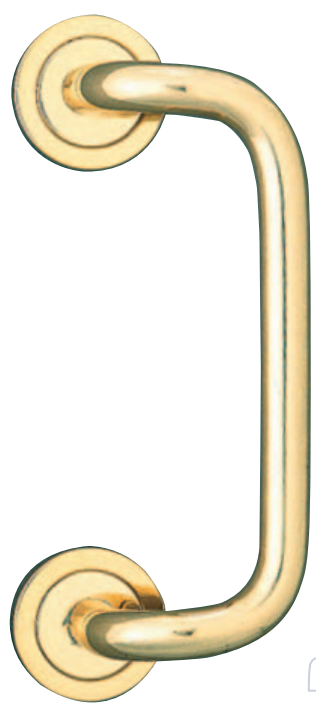

**art. 3.5010**  
maniglione Capri zancato  
rosetta ø 50 mm - interasse 170 mm

|          |     |
|----------|-----|
| FINITURA | OLV |
| IMBALLO  | 2   |

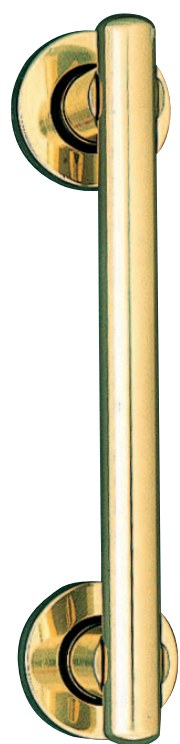

**art. 3.5020**  
maniglione Ibiza diritto  
rosetta ø 45 mm - interasse 150 mm

|          |     |     |
|----------|-----|-----|
| FINITURA | OLV | CRS |
| IMBALLO  | 2   | 2   |

**art. 3.5020**  
maniglione Ibiza diritto  
rosetta ø 45 mm - interasse 200 mm

|          |     |     |
|----------|-----|-----|
| FINITURA | OLV | CRS |
| IMBALLO  | 2   | 2   |



**art. 3.5030**  
maniglione Star diritto  
rosetta ø 45 mm - interasse 200 mm

|          |         |
|----------|---------|
| FINITURA | OLV/SAT |
| IMBALLO  | 2       |

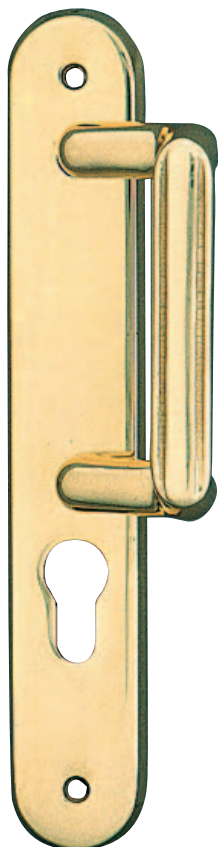

**art. 3.5040**

maniglione Brugi decentrato  
placca foro yale dx e sx

|          |     |
|----------|-----|
| FINITURA | OLV |
| IMBALLO  | 2   |



**art. 3.5050**

maniglione Impero  
interasse 200 mm

|          |     |     |
|----------|-----|-----|
| FINITURA | OLV | OGR |
| IMBALLO  | 2   | 2   |

**art. 3.5050**

maniglione Impero  
interasse 300 mm

|          |     |     |
|----------|-----|-----|
| FINITURA | OLV | OGR |
| IMBALLO  | 2   | 2   |

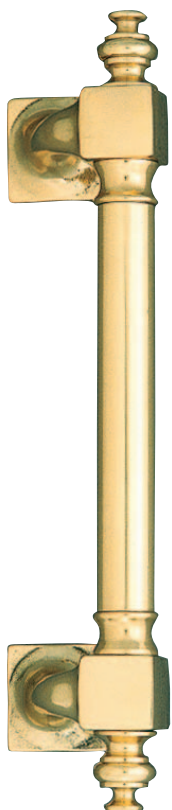

**art. 3.5060**

maniglione Urano  
interasse 200 mm

|          |     |     |
|----------|-----|-----|
| FINITURA | OLV | OGR |
| IMBALLO  | 2   | 2   |

**art. 3.5060**

maniglione Urano  
interasse 300 mm

|          |     |     |
|----------|-----|-----|
| FINITURA | OLV | OGR |
| IMBALLO  | 2   | 2   |



**art. 3.5070**

maniglione Rodi  
interasse 150 mm

|          |     |     |
|----------|-----|-----|
| FINITURA | OLV | OGR |
| IMBALLO  | 2   | 2   |

**art. 3.5070**

maniglione Rodi  
interasse 200 mm

|          |     |     |
|----------|-----|-----|
| FINITURA | OLV | OGR |
| IMBALLO  | 2   | 2   |

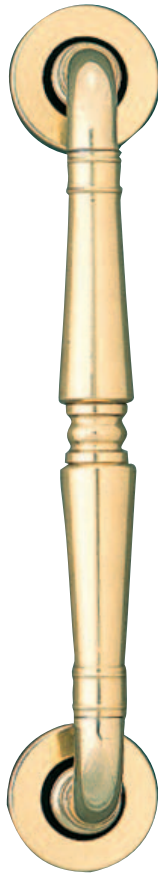

**art. 3.5080**

maniglione Venezia diritto  
rosetta ø 45 mm - interasse 220 mm

|          |     |     |         |
|----------|-----|-----|---------|
| FINITURA | OLV | OGR | ARG ANT |
| IMBALLO  | 2   | 2   | 2       |



**art. 3.5090**

maniglione Georgian  
rosetta ø 45 mm - viti in vista  
interasse 150 mm

|          |     |
|----------|-----|
| FINITURA | OLV |
| IMBALLO  | 2   |



**art. 3.5100**

maniglione Imperial  
placca - interasse 235 mm

|          |     |        |
|----------|-----|--------|
| FINITURA | OLS | CR/CRS |
| IMBALLO  | 2   | 2      |



**art. 3.5140**

maniglione Pireo **bicolore**  
 interasse 180 mm  
 rosetta ø 40 mm - perno filettato  
 oppure rosetta ø 45 mm - sottoplastica

| FINITURA | OLV/SAT | CR/CRS |
|----------|---------|--------|
| IMBALLO  | 2       | 2      |

**art. 3.5140**

maniglione Pireo **monocolore**  
 interasse 180 mm  
 rosetta ø 40 mm - perno filettato  
 oppure rosetta ø 45 mm - sottoplastica

| FINITURA | OLV | OGR | SAT | CRS |
|----------|-----|-----|-----|-----|
| IMBALLO  | 2   | 2   | 2   | 2   |



**art. 3.5470**

maniglione Pireo zancato **bicolore**  
 rosetta ø 40 mm - interasse 180 mm

| FINITURA | OLV/SAT | CR/CRS |
|----------|---------|--------|
| IMBALLO  | 2       | 2      |

**art. 3.5470**

maniglione Pireo zancato **monocolore**  
 rosetta ø 40 mm - interasse 180 mm

| FINITURA | OLV | OGR | SAT | CR | CRS |
|----------|-----|-----|-----|----|-----|
| IMBALLO  | 2   | 2   | 2   | 2  | 2   |



**art. 3.5230**

maniglione Desy  
rosetta ø 50 mm  
interasse 185 mm

|          |     |     |
|----------|-----|-----|
| FINITURA | OLV | OGR |
| IMBALLO  | 2   | 2   |

|          |    |     |
|----------|----|-----|
| FINITURA | CR | CRS |
|----------|----|-----|



**art. 3.5240**

maniglione Colonia  
rosetta ø 50 mm - interasse 185 mm

|          |     |
|----------|-----|
| FINITURA | OLV |
| IMBALLO  | 2   |



**art. 3.5250**

maniglione Olaria  
rosetta ø 50 mm - interasse 200 mm

|          |     |
|----------|-----|
| FINITURA | OLV |
| IMBALLO  | 2   |



**art. 3.5260**

maniglione Garda con rosetta ø 45 mm  
interasse variabile da 170 a 205 mm

|          |     |     |
|----------|-----|-----|
| FINITURA | OLV | OGR |
| IMBALLO  | 2   | 2   |



**art. 3.5270**

maniglione Flower  
interasse 225 mm

|          |     |
|----------|-----|
| FINITURA | OLV |
| IMBALLO  | 4   |

**art. 3.5280**

maniglione Omega  
placca Hotel 278x57 mm

|          |     |     |
|----------|-----|-----|
| FINITURA | OLV | CRS |
| IMBALLO  | 2   | 2   |



**art. 3.5290**

maniglione Desy rigato  
rosetta ø 50 mm  
interasse 185 mm

|          |     |     |
|----------|-----|-----|
| FINITURA | OLV | OGR |
| IMBALLO  | 2   | 2   |

|          |    |     |
|----------|----|-----|
| FINITURA | CR | CRS |
|----------|----|-----|

**art. 3.5340**

maniglione Porto diritto  
rosetta ø 50 mm - interasse 200 mm

| FINITURA | OLV | OGR | ARG ANT | PVD |
|----------|-----|-----|---------|-----|
| IMBALLO  | 2   | 2   | 2       | 2   |



**art. 3.5350**

maniglione Porto zancato  
rosetta ø 50 mm - interasse 200 mm

| FINITURA | OLV | OGR | ARG ANT | PVD |
|----------|-----|-----|---------|-----|
| IMBALLO  | 2   | 2   | 2       | 2   |



**art. 3.5330**

maniglione Cometa  
rosetta ø 50 mm  
interasse 210 mm

|          |     |     |
|----------|-----|-----|
| FINITURA | OLV | OGR |
| IMBALLO  | 2   | 2   |

|          |    |     |
|----------|----|-----|
| FINITURA | CR | CRS |
|----------|----|-----|



**art. 3.5360**

maniglione Clara dritto  
rosetta ø 50 mm  
interasse 180 mm

|          |     |     |
|----------|-----|-----|
| FINITURA | OLV | OGR |
| IMBALLO  | 2   | 2   |

|          |    |     |
|----------|----|-----|
| FINITURA | CR | CRS |
|----------|----|-----|



**art. 3.5370**

maniglione Silvia dritto rigato  
rosetta ø 50 mm  
interasse 180 mm

|          |     |     |
|----------|-----|-----|
| FINITURA | OLV | OGR |
| IMBALLO  | 2   | 2   |

|          |    |     |
|----------|----|-----|
| FINITURA | CR | CRS |
|----------|----|-----|



**art. 3.5380**

maniglione Thay  
interasse 185 mm

|          |     |
|----------|-----|
| FINITURA | OLV |
| IMBALLO  | 2   |

**art. 3.5400**

maniglione Pegaso  
rosetta ø 50 mm - interasse 250 mm

|          |     |     |     |    |     |     |
|----------|-----|-----|-----|----|-----|-----|
| FINITURA | OLV | SAT | OGR | CR | CRS | PVD |
| IMBALLO  | 2   | 2   | 2   | 2  | 2   | 2   |



**art. 3.5450**

maniglione Luxor  
rosetta ø 50 mm - interasse 195 mm

|          |         |        |
|----------|---------|--------|
| FINITURA | OLV/SAT | CR/CRS |
| IMBALLO  | 2       | 2      |



**art. 3.5412**

maniglione Corinne  
 rosetta ø 45 mm - viti in vista  
 interasse 225 mm

|          |     |     |     |
|----------|-----|-----|-----|
| FINITURA | OLV | ANT | CRS |
| IMBALLO  | 2   | 2   | 2   |

|          |     |         |         |
|----------|-----|---------|---------|
| FINITURA | CRS | ORO ANT | ARG ANT |
|----------|-----|---------|---------|



**art. 3.5512**

maniglione Liberty  
 rosetta ø 45 mm - viti in vista  
 interasse 225 mm

|          |     |     |     |
|----------|-----|-----|-----|
| FINITURA | OLV | ANT | CRS |
| IMBALLO  | 2   | 2   | 2   |

|          |         |         |
|----------|---------|---------|
| FINITURA | ORO ANT | ARG ANT |
|----------|---------|---------|



**art. 3.5612**

maniglione Lyon  
 rosetta ø 45 - viti in vista  
 interasse 225 mm

|          |     |     |     |
|----------|-----|-----|-----|
| FINITURA | OLV | ANT | CRS |
| IMBALLO  | 2   | 2   | 2   |

|          |         |         |
|----------|---------|---------|
| FINITURA | ORO ANT | ARG ANT |
|----------|---------|---------|



**art. 3.5480**

maniglione Elly Bic  
interasse 220 mm

|          |         |        |
|----------|---------|--------|
| FINITURA | OLV/SAT | CR/CRS |
| IMBALLO  | 2       | 2      |



**art. 3.5490**

maniglione Esse  
interasse 240 mm

|             |              |              |              |
|-------------|--------------|--------------|--------------|
| FINITURA    | OLV          | SAT          | OGR          |
| IMBALLO     | 2            | 2            | 2            |
| <b>EURO</b> | <b>47,90</b> | <b>49,90</b> | <b>49,90</b> |

|          |    |     |     |
|----------|----|-----|-----|
| FINITURA | CR | CRS | PVD |
|----------|----|-----|-----|



**art. 3.5530**

maniglione Laura  
rosetta quadra 50X50 mm  
interasse 200 mm

|          |         |        |
|----------|---------|--------|
| FINITURA | OLV/SAT | CR/CRS |
| IMBALLO  | 2       | 2      |



**art. 3.5540**

maniglione Cris inox  
rosetta ø 50 mm  
interasse 200 mm

|          |        |     |
|----------|--------|-----|
| FINITURA | NIK/CR | PVD |
| IMBALLO  | 2      | 2   |



**art. 3.5624.24**

maniglione Eos  
 placca 240x42 mm  
 interasse 220 mm

|          |     |         |
|----------|-----|---------|
| FINITURA | OLV | ORO ANT |
| IMBALLO  | 2   | 2       |



**art. 3.5659**

maniglione Eos  
 rosetta ø 50 mm con bordo  
 interasse 170 mm

|          |     |         |
|----------|-----|---------|
| FINITURA | OLV | ORO ANT |
| IMBALLO  | 2   | 2       |



**art. 3.5590**

maniglione Sandy  
 rosetta quadra 50x50 mm  
 interasse 160 mm

|          |           |
|----------|-----------|
| FINITURA | Z. CR/NIK |
| IMBALLO  | 2         |



**art. 3.5660**

maniglione Samba  
 rosetta ø 50 mm  
 interasse 200 mm

|          |     |     |     |
|----------|-----|-----|-----|
| FINITURA | OLV | SAT | CRS |
| IMBALLO  | 2   | 2   | 2   |

**art. 3.5220**

maniglione Vienna  
interasse 205 mm

|          |     |    |
|----------|-----|----|
| FINITURA | OLS | BR |
| IMBALLO  | 2   | 2  |

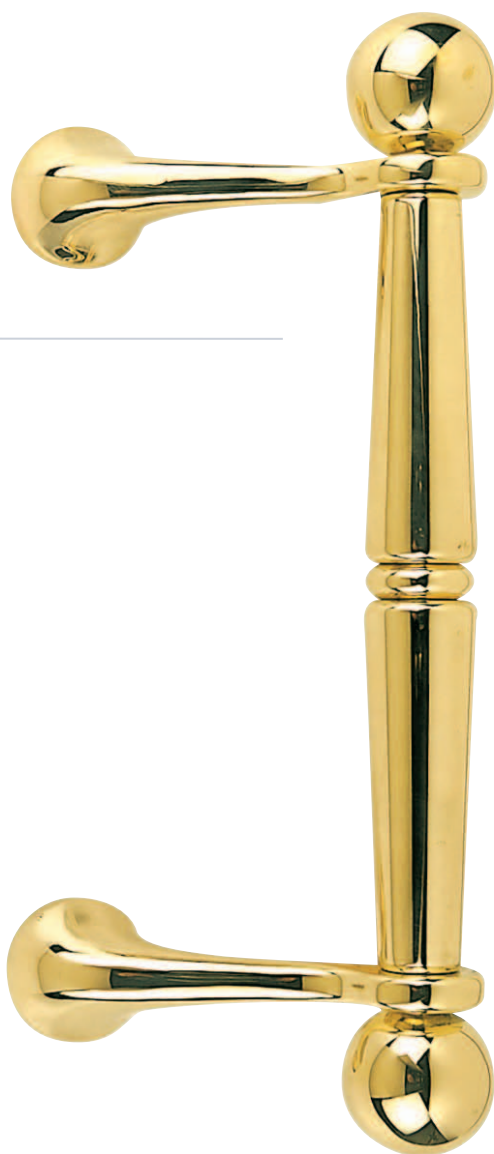

**art. 3.5640**

maniglione Riccio  
rosetta ø 50 mm - interasse 245 mm

|          |     |     |     |     |
|----------|-----|-----|-----|-----|
| FINITURA | OLV | OGR | CRS | PVD |
| IMBALLO  | 2   | 2   | 2   | 2   |



**art. 3.5670**

maniglione Arco  
interasse 240 mm

|          |     |     |
|----------|-----|-----|
| FINITURA | OLV | OGR |
| IMBALLO  | 2   | 2   |

|          |     |     |
|----------|-----|-----|
| FINITURA | CRS | PVD |
|----------|-----|-----|



**art. 3.5680**

maniglione Pilar  
rosetta ø 50 mm  
interasse 200 mm

|          |     |        |        |
|----------|-----|--------|--------|
| FINITURA | OLV | OGR OP | CR/CRS |
| IMBALLO  | 2   | 2      | 2      |



**art. 3.5690**

maniglione Pilar  
rosetta quadra 50X50 mm  
interasse 200 mm

|          |     |        |        |
|----------|-----|--------|--------|
| FINITURA | OLV | OGR OP | CR/CRS |
| IMBALLO  | 2   | 2      | 2      |

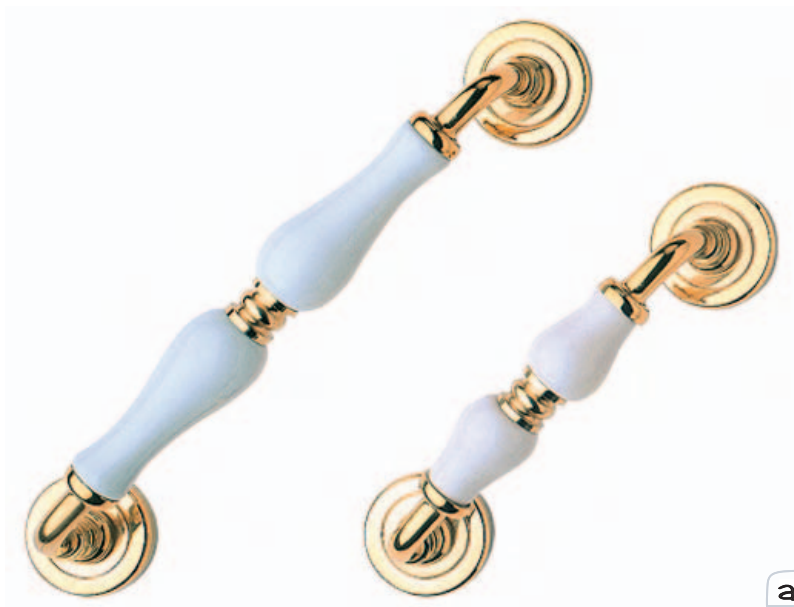

**art. 3.5165.16**

maniglione Sonia in porcellana bianca  
rosetta Lux ø 45 mm - interasse 140 mm

**art. 3.5165.26**

maniglione Sonia in porcellana bianca  
rosetta Lux ø 45 mm - interasse 215 mm

|          |     |     |
|----------|-----|-----|
| FINITURA | OLV | ANT |
| IMBALLO  | 2   | 2   |



**art. 3.5175.16**

maniglione Gemma in porcellana champagne decorata  
rosetta Lux ø 45 mm - interasse 140 mm

**art. 3.5175.26**

maniglione Gemma in porcellana champagne decorata  
rosetta Lux ø 45 mm - interasse 215 mm

|          |     |     |
|----------|-----|-----|
| FINITURA | OLV | ANT |
| IMBALLO  | 2   | 2   |



**art. 3.5185.16**

maniglione Lara in porcellana champagne  
con rosetta Lux ø 45 mm - interasse 140 mm

**art. 3.5185.26**

maniglione Lara in porcellana champagne  
con rosetta Lux ø 45 mm - interasse 215 mm

|          |     |     |
|----------|-----|-----|
| FINITURA | OLV | ANT |
| IMBALLO  | 2   | 2   |



**art. 3.5195.16**

maniglione Anna in porcellana bianca decorata  
rosetta Lux ø 45 mm - interasse 140 mm

**art. 3.5195.26**

maniglione Anna in porcellana bianca decorata  
rosetta Lux ø 45 mm - interasse 215 mm

|          |     |     |
|----------|-----|-----|
| FINITURA | OLV | ANT |
| IMBALLO  | 2   | 2   |



**art. 3.5325.16**

maniglione Sonia Blu in porcellana bianca  
decorata c/fiore blu rosetta Lux ø 45 mm - interasse 140 mm

**art. 3.5325.26**

maniglione Sonia Blu in porcellana bianca  
decorata c/fiore blu rosetta Lux ø 45 mm - interasse 215 mm

|          |     |     |
|----------|-----|-----|
| FINITURA | OLV | ANT |
| IMBALLO  | 2   | 2   |

3130 Serie

# MANIGLIONI INOX



**art. 3.5710**

coppia maniglioni  
 ø 32x350x1,5 mm

|          |          |
|----------|----------|
| FINITURA | INOX SAT |
| IMBALLO  | 1        |

**art. 3.5710.OIS**

maniglione singolo  
 ø 32x350x1,5 mm

|          |          |
|----------|----------|
| FINITURA | INOX SAT |
| IMBALLO  | 2        |

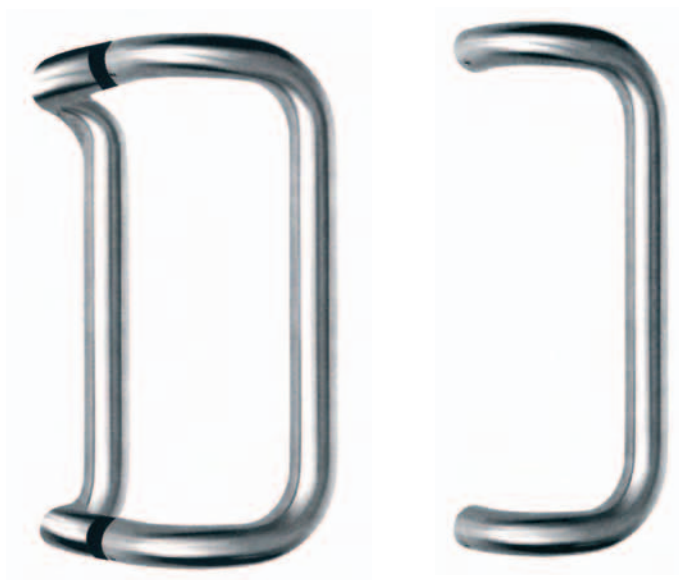

**art. 3.5720**

coppia maniglioni  
 ø 32x350x1,5 mm

|          |          |
|----------|----------|
| FINITURA | INOX SAT |
| IMBALLO  | 1        |

**art. 3.5720.OIS**

maniglione singolo  
 ø 32x350x1,5 mm

|          |          |
|----------|----------|
| FINITURA | INOX SAT |
| IMBALLO  | 2        |

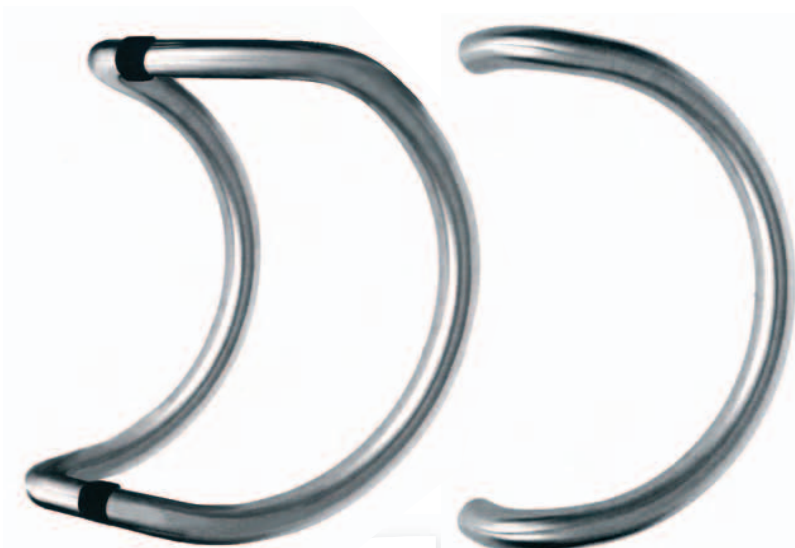

**art. 3.5730**

coppia maniglioni  
 ø 32x350x1,5 mm

|          |          |
|----------|----------|
| FINITURA | INOX SAT |
| IMBALLO  | 1        |

**art. 3.5730.OIS**

maniglione singolo  
 ø 32x350x1,5 mm

|          |          |
|----------|----------|
| FINITURA | INOX SAT |
| IMBALLO  | 2        |



**art. 3.5740**

coppia maniglioni  
 ø 32x350x1,5 mm

|          |          |
|----------|----------|
| FINITURA | INOX SAT |
| IMBALLO  | 1        |

**art. 3.5740.OIS**

maniglione singolo  
 ø 32x350x1,5 mm

|          |          |
|----------|----------|
| FINITURA | INOX SAT |
| IMBALLO  | 2        |

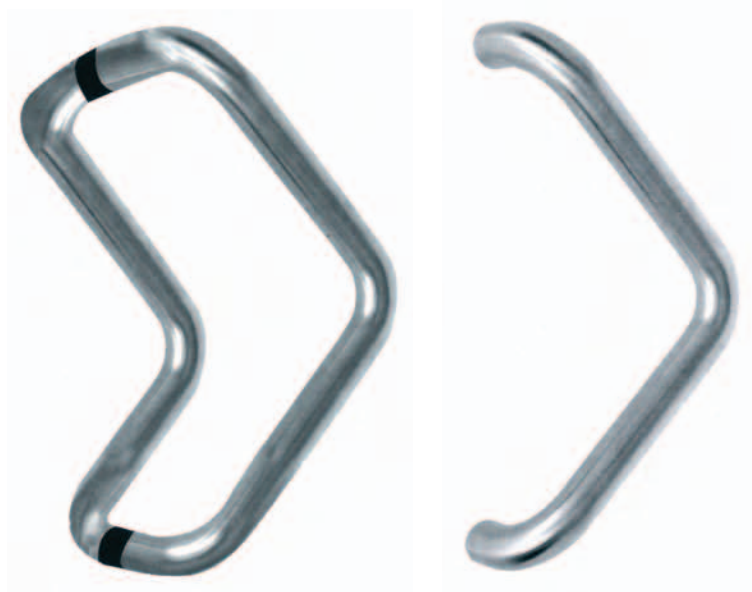

**art. 3.5750**

coppia maniglioni  
 ø 32x350x1,5 mm

|          |          |
|----------|----------|
| FINITURA | INOX SAT |
| IMBALLO  | 1        |

**art. 3.5750.OIS**

maniglione singolo  
 ø 32x350x1,5 mm

|          |          |
|----------|----------|
| FINITURA | INOX SAT |
| IMBALLO  | 2        |



**art. 3.5760**

coppia maniglioni  
 ø 32x350x1,5 mm

|          |          |
|----------|----------|
| FINITURA | INOX SAT |
| IMBALLO  | 1        |

**art. 3.5760.OIS**

maniglione singolo  
 ø 32x350x1,5 mm

|          |          |
|----------|----------|
| FINITURA | INOX SAT |
| IMBALLO  | 2        |

### art. 3.5770

maniglione linea **dritto**  
con possibilità di lunghezze speciali su richiesta

|               |          |          |          |
|---------------|----------|----------|----------|
| MISURA INT.   | 210 mm   | 300 mm   | 300 mm   |
| MISURA LUNGH. | 300 mm   | 400 mm   | 500 mm   |
| FINITURA      | INOX SAT | INOX SAT | INOX SAT |
| IMBALLO       | 2        | 2        | 2        |

|               |        |        |         |
|---------------|--------|--------|---------|
| MISURA INT.   | 400 mm | 600 mm | 900 mm  |
| MISURA LUNGH. | 600 mm | 800 mm | 1200 mm |

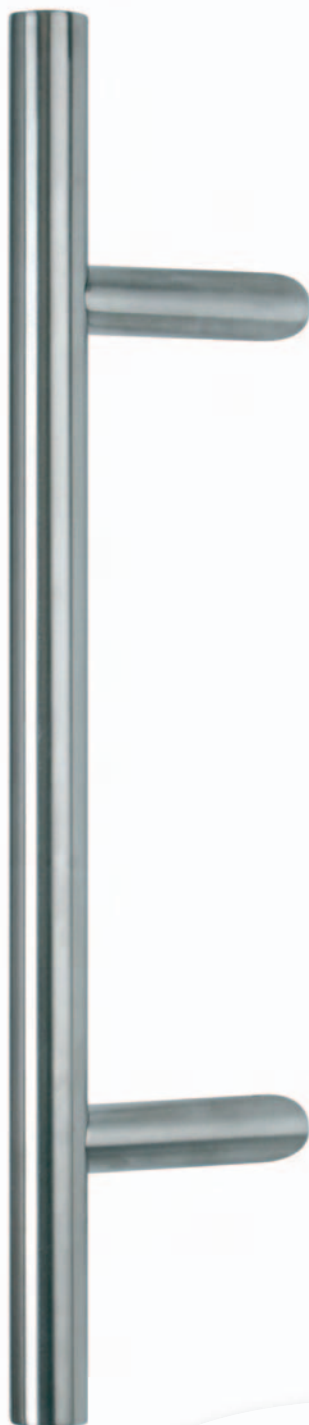
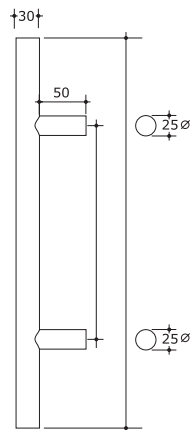

### art. 9.0300

kit di montaggio  
per maniglioni singolo



### art. 9.0310

kit di montaggio per maniglioni  
accoppiati per porte a vetro - art. 3.5770



### art. 9.0320

kit di montaggio per maniglioni  
accoppiati per porte a vetro - art. 3.5780

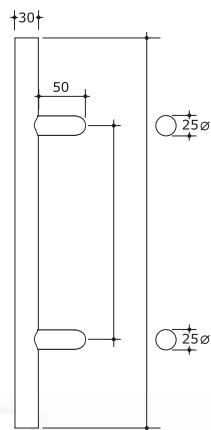

### art. 3.5780

maniglione linea **decentrato**  
con possibilità di lunghezze speciali su richiesta

|               |          |          |          |
|---------------|----------|----------|----------|
| MISURA INT.   | 210 mm   | 300 mm   | 300 mm   |
| MISURA LUNGH. | 300 mm   | 400 mm   | 500 mm   |
| FINITURA      | INOX SAT | INOX SAT | INOX SAT |
| IMBALLO       | 2        | 2        | 2        |

|               |        |        |         |
|---------------|--------|--------|---------|
| MISURA INT.   | 400 mm | 600 mm | 900 mm  |
| MISURA LUNGH. | 600 mm | 800 mm | 1200 mm |



## art. 3.5800

coppia maniglione a scatto  
per alzanti scorrevoli  $\varnothing$  20x250 mm

|             |               |               |               |
|-------------|---------------|---------------|---------------|
| FINITURA    | OLV           | ANT           | CRS           |
| IMBALLO     | 1             | 1             | 1             |
| <b>EURO</b> | <b>166,00</b> | <b>171,00</b> | <b>185,00</b> |



## art. 3.5900

coppia maniglione a scatto  
per alzanti scorrevoli singoli  $\varnothing$  20x250 mm

|          |     |     |    |     |
|----------|-----|-----|----|-----|
| FINITURA | OLV | OGR | CR | CRS |
| IMBALLO  | 2   | 2   | 2  | 2   |



### art. 3.2550

manettoncino Gaudel  
rosetta ø 40 mm - interasse 150 mm

| FINITURA | OLV | OGR | SAT | CR | CRS | ORO ANT |
|----------|-----|-----|-----|----|-----|---------|
| IMBALLO  | 6   | 6   | 6   | 6  | 6   | 6       |



### art. 3.2670

manettoncino Nike  
placca sagomata 102x48 mm

| FINITURA | OLV | ANT |
|----------|-----|-----|
| IMBALLO  | 2   | 2   |



#### SISTEMA DI MONTAGGIO



### art. 3.2680

manettoncino Duna  
interasse 160 mm

| FINITURA | OLV | OGR | CRS |
|----------|-----|-----|-----|
| IMBALLO  | 6   | 6   | 6   |



**SISTEMA DI MONTAGGIO**



**art. 3.2690.16**

manettoncino Slik  
interasse 160 mm

| FINITURA | OLV | OGR | CRS |
|----------|-----|-----|-----|
| IMBALLO  | 6   | 6   | 6   |

**art. 3.2690.20**

manettoncino Slik  
interasse 200 mm

| FINITURA | OLV | OGR | CRS |
|----------|-----|-----|-----|
| IMBALLO  | 6   | 6   | 6   |



**SISTEMA DI MONTAGGIO**



**art. 3.5430**

manettoncino Iber  
interasse 200 mm

| FINITURA | OLV | SAT | CRS |
|----------|-----|-----|-----|
| IMBALLO  | 6   | 6   | 6   |



**SISTEMA DI MONTAGGIO**



**art. 3.5620 BIC**

manettoncino Flexa **bicolore**  
interasse 200 mm

| FINITURA | OLV/SAT | CR/CRS |
|----------|---------|--------|
| IMBALLO  | 6       | 6      |

**art. 3.5620**

manettoncino Flexa **monocolore**  
interasse 200 mm

| FINITURA | OLV | OGR |
|----------|-----|-----|
| IMBALLO  | 6   | 6   |



**SISTEMA DI MONTAGGIO**



**art. 3.5630 BIC**

manettoncino Clara **bicolore**  
interasse 200 mm

| FINITURA | OLV/SAT | CR/CRS |
|----------|---------|--------|
| IMBALLO  | 6       | 6      |

**art. 3.5630**

manettoncino Clara **monocolore**  
interasse 200 mm

| FINITURA | OLV   | OGR   |
|----------|-------|-------|
| IMBALLO  | 6     | 6     |
| EURO     | 37,20 | 38,50 |

# BATTENTI PORTA



**art. 7.4210**

battente Maxi Leone  
ø 200 mm

|          |     |         |
|----------|-----|---------|
| FINITURA | OLV | ORO ANT |
| IMBALLO  | 1   | 1       |



**art. 7.4280**

battente Mare  
125x110 mm

|          |     |     |
|----------|-----|-----|
| FINITURA | OLV | OGR |
| IMBALLO  | 2   | 2   |



**art. 7.4010**

battente Barocco

|          | 7.4010.12 | 7.4010.15 |
|----------|-----------|-----------|
| MISURA   | 120 mm    | 150 mm    |
| FINITURA | OLV       | OLV       |
| IMBALLO  | 2         | 2         |

|          |     |     |
|----------|-----|-----|
| FINITURA | ANT | ANT |
|----------|-----|-----|



**art. 7.4013**

battente Leoncino  
160x90 mm

|          |     |     |              |
|----------|-----|-----|--------------|
| FINITURA | OLV | ANT | VERDE VENEZ. |
| IMBALLO  | 2   | 2   | 2            |



**art. 7.4015**

battente Leone  
200x100 mm

|          |     |     |
|----------|-----|-----|
| FINITURA | OLV | ANT |
| IMBALLO  | 2   | 2   |

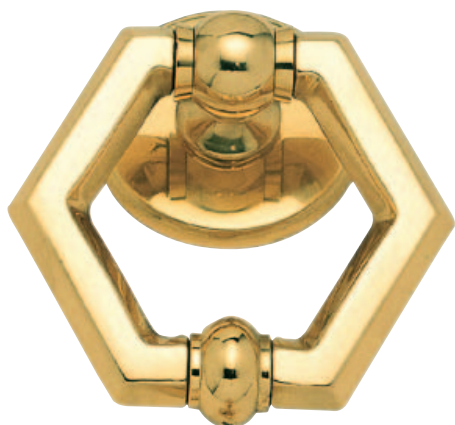

**art. 7.4020**

battente Esagonale

|          | 7.4020.10 | 7.4020.12 |
|----------|-----------|-----------|
| MISURA   | 100 mm    | 120 mm    |
| FINITURA | OLV       | OLV       |
| IMBALLO  | 2         | 2         |
| EURO     | 71,40     | 79,70     |



**art. 7.4024.09**

battente Lira  
100x190 mm

|          |     |     |
|----------|-----|-----|
| FINITURA | OLV | ANT |
| IMBALLO  | 2   | 2   |



**art. 7.4027**

battente America  
135 mm

|          |     |
|----------|-----|
| FINITURA | OLV |
| IMBALLO  | 2   |



**art. 7.4030**

battente Roma  
180 mm

|          |     |
|----------|-----|
| FINITURA | OLV |
| IMBALLO  | 2   |



**art. 7.4110**

battente Anello

|          | 7.4110.09 | 7.4110.11 | 7.4110.13 |
|----------|-----------|-----------|-----------|
| MISURA   | 90 mm     | 110 mm    | 130 mm    |
| FINITURA | OLV       | OLV       | OLV       |
| IMBALLO  | 2         | 2         | 2         |

|          |     |     |     |
|----------|-----|-----|-----|
| FINITURA | OGR | OGR | OGR |
|----------|-----|-----|-----|

|          |     |     |     |
|----------|-----|-----|-----|
| FINITURA | CRS | CRS | CRS |
|----------|-----|-----|-----|



**art. 7.4050**

battente Georgian

|          | 7.4050.15 | 7.4050.20 |
|----------|-----------|-----------|
| MISURA   | 150 mm    | 200 mm    |
| FINITURA | OLV       | OLV       |
| IMBALLO  | 2         | 2         |

|          |     |     |
|----------|-----|-----|
| FINITURA | OGR | OGR |
|----------|-----|-----|



**art. 7.4060**

battente Victorian

|          | 7.4060.15 | 7.4060.20 |
|----------|-----------|-----------|
| MISURA   | 150 mm    | 200 mm    |
| FINITURA | OLV       | OLV       |
| IMBALLO  | 2         | 2         |

|          |     |     |
|----------|-----|-----|
| FINITURA | OGR | OGR |
|----------|-----|-----|



**art. 7.4040**

battente Regal  
140 mm

|          |     |
|----------|-----|
| FINITURA | OLV |
| IMBALLO  | 2   |



**art. 7.4075**

battente Manina media  
110x60 mm

|          |    |     |
|----------|----|-----|
| FINITURA | OL | ANT |
| IMBALLO  | 2  | 2   |



**art. 7.4130**

battente Cavallo  
140x120 mm

|          |     |
|----------|-----|
| FINITURA | ANT |
| IMBALLO  | 2   |



**art. 7.4140**

battente Maya  
160x95 mm

|          |     |
|----------|-----|
| FINITURA | ANT |
| IMBALLO  | 2   |



**art. 7.4150**

battente Medusa  
165x120 mm

|          |    |     |
|----------|----|-----|
| FINITURA | OL | ANT |
| IMBALLO  | 2  | 2   |



**art. 7.4160**

battente Impero  
125x100 mm

|             |              |              |
|-------------|--------------|--------------|
| FINITURA    | OL           | ANT          |
| IMBALLO     | 2            | 2            |
| <b>EURO</b> | <b>26,60</b> | <b>29,20</b> |



**art. 7.4170**

battente Leone big  
270x150 mm

|          |    |
|----------|----|
| FINITURA | OL |
| IMBALLO  | 1  |



**art. 7.4180**

battente York  
110 mm

|          |     |
|----------|-----|
| FINITURA | OLV |
| IMBALLO  | 2   |



**art. 7.4190**

battente Porto  
120 mm

|          |     |     |     |         |
|----------|-----|-----|-----|---------|
| FINITURA | OLV | CRS | OGR | ARG ANT |
| IMBALLO  | 2   | 2   | 2   | 2       |



**art. 7.4200**

battente Ring  
110 mm

|          |     |     |     |
|----------|-----|-----|-----|
| FINITURA | OLV | CRS | OGR |
| IMBALLO  | 2   | 2   | 2   |



**art. 7.4220**

battente Luxor  
115 mm

|          |     |
|----------|-----|
| FINITURA | OLV |
| IMBALLO  | 2   |



**art. 7.4230**

battente Denz  
ø 117 mm

|          |          |
|----------|----------|
| FINITURA | FERRO NR |
| IMBALLO  | 2        |



**art. 7.4240**

battente Basket  
117 mm

|          |          |
|----------|----------|
| FINITURA | FERRO NR |
| IMBALLO  | 2        |



**art. 7.4250**

battente Kora  
ø 113 mm

|          |          |
|----------|----------|
| FINITURA | FERRO NR |
| IMBALLO  | 2        |



**art. 7.4260**

battente Delfino  
140 mm

|          |     |    |
|----------|-----|----|
| FINITURA | OLV | CR |
| IMBALLO  | 2   | 2  |



**art. 7.4290**

battente Goccia  
140x65 mm

|          |     |         |
|----------|-----|---------|
| FINITURA | OLV | ORO ANT |
| IMBALLO  | 2   | 2       |

sist Serie

# CITOFONI e CAMPANELLI



**art. 7.2000.01**

targa citofono a 1 pulsante 265x130 mm

|          |    |
|----------|----|
| FINITURA | OL |
| IMBALLO  | 1  |

**art. 7.2000.02**

targa citofono a 2 pulsanti 265x130 mm

|          |    |
|----------|----|
| FINITURA | OL |
| IMBALLO  | 1  |

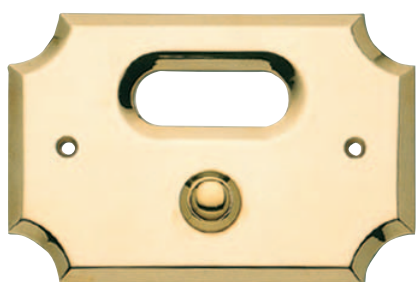

**art. 7.2010.01**

campanello a 1 pulsante 80x120 mm

|          |    |
|----------|----|
| FINITURA | OL |
| IMBALLO  | 2  |

**art. 7.2010.02**

campanello a 2 pulsanti 80x120 mm

|          |    |
|----------|----|
| FINITURA | OL |
| IMBALLO  | 2  |

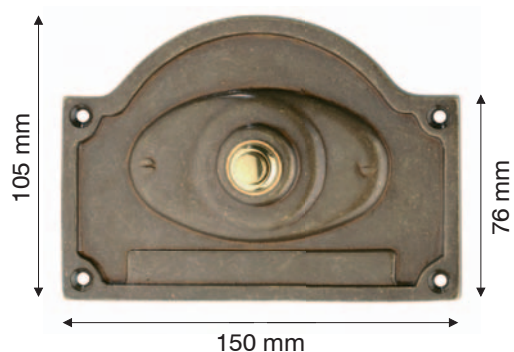

**art. 7.2020**

campanello Country a 1 pulsante

|          |         |
|----------|---------|
| FINITURA | ANT/OLV |
| IMBALLO  | 1       |

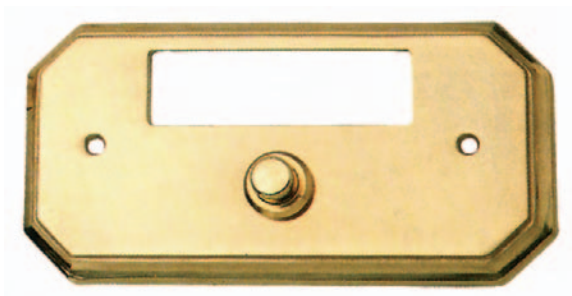

**art. 7.2050**

campanello Silvia a 1 pulsante  
140x72 mm

|          |     |     |
|----------|-----|-----|
| FINITURA | OLV | ANT |
| IMBALLO  | 4   | 4   |

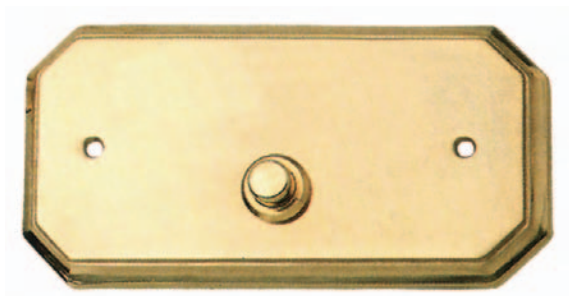

**art. 7.2051**

campanello Silvia senza finestrella  
140x72 mm

|          |     |     |
|----------|-----|-----|
| FINITURA | OLV | ANT |
| IMBALLO  | 4   | 4   |

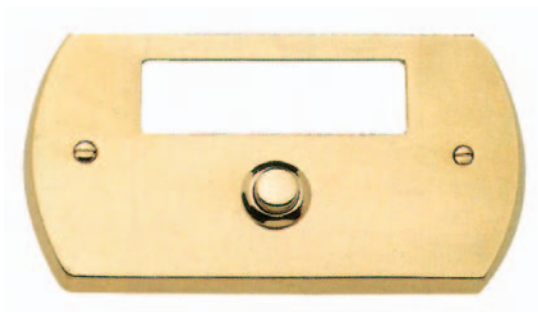

**art. 7.2055**

campanello ovale a 1 pulsante  
132x72 mm

|          |     |     |
|----------|-----|-----|
| FINITURA | OLV | ANT |
| IMBALLO  | 4   | 4   |



**art. 7.2056**

campanello ovale senza finestrella  
132x72 mm

|          |     |     |
|----------|-----|-----|
| FINITURA | OLV | ANT |
| IMBALLO  | 4   | 4   |

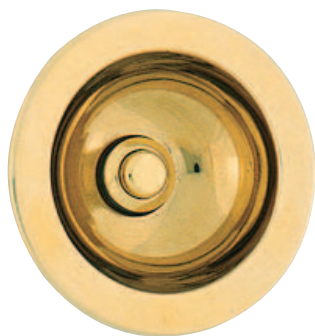

**art. 7.2060**

campanello Classic tondo concavo  
con bordo ø 75 mm

|          |    |
|----------|----|
| FINITURA | OL |
| IMBALLO  | 2  |



**art. 7.2070**

campanello Venezia tondo concavo  
con bordo ø 58 mm

|          |    |
|----------|----|
| FINITURA | OL |
| IMBALLO  | 5  |



**art. 7.2080**

pulsante per campanello  
ø 16x38 mm

|          |     |    |    |
|----------|-----|----|----|
| FINITURA | OLV | BR | CR |
| IMBALLO  | 25  | 25 | 25 |



**art. 7.2090**

campanello Leoncino  
72x70 mm

|          |     |     |
|----------|-----|-----|
| FINITURA | OLV | ANT |
| IMBALLO  | 4   | 4   |



**art. 7.2100**

campanello su rosetta Lux  
ø 45 mm

|          |     |     |
|----------|-----|-----|
| FINITURA | OLV | ANT |
| IMBALLO  | 4   | 4   |



**art. 7.2130**

campanello rosetta ovale rigata  
30x62 mm

|          |     |
|----------|-----|
| FINITURA | OLV |
| IMBALLO  | 5   |

# PLACCHE PORTANOME



## art. 7.0002

placca portanome Classic ovale

|          | 7.0002    | 7.0003    | 7.0004    | 7.0005     | 7.0006     |
|----------|-----------|-----------|-----------|------------|------------|
| MISURA   | 120x60 mm | 140x70 mm | 180x90 mm | 220x130 mm | 330x200 mm |
| FINITURA | OLV       | OLV       | OLV       | OLV        | OLV        |
| IMBALLO  | 10        | 10        | 5         | 2          | 1          |



## art. 7.0010

placca portanome Capri  
ovale bombata, pesante 140x70 mm

|          |     |
|----------|-----|
| FINITURA | OLV |
| IMBALLO  | 10  |



## art. 7.0020

placca portanome Vesuvio  
ovale leggero

|          | 7.0020    | 7.0021   |
|----------|-----------|----------|
| MISURA   | 120x60 mm | 80x40 mm |
| FINITURA | OLV       | OLV      |
| IMBALLO  | 10        | 10       |



## art. 7.0030

placca portanome Ala  
135x50 mm

|          |     |
|----------|-----|
| FINITURA | OLV |
| IMBALLO  | 10  |



## art. 7.0050

placca portanome Trieste  
135x46 mm

|          |     |
|----------|-----|
| FINITURA | OLV |
| IMBALLO  | 10  |

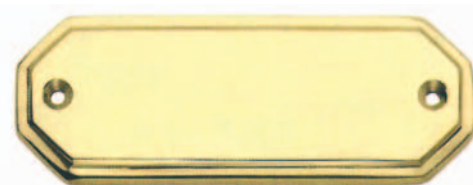

## art. 7.0060

placca portanome Ring  
105x38 mm

|          |     |
|----------|-----|
| FINITURA | OLV |
| IMBALLO  | 10  |

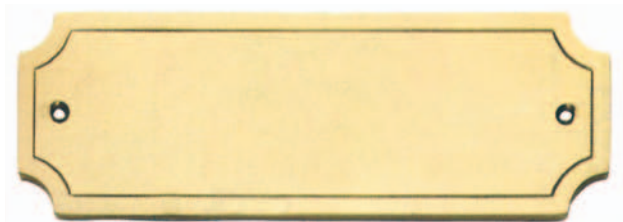

**art. 7.0070**

placca portanome Trento  
170x58 mm

|          |     |
|----------|-----|
| FINITURA | OLV |
| IMBALLO  | 10  |



**art. 7.0100**

placca portanome Star  
110x40 mm

|          |     |
|----------|-----|
| FINITURA | OLV |
| IMBALLO  | 10  |



**art. 7.0110**

placca portanome Todi  
82x46 mm

|          |     |
|----------|-----|
| FINITURA | OLV |
| IMBALLO  | 20  |

513 Serie **TARGHETTE**  
LABORHELLE



**art. 0.0716**

targhetta figura uomo  
100x40 mm

|          |     |
|----------|-----|
| FINITURA | OLV |
| IMBALLO  | 12  |



**art. 0.0717**

targhetta figura donna  
100x40 mm

|          |     |
|----------|-----|
| FINITURA | OLV |
| IMBALLO  | 12  |



**art. 0.0720**

targhetta bagno  
130x40 mm

|          |     |
|----------|-----|
| FINITURA | OLV |
| IMBALLO  | 10  |



**art. 0.0730**

targhetta bagno  
100x50 mm

|          |     |
|----------|-----|
| FINITURA | OLV |
| IMBALLO  | 10  |

# BUCALETTERE

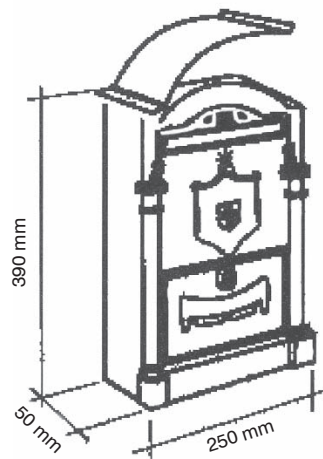

## art. 7.3000

cassetta poste  
390x250x50 mm

|          |     |    |
|----------|-----|----|
| FINITURA | OLV | BR |
| IMBALLO  | 1   | 1  |

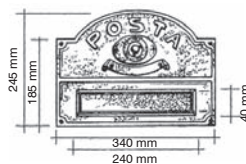

## art. 7.3050

bucallettere serie Florence

|          |    |     |
|----------|----|-----|
| FINITURA | OL | ANT |
| IMBALLO  | 1  | 1   |



## art. 7.3055

sportello da incasso  
286x286 mm

|          |    |     |
|----------|----|-----|
| FINITURA | OL | ANT |
| IMBALLO  | 1  | 1   |



## art. 7.3150

bucallettere Old  
300x130 mm

|          |     |     |
|----------|-----|-----|
| FINITURA | OLV | ANT |
| IMBALLO  | 1   | 1   |



### art. 7.3120

bucallettere Georgian

|          | 7.3120.01 | 7.3120.02 |
|----------|-----------|-----------|
| MISURA   | 254x75 mm | 280x90 mm |
| FINITURA | OLV       | OLV       |
| IMBALLO  | 1         | 1         |



### art. 7.3130

bucallettere Big Gravity Style  
310x80 mm - int. 280x40 mm

|          |      |
|----------|------|
| FINITURA | FUMÈ |
| IMBALLO  | 1    |



### art. 7.3140

bucallettere Victorian

|          | 7.3140.01 | 7.3140.01 | 7.3140.01 | 7.3140.01 |
|----------|-----------|-----------|-----------|-----------|
| MISURA   | 254x75 mm | 254x75 mm | 254x75 mm | 254x75 mm |
| FINITURA | OLV       | OGR       | CR        | CRS       |
| IMBALLO  | 1         | 1         | 1         | 1         |

|          | 7.3140.02  | 7.3140.03  |
|----------|------------|------------|
| MISURA   | 280x100 mm | 300x100 mm |
| FINITURA | OLV        | OLV        |
| IMBALLO  | 1          | 1          |



### art. 7.3145

bucallettere Gravity  
254x75 mm

|          |     |     |    |     |
|----------|-----|-----|----|-----|
| FINITURA | OLV | OGR | CR | CRS |
| IMBALLO  | 1   | 1   | 1  | 1   |



### art. 7.3147

bucallettere Big Gravity  
310x80 mm - int. 280x40 mm

|          |     |     |     |
|----------|-----|-----|-----|
| FINITURA | OLV | OGR | SAT |
| IMBALLO  | 1   | 1   | 1   |



**art. 7.3160**

bucal lettere  
254X75 mm

|          |         |        |
|----------|---------|--------|
| FINITURA | OLV/SAT | NR/SAT |
| IMBALLO  | 1       | 1      |



**art. 7.3170**

bucal lettere  
350X90 mm

|          |          |
|----------|----------|
| FINITURA | FERRO NR |
| IMBALLO  | 1        |



**art. 7.3180**

bucal lettere Queen  
275x80 mm - int. 210x40 mm

|          |     |     |    |     |
|----------|-----|-----|----|-----|
| FINITURA | OLV | OGR | CR | CRS |
| IMBALLO  | 1   | 1   | 1  | 1   |



**art. 7.3185**

bucal lettere King  
275x80 mm - int. 210x40 mm

|          |     |     |     |     |
|----------|-----|-----|-----|-----|
| FINITURA | OLV | ANT | OGR | CRS |
| IMBALLO  | 1   | 1   | 1   | 1   |

# BASE PER NUMERI

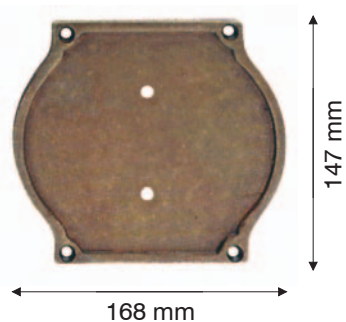

**art. 9.1050.01**

base per 1 numero

|          |     |
|----------|-----|
| FINITURA | ANT |
| IMBALLO  | 2   |

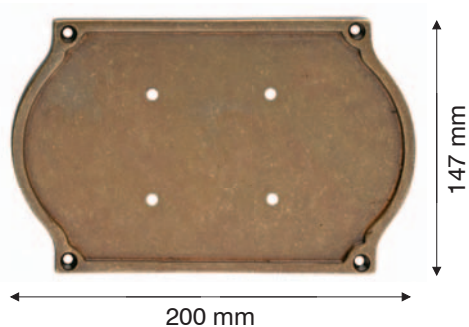

**art. 9.1050.02**

base per 2 numeri

|          |     |
|----------|-----|
| FINITURA | ANT |
| IMBALLO  | 2   |

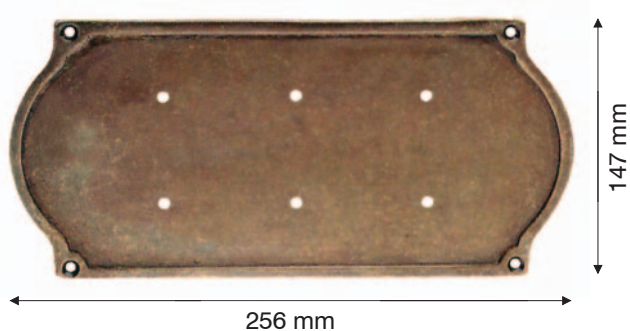

**art. 9.1050.03**

base per 3 numeri

|          |     |
|----------|-----|
| FINITURA | ANT |
| IMBALLO  | 2   |

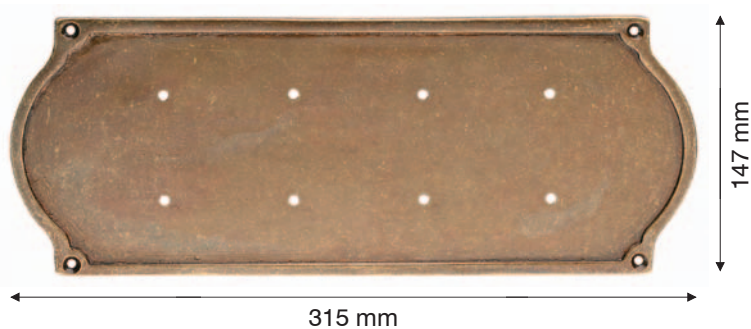

**art. 9.1050.04**

base per 4 numeri

|          |     |
|----------|-----|
| FINITURA | ANT |
| IMBALLO  | 2   |



**art. 9.1060**

numero civico Lux  
78x60 mm

|          |         |
|----------|---------|
| FINITURA | ANT/OLV |
| IMBALLO  | 4       |



serie **NUMERI e LETTERE**



**art. 9.0910**  
lettere - alfabeto completo  
50 mm con pioli

|          |     |
|----------|-----|
| FINITURA | OLV |
| IMBALLO  | 10  |



**art. 9.0915**  
numero civico  
50 mm con pioli

|          |     |
|----------|-----|
| FINITURA | OLV |
| IMBALLO  | 10  |



**art. 9.0920**  
numero civico  
125 mm con fori

|          |     |
|----------|-----|
| FINITURA | OLV |
| IMBALLO  | 10  |

**art. 9.0930**  
numero civico  
50 mm con fori

|          |     |
|----------|-----|
| FINITURA | OLV |
| IMBALLO  | 10  |



**art. 9.0940**  
numero civico  
150 mm con chiodo filettato 5 ma e tassello

|          |     |
|----------|-----|
| FINITURA | OLV |
| IMBALLO  | 10  |

**art. 9.0945**  
numero civico  
100 mm con chiodo filettato 5 ma e tassello

|          |     |
|----------|-----|
| FINITURA | OLV |
| IMBALLO  | 10  |



**art. 9.0948**

lettere - solo A B C D  
50 mm

|          |          |
|----------|----------|
| FINITURA | FERRO NR |
| IMBALLO  | 10       |
| EURO     | 2,80     |

**art. 9.0950**

numero civico con fori  
75 mm

|          |          |
|----------|----------|
| FINITURA | FERRO NR |
| IMBALLO  | 10       |
| EURO     | 2,80     |



**art. 9.0960**

numero civico inglese  
75 mm con fori

|          |     |
|----------|-----|
| FINITURA | OLV |
| IMBALLO  | 10  |

**art. 9.0980**

numero civico martellato  
110 mm

|          |        |
|----------|--------|
| FINITURA | NR/ORO |
| IMBALLO  | 10     |



**art. 9.0990**

numero civico gotico  
120 mm

|          |      |
|----------|------|
| FINITURA | FUMÈ |
| IMBALLO  | 10   |



# serie COPRIAVVOLGIBILI



**art. 4.9505**  
copriavvolgibile Rettangolare  
278x56 mm

|          |     |     |     |
|----------|-----|-----|-----|
| FINITURA | OLV | OGR | CRS |
| IMBALLO  | 12  | 12  | 12  |



**art. 4.9510**  
copriavvolgibile Eko  
240x53 mm

|          |     |     |     |    |
|----------|-----|-----|-----|----|
| FINITURA | OLV | OGR | CRS | BN |
| IMBALLO  | 12  | 12  | 12  | 12 |



**art. 4.9520**  
copriavvolgibile Silvia  
278x54 mm

|          |     |     |     |
|----------|-----|-----|-----|
| FINITURA | OLV | OGR | CRS |
| IMBALLO  | 12  | 12  | 12  |



**art. 4.9530**  
copriavvolgibile Classic  
278x56 mm

|          |     |     |     |    |
|----------|-----|-----|-----|----|
| FINITURA | OLV | OGR | CRS | BN |
| IMBALLO  | 12  | 12  | 12  | 12 |



**art. 4.9540**

copriavvolgibile Flora  
280x57 mm

|          |    |
|----------|----|
| FINITURA | BR |
| IMBALLO  | 14 |



**art. 4.9550**

copriavvolgibile Barocco  
280x57 mm

|          |    |
|----------|----|
| FINITURA | BR |
| IMBALLO  | 14 |



**art. 2.0030**

placca cieca 278x 56 mm  
copriautomazione per tapparelle

|          |     |     |     |
|----------|-----|-----|-----|
| FINITURA | OLV | OGR | CRS |
| IMBALLO  | 12  | 12  | 12  |

# SCORRICINGHIA



**art. 4.2314**

scorricinghia Ovale  
35x60 mm

|          |     |    |     |    |
|----------|-----|----|-----|----|
| FINITURA | OLV | BR | CRS | BN |
| IMBALLO  | 24  | 24 | 24  | 24 |



**art. 4.2315**

scorricinghia Rettangolare  
60x45 mm

|          |     |    |     |    |
|----------|-----|----|-----|----|
| FINITURA | OLV | BR | CRS | BN |
| IMBALLO  | 24  | 24 | 24  | 24 |



**art. 4.2316**

scorricinghia Lusso  
62x52 mm

|          |     |    |     |    |
|----------|-----|----|-----|----|
| FINITURA | OLV | BR | CRS | BN |
| IMBALLO  | 24  | 24 | 24  | 24 |



**art. 4.2317**

scorricinghia Silvia  
60x45 mm

|          |     |    |
|----------|-----|----|
| FINITURA | OLV | BR |
| IMBALLO  | 24  | 24 |



# 3in1 Serie COPRINTERRUTTORI

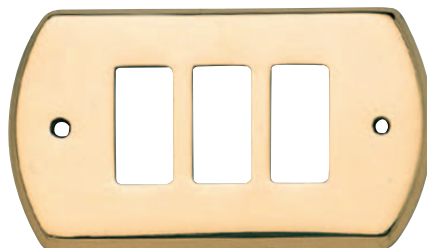
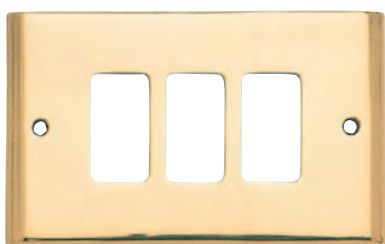

## art. 8.2000

coprinterruttore Ibiza 125x74 mm

8.2000.00 8.2000.01-02-03 8.2000.04-05

|          |       |       |     |
|----------|-------|-------|-----|
| N° FORI  | cieco | 1-2-3 | 4-5 |
| FINITURA | OLV   | OLV   | OLV |
| IMBALLO  | 10    | 10    | 10  |
| FINITURA | OGR   | OGR   | OGR |
| FINITURA | CRS   | CRS   | CRS |

## art. 8.2030

coprinterruttore Classic 132x72 mm

8.2030.00 8.2030.01-02-03 8.2030.04-05

|          |       |       |     |
|----------|-------|-------|-----|
| N° FORI  | cieco | 1-2-3 | 4-5 |
| FINITURA | OLV   | OLV   | OLV |
| IMBALLO  | 10    | 10    | 10  |
| FINITURA | OGR   | OGR   | OGR |
| FINITURA | CRS   | CRS   | CRS |

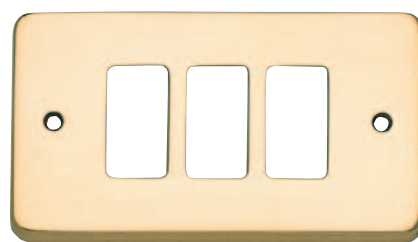
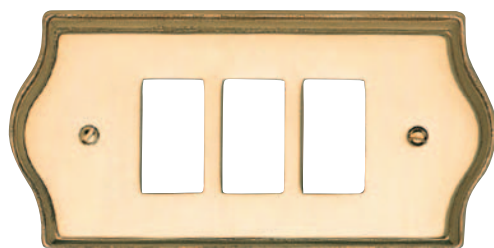

## art. 8.2060

coprinterruttore Venezia 145x73 mm

8.2060.01-02-03 8.2060.01-02-03

|          |       |       |
|----------|-------|-------|
| N° FORI  | 1-2-3 | 1-2-3 |
| FINITURA | OLV   | ANT   |
| IMBALLO  | 10    | 10    |

## art. 8.2090

coprinterruttore Praga 124x70 mm

8.2090.01-02-03 8.2090.04-05

|          |       |     |
|----------|-------|-----|
| N° FORI  | 1-2-3 | 4-5 |
| FINITURA | OLV   | OLV |
| IMBALLO  | 10    | 10  |
| FINITURA | OGR   | OGR |
| FINITURA | CRS   | CRS |



**art. 8.2180**

coprinterruttore 212 - 135x73 mm

|          |       |
|----------|-------|
| N° FORI  | 1-2-3 |
| FINITURA | FUMÈ  |
| IMBALLO  | 10    |



**art. 8.2220**

coprinterruttore Giulia 135x72 mm

|          |       |
|----------|-------|
| N° FORI  | 1-2-3 |
| FINITURA | PBN   |
| IMBALLO  | 10    |

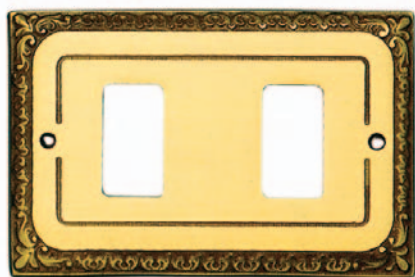

**art. 8.2240**

coprinterruttore 211 - 124x75 mm

|          |       |
|----------|-------|
| N° FORI  | 1-2-3 |
| FINITURA | FUMÈ  |
| IMBALLO  | 10    |



**art. 8.2480**

coprinterruttore Silvia 140x72 mm

|          |           |                 |
|----------|-----------|-----------------|
|          | 8.2480.00 | 8.2480.01-02-03 |
| N° FORI  | cieco     | 1-2-3           |
| FINITURA | OLV       | OLV             |
| IMBALLO  | 10        | 10              |
| FINITURA | ANT       | ANT             |



**art. 5.4230**

catenaccio orizzontale per spagnolette base 38x13 con incontro

|          |                    |
|----------|--------------------|
|          | 5.4230.20          |
| MISURA   | 200 mm             |
| FINITURA | OTT. VERNICIATO NR |
| IMBALLO  | 4                  |



### art. 5.4030

catenaccio binario

|          | 5.4030.06 | 5.4030.08 | 5.4030.10 | 5.4030.12 |
|----------|-----------|-----------|-----------|-----------|
| MISURA   | 60 mm     | 80 mm     | 100 mm    | 120 mm    |
| FINITURA | OL        | OL        | OL        | OL        |
| IMBALLO  | 50        | 50        | 50        | 50        |

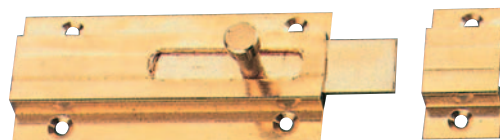

### art. 5.4050

catenaccio sagomato leggero con incontro

|          | 5.4050.05 | 5.4050.06 | 5.4050.08 |
|----------|-----------|-----------|-----------|
| MISURA   | 50 mm     | 60 mm     | 80 mm     |
| FINITURA | OL        | OL        | OL        |
| IMBALLO  | 24        | 24        | 24        |

|          | 5.4050.10 | 5.4050.12 | 5.4050.14 | 5.4050.16 |
|----------|-----------|-----------|-----------|-----------|
| MISURA   | 100 mm    | 120 mm    | 140 mm    | 160 mm    |
| FINITURA | OL        | OL        | OL        | OL        |
| IMBALLO  | 24        | 24        | 24        | 24        |

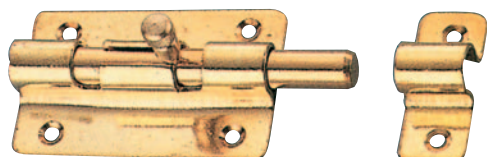

### art. 5.4060

catenaccio a cannone con incontro

|          | 5.4060.06 | 5.4060.08 | 5.4060.10 | 5.4060.12 |
|----------|-----------|-----------|-----------|-----------|
| MISURA   | 60 mm     | 80 mm     | 100 mm    | 120 mm    |
| FINITURA | OL        | OL        | OL        | OL        |
| IMBALLO  | 24        | 24        | 24        | 24        |



### art. 5.4065

catenaccio a cannone base quadra

|          | 5.4065.06 | 5.4065.07 | 5.4065.09 |
|----------|-----------|-----------|-----------|
| MISURA   | 60 mm     | 75 mm     | 90 mm     |
| FINITURA | OLV       | OLV       | OLV       |
| IMBALLO  | 12        | 12        | 12        |



### art. 5.4075

catenaccio a cannone rigato con incontro

|          | 5.4075.06 | 5.4075.07 | 5.4075.10 | 5.4075.15 |
|----------|-----------|-----------|-----------|-----------|
| MISURA   | 60x19 mm  | 75x19 mm  | 100x25 mm | 150x38 mm |
| FINITURA | OLV       | OLV       | OLV       | OLV       |
| IMBALLO  | 24        | 24        | 12        | 6         |

|          |    |    |    |    |
|----------|----|----|----|----|
| FINITURA | CR | CR | CR | CR |
|----------|----|----|----|----|



### art. 5.4080

catenaccio tondo con molla

|          | 5.4080.06 | 5.4080.08 | 5.4080.10 | 5.4080.12 |
|----------|-----------|-----------|-----------|-----------|
| MISURA   | 60 mm     | 80 mm     | 100 mm    | 120 mm    |
| FINITURA | OL        | OL        | OL        | OL        |
| IMBALLO  | 12        | 12        | 12        | 12        |



### art. 5.4070

catenaccio a binario Lux con incontro

|          | 5.4070.06 | 5.4070.07 |
|----------|-----------|-----------|
| MISURA   | 60 mm     | 75 mm     |
| FINITURA | OLV       | OLV       |
| IMBALLO  | 12        | 12        |

|          | 5.4070.10 | 5.4070.12 | 5.4070.15 |
|----------|-----------|-----------|-----------|
| MISURA   | 100 mm    | 120 mm    | 150 mm    |
| FINITURA | OLV       | OLV       | OLV       |
| IMBALLO  | 12        | 12        | 12        |



### art. 5.4110

catenaccio Victoria con incontro

|          | 5.4110.15 | 5.4110.20 |
|----------|-----------|-----------|
| MISURA   | 150 mm    | 200 mm    |
| FINITURA | OLV       | OLV       |
| IMBALLO  | 12        | 12        |

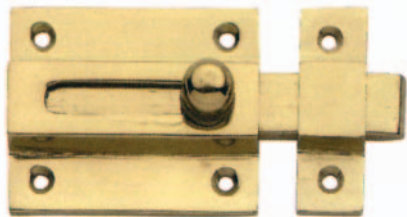

### art. 5.4170

catenaccio con chiavistello lungo

|          | 5.4170.08 |
|----------|-----------|
| MISURA   | 80 mm     |
| FINITURA | OLV       |
| IMBALLO  | 12        |



### art. 5.4180

catenaccio Rustico in ferro

|          | 5.4180.15 | 5.4180.20 |
|----------|-----------|-----------|
| MISURA   | 150 mm    | 200 mm    |
| FINITURA | NR        | NR        |
| IMBALLO  | 12        | 12        |



### art. 5.4190

catenaccio Flora

|          | 5.4190.15 | 5.4190.20 |
|----------|-----------|-----------|
| MISURA   | 150 mm    | 200 mm    |
| FINITURA | BR        | BR        |
| IMBALLO  | 12        | 12        |

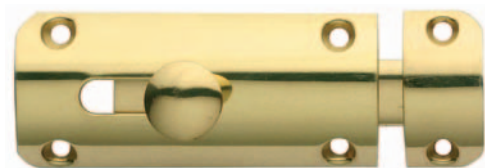

### art. 5.4270

catenaccio Flat con incontro

|          | 5.4270.05 | 5.4270.06 | 5.4270.08 | 5.4270.10 |
|----------|-----------|-----------|-----------|-----------|
| MISURA   | 50 mm     | 60 mm     | 80 mm     | 100 mm    |
| FINITURA | OLV       | OLV       | OLV       | OLV       |
| IMBALLO  | 12        | 12        | 12        | 12        |
| FINITURA | CR        | CR        | CR        | CR        |



### art. 5.4010

catenaccio verticale

|          | 5.4010.20 | 5.4010.25 |
|----------|-----------|-----------|
| MISURA   | 200 mm    | 250 mm    |
| FINITURA | OLV       | OLV       |
| IMBALLO  | 12        | 12        |

|          | 5.4010.30 | 5.4010.40 | 5.4010.50 |
|----------|-----------|-----------|-----------|
| MISURA   | 300 mm    | 400 mm    | 500 mm    |
| FINITURA | OLV       | OLV       | OLV       |
| IMBALLO  | 12        | 12        | 12        |



### art. 5.4100

catenaccio orizzontale con incontro

|          | 5.4100.08 | 5.4100.10 | 5.4100.13 |
|----------|-----------|-----------|-----------|
| MISURA   | 80 mm     | 100 mm    | 130 mm    |
| FINITURA | OLV       | OLV       | OLV       |
| IMBALLO  | 12        | 12        | 12        |

|          | 5.4100.17 | 5.4100.20 | 5.4100.25 | 5.4100.30 |
|----------|-----------|-----------|-----------|-----------|
| MISURA   | 170 mm    | 200 mm    | 250 mm    | 300 mm    |
| FINITURA | OLV       | OLV       | OLV       | OLV       |
| IMBALLO  | 12        | 12        | 12        | 12        |



### art. 5.4120

catenaccio verticale a puntale

|          | 5.4120.20 | 5.4120.25 | 5.4120.30 | 5.4120.40 |
|----------|-----------|-----------|-----------|-----------|
| MISURA   | 200 mm    | 250 mm    | 300 mm    | 400 mm    |
| FINITURA | OLV       | OLV       | OLV       | OLV       |
| IMBALLO  | 12        | 12        | 12        | 12        |

### art. 5.4140

catenaccio a incastro

|          | 5.4140.25 | 5.4140.30 | 5.4140.40 |
|----------|-----------|-----------|-----------|
| MISURA   | 250 mm    | 300 mm    | 400 mm    |
| FINITURA | OLV       | OLV       | OLV       |
| IMBALLO  | 12        | 12        | 12        |



### art. 5.4150

catenaccio a ginocchio per persiane

|          | 5.4150.20 | 5.4150.25 | 5.4150.30 | 5.4150.40 |
|----------|-----------|-----------|-----------|-----------|
| MISURA   | 200 mm    | 250 mm    | 300 mm    | 400 mm    |
| FINITURA | OLV       | OLV       | OLV       | OLV       |
| IMBALLO  | 12        | 12        | 12        | 12        |

### art. 5.4160

catenaccio a coda

|          | 5.4160.25 | 5.4160.30 | 5.4160.40 |
|----------|-----------|-----------|-----------|
| MISURA   | 250 mm    | 300 mm    | 400 mm    |
| FINITURA | OLV       | OLV       | OLV       |
| IMBALLO  | 12        | 12        | 12        |

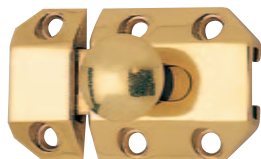

### art. 5.4200

catenaccio sfaccettato con incontro

|          | 5.4200.05 | 5.4200.07 | 5.4200.10 | 5.4200.12 |
|----------|-----------|-----------|-----------|-----------|
| MISURA   | 50 mm     | 75 mm     | 100 mm    | 120 mm    |
| FINITURA | OLV       | OLV       | OLV       | OLV       |
| IMBALLO  | 12        | 12        | 12        | 12        |

|          | 5.4200.15 | 5.4200.20 |
|----------|-----------|-----------|
| MISURA   | 150 mm    | 200 mm    |
| FINITURA | CR        | CR        |
| IMBALLO  | 12        | 12        |

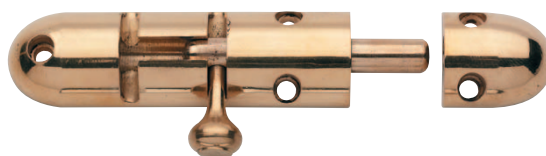

### art. 5.4250

catenaccio Sigaro

|          | 5.4250.10 | 5.4250.15 |
|----------|-----------|-----------|
| MISURA   | 114x22 mm | 152x22 mm |
| FINITURA | OLV       | OLV       |
| IMBALLO  | 12        | 12        |

|          |    |    |
|----------|----|----|
| FINITURA | CR | CR |
|----------|----|----|



### art. 5.4260

catenaccio tubolare con incontro

|          | 5.4260.10 | 5.4260.15 |
|----------|-----------|-----------|
| MISURA   | 100 mm    | 150 mm    |
| FINITURA | OLV       | OLV       |
| IMBALLO  | 12        | 12        |

|          |     |     |
|----------|-----|-----|
| FINITURA | OGR | OGR |
|----------|-----|-----|

|          |    |    |
|----------|----|----|
| FINITURA | CR | CR |
|----------|----|----|

|          |     |     |
|----------|-----|-----|
| FINITURA | CRS | CRS |
|----------|-----|-----|



### art. 5.4300

catenaccio sfaccettato con incontro

|          | 5.4300.12 | 5.4300.15 | 5.4300.20 |
|----------|-----------|-----------|-----------|
| MISURA   | 120 mm    | 150 mm    | 200 mm    |
| FINITURA | OLV       | OLV       | OLV       |
| IMBALLO  | 12        | 12        | 12        |

|          | 5.4300.25 | 5.4300.30 |
|----------|-----------|-----------|
| MISURA   | 250 mm    | 300 mm    |
| FINITURA | OLV       | OLV       |
| IMBALLO  | 12        | 6         |



### art. 5.4350

catenaccio triangolo 110 mm (95+15 mm)

|          |        |        |
|----------|--------|--------|
| MISURA   | 110 mm | 110 mm |
| FINITURA | OLV    | CR     |
| IMBALLO  | 12     | 12     |



### art. 9.0013

catenaccio a cremagliera

|          | 9.0013.08 | 9.0013.10 |
|----------|-----------|-----------|
| MISURA   | 80 mm     | 100 mm    |
| FINITURA | OLV       | OLV       |
| IMBALLO  | 2         | 2         |



### art. 5.4210

catenaccio orizzontale stretto  
con viti a scomparsa con incontro

|          | 5.4210.15 | 5.4210.20 | 5.4210.25 | 5.4210.30 |
|----------|-----------|-----------|-----------|-----------|
| MISURA   | 150 mm    | 200 mm    | 250 mm    | 300 mm    |
| FINITURA | OLV       | OLV       | OLV       | OLV       |
| IMBALLO  | 6         | 6         | 6         | 6         |
| FINITURA | BR        | BR        | BR        | BR        |
| FINITURA | CR e CRS  | CR e CRS  | CR e CRS  | CR e CRS  |



### art. 5.4220

catenaccio orizzontale stretto  
con viti a scomparsa con incontro

|          | 5.4220.20 | 5.4220.25 | 5.4220.30 | 5.4220.40 |
|----------|-----------|-----------|-----------|-----------|
| MISURA   | 200 mm    | 250 mm    | 300 mm    | 400 mm    |
| FINITURA | OLV       | OLV       | OLV       | OLV       |
| IMBALLO  | 6         | 6         | 6         | 6         |
| FINITURA | BR        | BR        | BR        | BR        |
| FINITURA | CR e CRS  | CR e CRS  | CR e CRS  | CR e CRS  |



### art. 5.4240

catenaccio America bivalente con incontro A+B

|          | 5.4240.10 | 5.4240.15 | 5.4240.20 |           |
|----------|-----------|-----------|-----------|-----------|
| MISURA   | 100 mm    | 150 mm    | 200 mm    |           |
| FINITURA | OLV       | OLV       | OLV       |           |
| IMBALLO  | 6         | 6         | 6         |           |
|          | 5.4240.25 | 5.4240.30 | 5.4240.40 | 5.4240.60 |
| MISURA   | 250 mm    | 300 mm    | 400 mm    | 600 mm    |
| FINITURA | OLV       | OLV       | OLV       | OLV       |
| IMBALLO  | 6         | 6         | 6         | 6         |



### art. 6.0015.00

extra per incontro tipo C per catenaccio America

|          |          |
|----------|----------|
| MISURA   | 34x29 mm |
| FINITURA | OLV      |
| IMBALLO  | 12       |

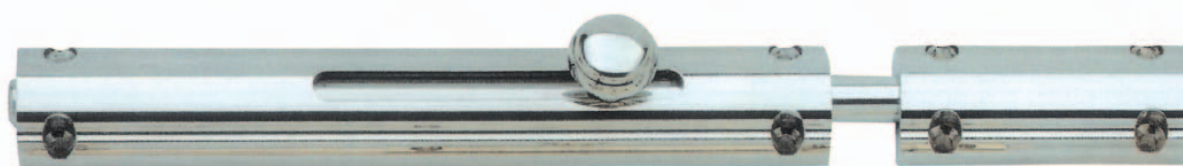

### art. 5.4280

catenaccio orizzontale tondo con incontro

|          | 5.4280.15 | 5.4280.20 | 5.4280.25 | 5.4280.30 |
|----------|-----------|-----------|-----------|-----------|
| MISURA   | 150 mm    | 200 mm    | 250 mm    | 300 mm    |
| FINITURA | OLV       | OLV       | OLV       | OLV       |
| IMBALLO  | 4         | 4         | 4         | 4         |
| FINITURA | OGR       | OGR       | OGR       | OGR       |
| FINITURA | CRS       | CRS       | CRS       | CRS       |

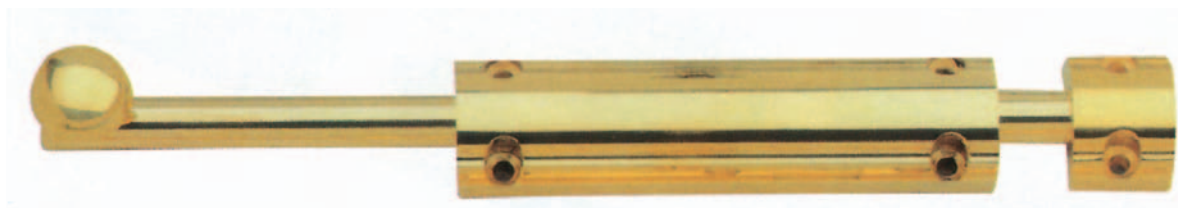

INC A



INC B

### art. 5.4290

catenaccio verticale tondo base 33x13 mm + incontro A o B

|          | 5.4290.20 | 5.4290.25 | 5.4290.30 | 5.4290.40 | INC A | INC B |
|----------|-----------|-----------|-----------|-----------|-------|-------|
| MISURA   | 200 mm    | 250 mm    | 300 mm    | 400 mm    | INC A | INC B |
| FINITURA | OLV       | OLV       | OLV       | OLV       | OLV   | OLV   |
| IMBALLO  | 4         | 4         | 4         | 4         | 4     | 4     |
| FINITURA | OGR       | OGR       | OGR       | OGR       | OGR   | OGR   |
| FINITURA | CRS       | CRS       | CRS       | CRS       | CRS   | CRS   |



### art. 5.4360

catenaccio orizzontale tondo con incontro

|          | 5.4360.15 | 5.4360.20 | 5.4360.25 | 5.4360.30 | 5.4360.40 |
|----------|-----------|-----------|-----------|-----------|-----------|
| MISURA   | 150 mm    | 200 mm    | 250 mm    | 300 mm    | 400 mm    |
| FINITURA | OLV       | OLV       | OLV       | OLV       | OLV       |
| IMBALLO  | 6         | 6         | 6         | 6         | 6         |
| FINITURA | BR        | BR        | BR        | BR        | BR        |
| FINITURA | CR e CRS  | CR e CRS  | CR e CRS  | CR e CRS  | CR e CRS  |



### art. 5.4370

catenaccio verticale tondo con incontro

|          | 5.4370.20 | 5.4370.25 | 5.4370.30 | 5.4370.40 | 5.4370.50 | 5.4370.60 |
|----------|-----------|-----------|-----------|-----------|-----------|-----------|
| MISURA   | 200 mm    | 250 mm    | 300 mm    | 400 mm    | 500 mm    | 600 mm    |
| FINITURA | OLV       | OLV       | OLV       | OLV       | OLV       | OLV       |
| IMBALLO  | 6         | 6         | 6         | 6         | 6         | 6         |
| FINITURA | BR        | BR        | BR        | BR        | BR        | BR        |
| FINITURA | CR e CRS  | CR e CRS  | CR e CRS  | CR e CRS  | CR e CRS  | CR e CRS  |

# CHIAVISTELLI



## art. 5.4175

chiavistello wc  
con visualizzatore L/o rosso/verde 88x38 mm

|          |     |    |
|----------|-----|----|
| FINITURA | OLV | CR |
| IMBALLO  | 5   | 5  |

## art. 6.0190

mini chiavistello

|          |     |    |
|----------|-----|----|
| FINITURA | OLV | CR |
| IMBALLO  | 30  | 30 |

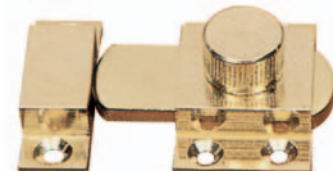
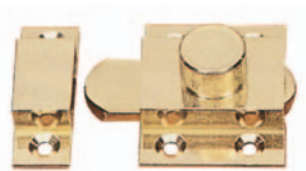

## art. 6.0195

chiavistello con bordo  
40x45 mm

|          |     |
|----------|-----|
| FINITURA | OLV |
| IMBALLO  | 30  |

## art. 6.0220

chiavistello corto  
per bagno tipo pesante 45x45 mm

|          |     |     |
|----------|-----|-----|
| FINITURA | OLV | NIK |
| IMBALLO  | 24  | 24  |

## art. 6.0290

chiavistello corto  
per bagno tipo leggero 45x35 mm

|          |     |     |
|----------|-----|-----|
| FINITURA | OLV | NIK |
| IMBALLO  | 24  | 24  |

# LUCCHETTI e CHIUDIPIORTA

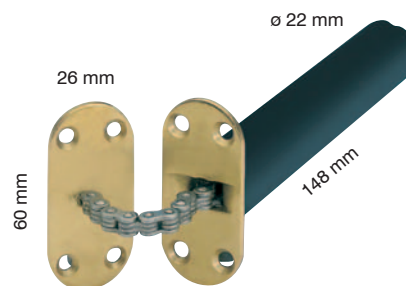

## art. 3.4000

lucchetti in ottone con tre chiavi

|          |           |           |           |           |           |
|----------|-----------|-----------|-----------|-----------|-----------|
|          | 3.4000.02 | 3.4000.03 | 3.4000.04 | 3.4000.05 | 3.4000.06 |
| MISURA   | 20 mm     | 30 mm     | 40 mm     | 50 mm     | 60 mm     |
| FINITURA | OLV       | OLV       | OLV       | OLV       | OLV       |
| IMBALLO  | 12        | 12        | 12        | 12        | 12        |

## art. 6.5050

chiudiporta a scomparsa  
con portata ideale di 50 kg

|          |                     |
|----------|---------------------|
| MISURA   | 60x26x148 - ø 22 mm |
| FINITURA | OLV                 |
| IMBALLO  | 1                   |

# PARACOLPI e FERMAPORTA



## art. 6.0040

paracolpi a chiocciola per porta  
 ø 50 mm - h. 30 mm

|          |     |     |     |    |    |
|----------|-----|-----|-----|----|----|
| FINITURA | OLV | OGR | CRS | BN | NR |
| IMBALLO  | 20  | 20  | 20  | 20 | 20 |

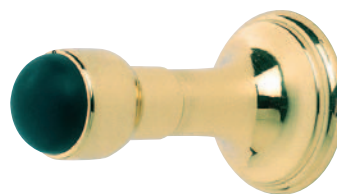

## art. 6.0045

paracolpi a muro  
 ø 40 mm - h. 71 mm

|          |     |
|----------|-----|
| FINITURA | OLV |
| IMBALLO  | 12  |



## art. 6.0900

paracolpi ovale  
 80 mm

|          |     |
|----------|-----|
| FINITURA | OLV |
| IMBALLO  | 6   |



## art. 6.0910

paracolpi ovale  
 40 mm

|          |     |
|----------|-----|
| FINITURA | OLV |
| IMBALLO  | 12  |



## art. 6.0920

paracolpi conchiglia  
 80 mm

|          |     |
|----------|-----|
| FINITURA | OLV |
| IMBALLO  | 12  |



## art. 6.0930

paracolpi universale  
 h. 24 mm - larghezza 38 mm - lunghezza 38 mm

|          |     |    |    |     |    |    |
|----------|-----|----|----|-----|----|----|
| FINITURA | OLV | CR | BZ | NIK | BN | NR |
| IMBALLO  | 20  | 20 | 20 | 20  | 20 | 20 |



## art. 6.0940

paracolpi Cono  
 ø 50 mm - h. 27 mm

|          |     |    |    |     |
|----------|-----|----|----|-----|
| FINITURA | OLV | BZ | CR | CRS |
| IMBALLO  | 25  | 25 | 25 | 25  |



## art. 6.0945

paracolpi Goccia  
 h. 27 mm - larghezza 24 mm - lunghezza 55 mm

|          |     |    |    |     |
|----------|-----|----|----|-----|
| FINITURA | OLV | BZ | CR | CRS |
| IMBALLO  | 25  | 25 | 25 | 25  |

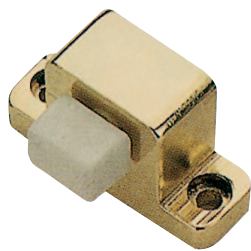

**art. 6.0950**

paracolpi ottone massiccio  
42x25 mm

|          |     |    |  |  |
|----------|-----|----|--|--|
| FINITURA | OLV | BZ |  |  |
| IMBALLO  | 12  | 12 |  |  |



**art. 6.0960**

paracolpi ottone massiccio tipo lusso  
ø 30 mm - h. 45 mm

|          |     |    |     |  |
|----------|-----|----|-----|--|
| FINITURA | OLV | CR | CRS |  |
| IMBALLO  | 12  | 12 | 12  |  |

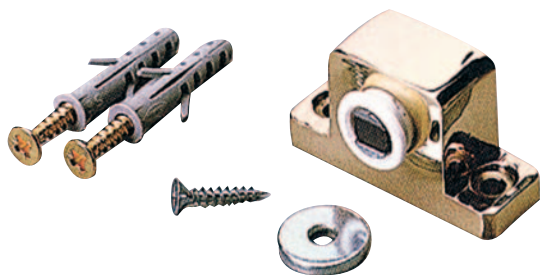

**art. 6.0970**

fermaporta magnetico  
leggero

|          |     |     |  |  |
|----------|-----|-----|--|--|
| FINITURA | OLV | NIK |  |  |
| IMBALLO  | 12  | 12  |  |  |

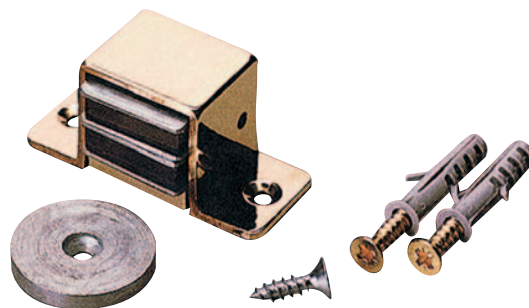

**art. 6.0980**

fermaporta magnetico  
pesante

|          |     |     |  |  |
|----------|-----|-----|--|--|
| FINITURA | OLV | NIK |  |  |
| IMBALLO  | 12  | 12  |  |  |



**art. 6.0999**

paracolpi sferico  
ø 24 mm - h. 28 mm

|          |     |     |    |     |
|----------|-----|-----|----|-----|
| FINITURA | OLV | OGR | CR | CRS |
| IMBALLO  | 25  | 25  | 25 | 25  |



**art. 6.1000**

paracolpi ondulato  
ø 24 mm - h. 22 mm

|          |     |     |    |     |
|----------|-----|-----|----|-----|
| FINITURA | OLV | OGR | CR | CRS |
| IMBALLO  | 25  | 25  | 25 | 25  |

# BLOCCAPERSIANE



## art. 6.0010

gancio fermapersiane

|          | 6.0010.06 | 6.0010.08 | 6.0010.10 | 6.0010.12 | 6.0010.14 | 6.0010.20 |
|----------|-----------|-----------|-----------|-----------|-----------|-----------|
| MISURA   | 60 mm     | 80 mm     | 100 mm    | 120 mm    | 140 mm    | 200 mm    |
| FINITURA | OLV       | OLV       | OLV       | OLV       | OLV       | OLV       |
| IMBALLO  | 25        | 25        | 25        | 25        | 25        | 25        |

|          |    |    |    |    |    |    |
|----------|----|----|----|----|----|----|
| FINITURA | CR | CR | CR | CR | CR | CR |
|----------|----|----|----|----|----|----|

## art. 6.0012

catenaccio fermapersiane multiplo

MISURA da 60 a 140 mm

FINITURA OLV

IMBALLO 20



## art. 6.0170

gancio fermapersiane snodato

|          | 6.0170.05 | 6.0170.07 | 6.0170.10 | 6.0170.12 |
|----------|-----------|-----------|-----------|-----------|
| MISURA   | 50 mm     | 75 mm     | 100 mm    | 125 mm    |
| FINITURA | OLV       | OLV       | OLV       | OLV       |
| IMBALLO  | 20        | 20        | 20        | 20        |

|          | 6.0170.15 | 6.0170.20 | 6.0170.25 | 6.0170.30 |
|----------|-----------|-----------|-----------|-----------|
| MISURA   | 150 mm    | 200 mm    | 250 mm    | 300 mm    |
| FINITURA | OLV       | OLV       | OLV       | OLV       |
| IMBALLO  | 20        | 20        | 20        | 20        |



## art. 6.0180

gancio fermapersiane snodato

|          | 6.0180.10 | 6.0180.15 |
|----------|-----------|-----------|
| MISURA   | 100 mm    | 150 mm    |
| FINITURA | FERRO NR  | FERRO NR  |
| IMBALLO  | 20        | 20        |

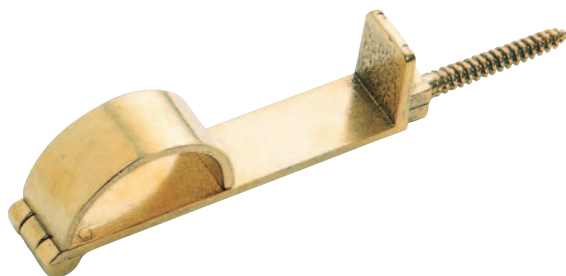

## art. 6.0200

bloccapersiane a incasso 220x50x22 mm

## art. 6.0210

bloccapersiane a vite 150x50x22 mm

|          |    |
|----------|----|
| FINITURA | OL |
| IMBALLO  | 12 |



## art. 6.0250

omino fermapersiane regolabile da 20 a 65 mm

|          |    |
|----------|----|
| FINITURA | OL |
| IMBALLO  | 15 |

# CATENELLE di SICUREZZA



**art. 6.0090**  
gancio Roma

|          |     |    |
|----------|-----|----|
| FINITURA | OLV | BR |
| IMBALLO  | 12  | 12 |



**art. 7.4080**

catenella di sicurezza Napoli leggera 150 mm

|          |    |    |
|----------|----|----|
| FINITURA | OL | BR |
| IMBALLO  | 50 | 50 |

**art. 7.4081**

catenella di sicurezza Napoli pesante 180 mm

|          |    |    |
|----------|----|----|
| FINITURA | OL | BR |
| IMBALLO  | 50 | 50 |



**art. 7.4085**

catenella di sicurezza pesante  
filo ottone ø 2,7 mm

|          |     |     |
|----------|-----|-----|
| FINITURA | OLV | ANT |
| IMBALLO  | 25  | 25  |

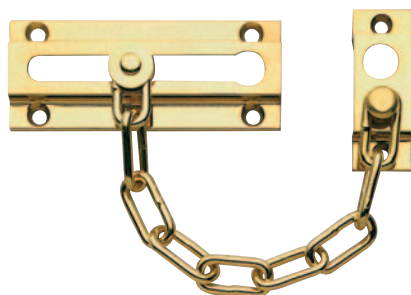

**art. 7.4090**

catenella di sicurezza

|          |     |    |
|----------|-----|----|
| FINITURA | OLV | BR |
| IMBALLO  | 20  | 20 |



**art. 7.4095**

catenella di sicurezza Robur

|          |     |
|----------|-----|
| FINITURA | OLV |
| IMBALLO  | 10  |

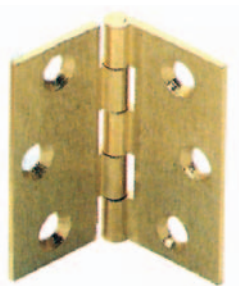

**art. 5.4610**

cerniera fresata piena

|          |          |          |          |          |          |          |
|----------|----------|----------|----------|----------|----------|----------|
| MISURA   | 30x25 mm | 30x30 mm | 35x30 mm | 35x35 mm | 40x30 mm | 40x35 mm |
| FINITURA | SAT      | SAT      | SAT      | SAT      | SAT      | SAT      |
| IMBALLO  | 24       | 24       | 24       | 24       | 24       | 24       |

|          |          |          |          |          |          |          |
|----------|----------|----------|----------|----------|----------|----------|
| MISURA   | 40x40 mm | 50x40 mm | 50x50 mm | 60x50 mm | 70x55 mm | 80x60 mm |
| FINITURA | SAT      | SAT      | SAT      | SAT      | SAT      | SAT      |
| IMBALLO  | 24       | 24       | 24       | 24       | 24       | 24       |



**art. 5.4611**

cerniera mezza zancata

|          |          |          |          |
|----------|----------|----------|----------|
| MISURA   | 35x35 mm | 40x35 mm | 40x40 mm |
| FINITURA | SAT      | SAT      | SAT      |
| IMBALLO  | 24       | 24       | 24       |

|          |          |          |          |
|----------|----------|----------|----------|
| MISURA   | 50x40 mm | 50x50 mm | 60x50 mm |
| FINITURA | SAT      | SAT      | SAT      |
| IMBALLO  | 24       | 24       | 24       |

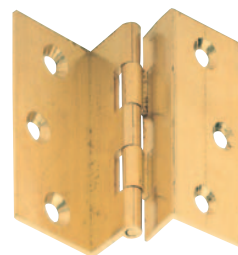

**art. 5.4712**

cerniera doppia zancata

|          |          |          |          |
|----------|----------|----------|----------|
| MISURA   | 35x35 mm | 40x35 mm | 40x40 mm |
| FINITURA | SAT      | SAT      | SAT      |
| IMBALLO  | 24       | 24       | 24       |

|          |          |          |          |          |
|----------|----------|----------|----------|----------|
| MISURA   | 50x40 mm | 50x50 mm | 60x50 mm | 70x55 mm |
| FINITURA | SAT      | SAT      | SAT      | SAT      |
| IMBALLO  | 24       | 24       | 24       | 24       |

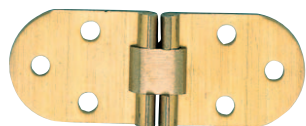

**art. 5.4600**

cerniera Biscotto con fermo 30x80 mm

|          |          |
|----------|----------|
| FINITURA | OTT. SAT |
| IMBALLO  | 24       |

**art. 5.4601**

cerniera Biscotto senza fermo 30x80 mm

|          |          |
|----------|----------|
| FINITURA | OTT. SAT |
| IMBALLO  | 24       |

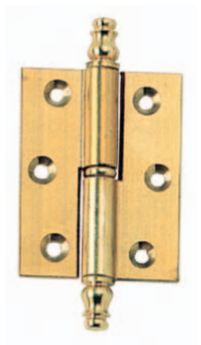

**art. 5.4760 DX**

**art. 5.4761 sx**

cerniera piana con piramide canotto liscio

|          |          |          |          |
|----------|----------|----------|----------|
| MISURA   | 40x40 mm | 50x40 mm | 60x40 mm |
| FINITURA | OL       | OL       | OL       |
| IMBALLO  | 24       | 24       | 24       |

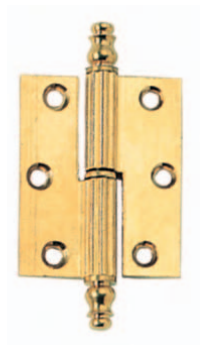

**art. 5.4770 DX**

**art. 5.4771 sx**

cerniera rigata piana con piramide

|          |          |          |          |
|----------|----------|----------|----------|
| MISURA   | 40x40 mm | 50x40 mm | 60x40 mm |
| FINITURA | OL       | OL       | OL       |
| IMBALLO  | 24       | 24       | 24       |



**art. 5.4500 DX**

**art. 5.4501 sx**

cerniera Barocco piccola  
40X35 mm

|          |    |
|----------|----|
| FINITURA | BR |
| IMBALLO  | 24 |

**art. 5.4510 DX**

**art. 5.4511 sx**

cerniera Barocco grande  
50x60 mm

|          |    |
|----------|----|
| FINITURA | BR |
| IMBALLO  | 24 |



**art. 5.4520 DX**

**art. 5.4521 sx**

cerniera Barocco zancata  
40X35 mm

|          |    |
|----------|----|
| FINITURA | BR |
| IMBALLO  | 24 |

**art. 5.4530 DX**

**art. 5.4531 sx**

cerniera Barocco zancata  
50x60 mm

|          |    |
|----------|----|
| FINITURA | BR |
| IMBALLO  | 24 |

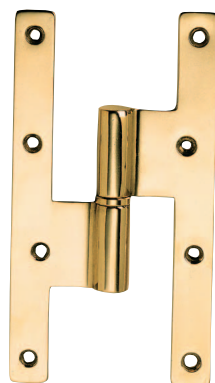

**art. 5.4715 DX**

**art. 5.4716 sx**

cerniera Maschietto

|          |            |            |
|----------|------------|------------|
| MISURA   | 190x100 mm | 190x120 mm |
| FINITURA | OL         | OL         |
| IMBALLO  | 12         | 12         |

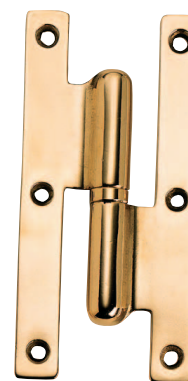

**art. 5.4720 DX**

**art. 5.4721 sx**

cerniera Poumelle

|          |          |           |           |
|----------|----------|-----------|-----------|
| MISURA   | 85x50 mm | 100x55 mm | 100x60 mm |
| FINITURA | OL       | OL        | OL        |
| IMBALLO  | 12       | 12        | 12        |

|          |           |           |           |
|----------|-----------|-----------|-----------|
| MISURA   | 120x60 mm | 120x75 mm | 140x70 mm |
| FINITURA | OL        | OL        | OL        |
| IMBALLO  | 12        | 12        | 12        |

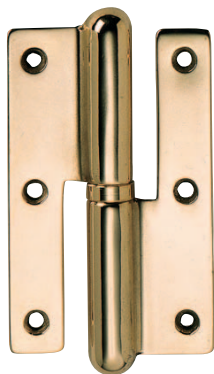

**art. 5.4730 DX**

**art. 5.4731 sx**

cerniera a libro

|          |           |           |           |
|----------|-----------|-----------|-----------|
| MISURA   | 100x65 mm | 120x70 mm | 140x75 mm |
| FINITURA | OL        | OL        | OL        |
| IMBALLO  | 12        | 12        | 12        |



**art. 5.4735 DX**

**art. 5.4736 sx**

cerniera a libro zancata

|          |          |           |
|----------|----------|-----------|
| MISURA   | 10x65 mm | 120x65 mm |
| FINITURA | OL       | OL        |
| IMBALLO  | 12       | 12        |

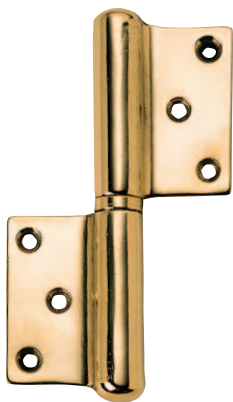

**art. 5.4740 DX**

**art. 5.4741 SX**

cerniera Grossezza

|          |        |        |        |
|----------|--------|--------|--------|
| MISURA   | 100 mm | 120 mm | 140 mm |
| FINITURA | OL     | OL     | OL     |
| IMBALLO  | 12     | 12     | 12     |



**art. 5.4750 DX**

**art. 5.4751 SX**

cerniera per ascensore

|          |       |
|----------|-------|
| MISURA   | 65x80 |
| FINITURA | OL    |
| IMBALLO  | 12    |



smcSerie

# CHIAVI

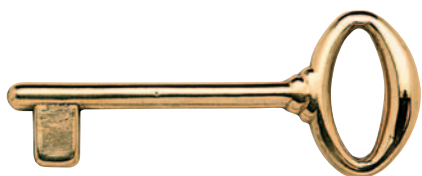

**art. 2.2400**

chiave

|          |     |         |         |
|----------|-----|---------|---------|
| FINITURA | OLV | ANT     | CR      |
| IMBALLO  | 24  | 24      | 24      |
| FINITURA | CRS | ORO ANT | ARG ANT |



**art. 2.2401**

chiave

|          |     |
|----------|-----|
| FINITURA | OLV |
| IMBALLO  | 24  |



**art. 2.2402**

coprichiave scanellato

|          |     |
|----------|-----|
| FINITURA | OLV |
| IMBALLO  | 24  |



**art. 2.2403**

coprichiave tondo

|          |     |
|----------|-----|
| FINITURA | OLV |
| IMBALLO  | 24  |



**art. 2.2420**

chiave

|          |     |     |    |     |
|----------|-----|-----|----|-----|
| FINITURA | OLV | ANT | CR | CRS |
| IMBALLO  | 24  | 24  | 24 | 24  |

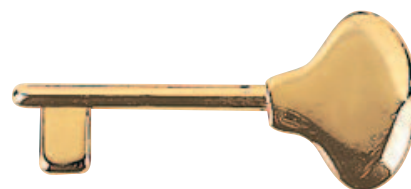

**art. 2.2430**

chiave

|          |     |
|----------|-----|
| FINITURA | OLV |
| IMBALLO  | 24  |

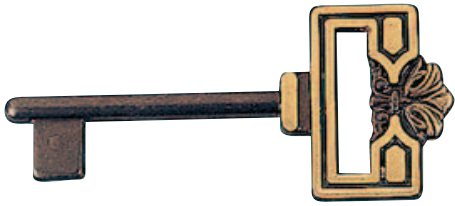

**art. 2.2440**

chiave

|          |    |
|----------|----|
| FINITURA | BR |
| IMBALLO  | 24 |



**art. 2.2460**

chiave

|          |     |     |    |     |
|----------|-----|-----|----|-----|
| FINITURA | OLV | ANT | CR | CRS |
| IMBALLO  | 24  | 24  | 24 | 24  |

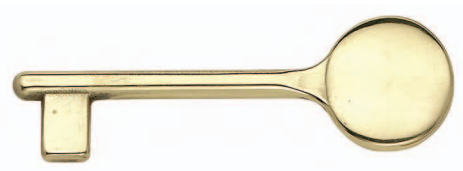

**art. 2.2470**

chiave tonda liscia 90x28 mm

|          |     |    |    |     |
|----------|-----|----|----|-----|
| FINITURA | OLV | BR | CR | CRS |
| IMBALLO  | 24  | 24 | 24 | 24  |

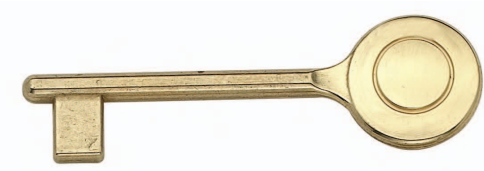

**art. 2.2475**

chiave tonda rigata 90x28 mm

|          |     |    |    |     |
|----------|-----|----|----|-----|
| FINITURA | OLV | BR | CR | CRS |
| IMBALLO  | 24  | 24 | 24 | 24  |



**art. 2.2480**

chiave maschio 100 mm  
con mappa 13x12 mm

|          |          |
|----------|----------|
| FINITURA | FERRO NR |
| IMBALLO  | 50       |



# PORTABITI e GANCI



**art. 3.2400**

portabito Big  
280x140x120 mm

|          |     |     |
|----------|-----|-----|
| FINITURA | OLV | OGR |
| IMBALLO  | 2   | 2   |



**art. 3.2204**

portabito Urano  
ø 60 mm

|          |     |
|----------|-----|
| FINITURA | OLV |
| IMBALLO  | 4   |



**art. 3.2214**

portabito Nettuno  
ø 60 mm

|          |     |
|----------|-----|
| FINITURA | OLV |
| IMBALLO  | 4   |



**art. 3.2234**

portabito Plutone  
ø 60 mm

|          |     |
|----------|-----|
| FINITURA | OLV |
| IMBALLO  | 4   |



**art. 3.2244**

portabito Mercurio  
ø 60 mm

|          |     |
|----------|-----|
| FINITURA | OLV |
| IMBALLO  | 4   |



**art. 3.2320**

portabito Classico

|          |        |       |
|----------|--------|-------|
| FINITURA | Z. OTT | Z. BR |
| IMBALLO  | 12     | 12    |



**art. 3.2330**

portabito Ovale

|          |        |       |
|----------|--------|-------|
| FINITURA | Z. OTT | Z. BR |
| IMBALLO  | 12     | 12    |



**art. 3.2340**

portabito Tondo

|          |        |       |
|----------|--------|-------|
| FINITURA | Z. OTT | Z. BR |
| IMBALLO  | 12     | 12    |



**art. 3.2350**

gancio Marina

|          |     |    |
|----------|-----|----|
| FINITURA | OLV | CR |
| IMBALLO  | 30  | 30 |



**art. 3.2360**

portabito Splendid  
125x70 mm

|          |     |
|----------|-----|
| FINITURA | OLV |
| IMBALLO  | 6   |



**art. 3.2365**

gancio Splendid  
43x70 mm

|          |     |
|----------|-----|
| FINITURA | OLV |
| IMBALLO  | 24  |



**art. 3.2370**

portabito Victorian  
130x60 mm

|          |     |
|----------|-----|
| FINITURA | OLV |
| IMBALLO  | 6   |



**art. 3.2375**

gancio Victorian  
70x60 mm

|          |     |
|----------|-----|
| FINITURA | OLV |
| IMBALLO  | 6   |



**art. 3.2380**

portabito multiplo  
145 mm

|          |     |
|----------|-----|
| FINITURA | OLV |
| IMBALLO  | 10  |



**art. 3.2385**

portabito Rustico  
125x70 mm

|          |          |
|----------|----------|
| FINITURA | FERRO NR |
| IMBALLO  | 12       |



**art. 3.2355**

gancio Rustico  
40x40 mm

|          |          |
|----------|----------|
| FINITURA | FERRO NR |
| IMBALLO  | 24       |



**art. 3.2356**

gancio Rustico 2 posti  
40x100 mm

|          |          |
|----------|----------|
| FINITURA | FERRO NR |
| IMBALLO  | 10       |



**art. 3.2357**

gancio Rustico 3 posti  
40x150 mm

|          |          |
|----------|----------|
| FINITURA | FERRO NR |
| IMBALLO  | 10       |



**art. 3.2390**

portabito Regency  
130x60 mm

|          |     |
|----------|-----|
| FINITURA | OLV |
| IMBALLO  | 6   |



**art. 3.2395**

portabito Regency  
70x60 mm

|          |     |
|----------|-----|
| FINITURA | OLV |
| IMBALLO  | 6   |



**art. 3.2440**

portabito per armadio  
ø 25 mm

|          |     |     |
|----------|-----|-----|
| FINITURA | OLV | OGR |
| IMBALLO  | 20  | 20  |

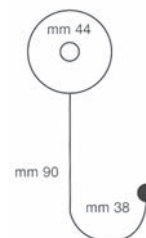

**art. 3.2450**

Base per attaccapanni

|          |     |     |    |     |
|----------|-----|-----|----|-----|
| FINITURA | OLV | ANT | CR | CRS |
| IMBALLO  | 24  | 24  | 24 | 24  |



**art. 3.2455**

portabito Lyl  
39x120 mm

|          |     |
|----------|-----|
| FINITURA | OLV |
| IMBALLO  | 12  |



**art. 3.2456**

portabito Lyl  
39x54 mm

|          |     |
|----------|-----|
| FINITURA | OLV |
| IMBALLO  | 24  |



**art. 3.2460**

portabito Triplex  
85x40x140 mm

| FINITURA | OLV | ANT | CR | CRS |
|----------|-----|-----|----|-----|
| IMBALLO  | 10  | 10  | 10 | 10  |



**art. 3.2491**

portabito a 1 posto

| FINITURA | Z. ORO | Z. BN | Z. CRS |
|----------|--------|-------|--------|
| IMBALLO  | 12     | 12    | 12     |

**art. 3.2492**

portabito a 2 posti

| FINITURA | Z. ORO | Z. BN | Z. CRS |
|----------|--------|-------|--------|
| IMBALLO  | 6      | 6     | 6      |



**art. 3.2493**

portabito a 3 posti

| FINITURA | Z. ORO | Z. BN | Z. CRS |
|----------|--------|-------|--------|
| IMBALLO  | 4      | 4     | 4      |



**art. 3.2496**

portabito singolo  
108x145 mm

| FINITURA | Z. ORO | Z. BN | Z. CRS |
|----------|--------|-------|--------|
| IMBALLO  | 12     | 12    | 12     |



**art. 3.7260**

portabito Star

| FINITURA | Z. LUC | Z. BR | Z. CR | Z. CRS | Z. BN |
|----------|--------|-------|-------|--------|-------|
| IMBALLO  | 12     | 12    | 12    | 12     | 12    |

**art. 3.7210**

portabito Ely  
45x145x55 mm

| FINITURA | OLV | CR | CRS |
|----------|-----|----|-----|
| IMBALLO  | 10  | 10 | 10  |



**art. 3.7200**

gancio Ely  
45x55x55 mm

| FINITURA | OLV | CR | CRS |
|----------|-----|----|-----|
| IMBALLO  | 20  | 20 | 20  |



**art. 3.7220**

gancio doppio Ely  
65x60x40 mm

| FINITURA | OLV | CR | CRS |
|----------|-----|----|-----|
| IMBALLO  | 20  | 20 | 20  |



**art. 3.7230**

gancio Farfalla  
60x38x33

| FINITURA | OLV | OGR | CR | CRS |
|----------|-----|-----|----|-----|
| IMBALLO  | 20  | 20  | 20 | 20  |



**art. 3.7240**

gancio Spirale  
50x95x30 mm

| FINITURA | OLV | OGR | CR | CRS | NR |
|----------|-----|-----|----|-----|----|
| IMBALLO  | 20  | 20  | 20 | 20  | 20 |



**art. 3.7250**

gancio Gun  
40x68x42 mm

| FINITURA | OLV | CR | CRS |
|----------|-----|----|-----|
| IMBALLO  | 20  | 20 | 20  |



**art. 6.1014**

gancio da cucina doppio  
40x19x50 mm

|          |     |     |
|----------|-----|-----|
| FINITURA | OLV | CR  |
| IMBALLO  | 100 | 100 |



**art. 6.1016**

gancio da cucina

|          | 6.1016   | 6.1017   | 6.1018   |
|----------|----------|----------|----------|
| MISURA   | 46x38 mm | 40x30 mm | 34x22 mm |
| FINITURA | OLV      | OLV      | OLV      |
| IMBALLO  | 50       | 100      | 100      |
| FINITURA | CR       | CR       | CR       |



**art. 6.1020**

gancio doppio Big  
42x53x30 mm

|          |     |    |     |
|----------|-----|----|-----|
| FINITURA | OLV | CR | CRS |
| IMBALLO  | 20  | 20 | 20  |



**art. 6.1033**

gancio Luna

|          | 6.1031     | 6.1032     | 6.1033     |
|----------|------------|------------|------------|
| MISURA   | 32x20x6 mm | 29x16x6 mm | 26x14x6 mm |
| FINITURA | OL         | OL         | OL         |
| IMBALLO  | 100        | 100        | 100        |



**art. 6.1059**

gancio per tendaggi leggero  
40x15 mm

|          |     |
|----------|-----|
| FINITURA | OLV |
| IMBALLO  | 100 |



**art. 6.1060**

gancio per tendaggi leggero  
35x14 mm

|          |     |
|----------|-----|
| FINITURA | OLV |
| IMBALLO  | 100 |



**art. 6.1062**

gancio per tendaggi leggero  
30x11 mm

|          |     |
|----------|-----|
| FINITURA | OLV |
| IMBALLO  | 100 |



**art. 6.1063**

gancio per tendaggi leggero  
24x9 mm

|          |     |
|----------|-----|
| FINITURA | OLV |
| IMBALLO  | 100 |



**art. 6.1064**

gancio a cuore

|          | 6.1064     | 6.1065     | 6.1066     |
|----------|------------|------------|------------|
| MISURA   | 40x20x6 mm | 35x16x6 mm | 30x14x6 mm |
| FINITURA | OL         | OL         | OL         |
| IMBALLO  | 100        | 100        | 100        |



**art. 6.1070**

gancio Palma  
70x30x30 mm

|          |     |
|----------|-----|
| FINITURA | OLV |
| IMBALLO  | 50  |



**art. 6.1071**

gancio Palma  
55x30x30 mm

|          |     |
|----------|-----|
| FINITURA | OLV |
| IMBALLO  | 50  |



**art. 6.1072**

gancio Palma  
45x27x20 mm

|          |     |
|----------|-----|
| FINITURA | OLV |
| IMBALLO  | 50  |



**art. 6.1079**

gancio da cucina

|          | 6.1079  | 6.1080  | 6.1081  |
|----------|---------|---------|---------|
| MISURA   | ø 11 mm | ø 16 mm | ø 18 mm |
| FINITURA | OLV     | OLV     | OLV     |
| IMBALLO  | 50      | 100     | 100     |

|          |    |    |    |
|----------|----|----|----|
| FINITURA | BR | BR | BR |
|----------|----|----|----|

|          |    |    |    |
|----------|----|----|----|
| FINITURA | CR | CR | CR |
|----------|----|----|----|

|          |     |     |     |
|----------|-----|-----|-----|
| FINITURA | CRS | CRS | CRS |
|----------|-----|-----|-----|



**art. 6.1090**

gancio Impero

|          |     |
|----------|-----|
| FINITURA | OLV |
| IMBALLO  | 50  |



**art. 6.1102**

gancio per tendaggi Barocco

|          | 6.1102   | 6.1103   | 6.1104   |
|----------|----------|----------|----------|
| MISURA   | 50x45 mm | 30x30 mm | 22x22 mm |
| FINITURA | OL       | OL       | OL       |
| IMBALLO  | 50       | 100      | 100      |



**art. 6.1120**

gancio  
75 mm

|          |     |     |    |
|----------|-----|-----|----|
| FINITURA | OLV | OGR | CR |
| IMBALLO  | 30  | 30  | 30 |



**art. 6.1131**

gancio Fiorentino  
55x25x20 mm

|          |     |
|----------|-----|
| FINITURA | OLV |
| IMBALLO  | 100 |



**art. 6.1132**

gancio Fiorentino  
45x27x17 mm

|          |     |
|----------|-----|
| FINITURA | OLV |
| IMBALLO  | 100 |



**art. 6.1133**

gancio Fiorentino  
33x16x6 mm

|          |     |
|----------|-----|
| FINITURA | OLV |
| IMBALLO  | 100 |



**art. 6.1145**

gancio Tudor

|          |         |
|----------|---------|
| FINITURA | ORO ANT |
| IMBALLO  | 12      |



**art. 6.1146**

gancio per tendaggi con rosetta Barocco  
45x90x65 mm

|          |    |
|----------|----|
| FINITURA | OL |
| IMBALLO  | 25 |



**art. 6.1147**

gancio per tendaggi con rosetta liscia  
45x90x65 mm

|          |    |
|----------|----|
| FINITURA | OL |
| IMBALLO  | 25 |



**art. 6.1149**

gancio per tendaggi pesante  
54x45x26 mm

|          |     |    |    |    |
|----------|-----|----|----|----|
| FINITURA | OLV | BR | NR | CR |
| IMBALLO  | 30  | 30 | 30 | 30 |



**art. 6.1150**

gancio per tendaggi pesante  
47x36x25 mm

|          |     |    |    |    |
|----------|-----|----|----|----|
| FINITURA | OLV | BR | NR | CR |
| IMBALLO  | 30  | 30 | 30 | 30 |



**art. 6.1151**

gancio per tendaggi pesante  
38x33x20 mm

|          |     |    |    |    |
|----------|-----|----|----|----|
| FINITURA | OLV | BR | NR | CR |
| IMBALLO  | 30  | 30 | 30 | 30 |



**art. 6.1152**

gancio per tendaggi pesante  
33x26x15 mm

|          |     |    |    |    |
|----------|-----|----|----|----|
| FINITURA | OLV | BR | NR | CR |
| IMBALLO  | 30  | 30 | 30 | 30 |



**art. 6.1154**

gancio Barocco

|          |               |               |
|----------|---------------|---------------|
|          | <b>6.1154</b> | <b>6.1155</b> |
| MISURA   | 34x20x7 mm    | 16x15x5 mm    |
| FINITURA | OL            | OL            |
| IMBALLO  | 100           | 100           |



**art. 6.1213**

gancio Fiocchetto

|          |     |
|----------|-----|
| FINITURA | OLV |
| IMBALLO  | 50  |



**art. 6.1220**

gancio Cheri  
38x12x17 mm

|          |     |
|----------|-----|
| FINITURA | OLV |
| IMBALLO  | 100 |



**art. 6.1400**

placca rettangolare 5 ganci  
250x45 mm

|          |     |
|----------|-----|
| FINITURA | OLV |
| IMBALLO  | 4   |



**art. 6.1410**

placca tonda 5 ganci  
225x40 mm

|          |     |    |
|----------|-----|----|
| FINITURA | OLV | CR |
| IMBALLO  | 4   | 4  |

# EMBRASSE



## art. 6.1035

embrasse Indy  
30x42x45 mm

|          |     |
|----------|-----|
| FINITURA | OLV |
| IMBALLO  | 30  |



## art. 6.1040

embrasse Corona  
30x90x30 mm

|          |     |
|----------|-----|
| FINITURA | OLV |
| IMBALLO  | 30  |



## art. 6.1041

embrasse Corona piccolo  
20x66x25 mm

|          |     |
|----------|-----|
| FINITURA | OLV |
| IMBALLO  | 30  |



## art. 6.1045

embrasse Flow  
32x32x24 mm

|          |     |
|----------|-----|
| FINITURA | OLV |
| IMBALLO  | 30  |



## art. 6.1050

embrasse Fiore grande  
48x96x30 mm

|          |     |
|----------|-----|
| FINITURA | OLV |
| IMBALLO  | 30  |



## art. 6.1051

embrasse Fiore piccolo  
32x62x24 mm

|          |     |
|----------|-----|
| FINITURA | OLV |
| IMBALLO  | 30  |



## art. 6.1160

embrasse Sole  
80x40x30 mm

|          |     |
|----------|-----|
| FINITURA | OLV |
| IMBALLO  | 30  |



## art. 6.1170

embrasse Luna  
80x40x30 mm

|          |     |
|----------|-----|
| FINITURA | OLV |
| IMBALLO  | 30  |



**art. 6.1180**

embrasse Conchiglia  
65x40x25 mm

|          |      |
|----------|------|
| FINITURA | OLV  |
| IMBALLO  | 30   |
| EURO     | 3,00 |



**art. 6.1190**

embrasse Ancora  
115x55x28 mm

|          |      |
|----------|------|
| FINITURA | OLV  |
| IMBALLO  | 30   |
| EURO     | 3,00 |



**art. 6.1200**

embrasse Edelweiss  
40x20x16 mm

|          |      |
|----------|------|
| FINITURA | OLV  |
| IMBALLO  | 100  |
| EURO     | 1,20 |



**art. 6.1210**

embrasse Fiocco Mini  
46x29x23 mm

|          |      |
|----------|------|
| FINITURA | OLV  |
| IMBALLO  | 50   |
| EURO     | 1,60 |



**art. 6.1211**

embrasse Fiocco Medio  
66x37x27 mm

|          |     |
|----------|-----|
| FINITURA | OLV |
| IMBALLO  | 30  |



**art. 6.1212**

embrasse Fiocco Big  
80x95x40 mm

|          |     |
|----------|-----|
| FINITURA | OLV |
| IMBALLO  | 6   |



**art. 6.1230**

embrasse Pigna  
105x32x30 mm

|          |     |
|----------|-----|
| FINITURA | OLV |
| IMBALLO  | 30  |



**art. 6.1240**

embrasse Cavallo  
110x45x25 mm

|          |     |
|----------|-----|
| FINITURA | OLV |
| IMBALLO  | 30  |



**art. 6.1250**

embrasse Shanghai  
105x32x30 mm

|          |     |
|----------|-----|
| FINITURA | OLV |
| IMBALLO  | 30  |



**art. 6.1261**

embrasse Serpente  
35x35 mm

|          |     |
|----------|-----|
| FINITURA | OLV |
| IMBALLO  | 30  |



**art. 6.1270**

embrasse Ottagonale  
35x50 mm

|          |     |
|----------|-----|
| FINITURA | OLV |
| IMBALLO  | 30  |



**art. 6.1340**

embrasse Rosa  
95x55x35 mm

|          |     |
|----------|-----|
| FINITURA | OLV |
| IMBALLO  | 30  |



**art. 6.1350**

embrasse Girasole  
85x50x23 mm

|          |     |
|----------|-----|
| FINITURA | OLV |
| IMBALLO  | 30  |



**art. 6.1360**

embrasse Cigno

|          |     |    |
|----------|-----|----|
| FINITURA | OLV | CR |
| IMBALLO  | 30  | 30 |



**art. 6.1370**

embrasse nero con terminali  
64x28 ø10 mm

|          |     |    |    |     |
|----------|-----|----|----|-----|
| FINITURA | OLV | BR | CR | CRS |
| IMBALLO  | 30  | 30 | 30 | 30  |



**art. 6.1380**

embrasse Lily  
85x45x27 mm

|          |     |
|----------|-----|
| FINITURA | OLV |
| IMBALLO  | 30  |



**art. 6.1390**

embrasse Giglio con sfera  
55x25x20 mm

|          |     |
|----------|-----|
| FINITURA | OLV |
| IMBALLO  | 30  |



**art. 7.4800**

embrasse liscio  
 ø 65 - 110 mm

|          |     |
|----------|-----|
| FINITURA | OLV |
| IMBALLO  | 6   |

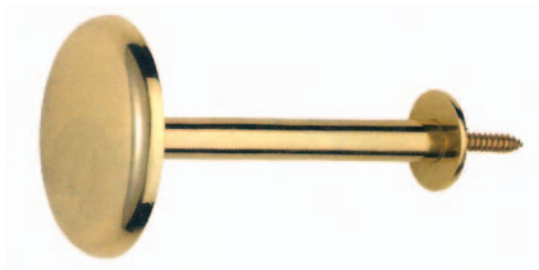

**art. 7.4805**

embrasse liscio  
 ø 60 - 90 mm

|          |     |
|----------|-----|
| FINITURA | OLV |
| IMBALLO  | 10  |

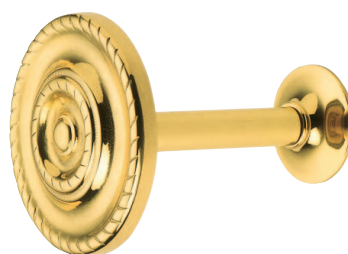

**art. 7.4810**

embrasse Style  
 ø 78 - 110 mm

|          |     |
|----------|-----|
| FINITURA | OLV |
| IMBALLO  | 50  |

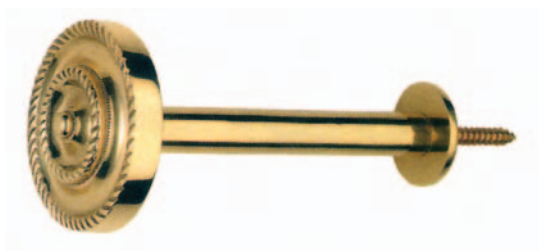

**art. 7.4815**

embrasse Style  
 ø 50 - 90 mm

|          |     |
|----------|-----|
| FINITURA | OLV |
| IMBALLO  | 30  |



**art. 7.4820**

embrasse Liberty

|          | 7.4820.03 | 7.4820.05 | 7.4820.08 | 7.4820.II | 7.4820.II |
|----------|-----------|-----------|-----------|-----------|-----------|
| MISURA   | 30x30 mm  | 50x35 mm  | 80x40 mm  | 110x45 mm | 150x50 mm |
| FINITURA | OLV       | OLV       | OLV       | OLV       | OLV       |
| IMBALLO  | 30        | 30        | 30        | 30        | 30        |



**art. 7.4830**

embrasse Victorian  
 ø 60 - 110 mm

|          |     |
|----------|-----|
| FINITURA | OLV |
| IMBALLO  | 10  |

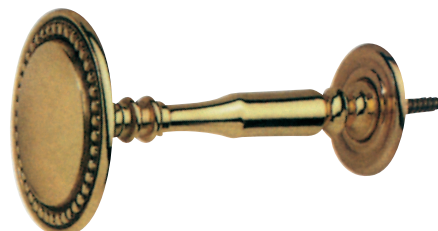

**art. 7.4840**

embrasse Georgian  
 ø 60 - 110 mm

|          |     |
|----------|-----|
| FINITURA | OLV |
| IMBALLO  | 10  |



**art. 7.4850**

embrasse Fiocco  
110 mm

|          |     |
|----------|-----|
| FINITURA | OLV |
| IMBALLO  | 10  |



**art. 7.4880**

embrasse Linea

7.4880.03 7.4880.05 7.4880.08 7.4880.11 7.4880.15

|          |          |          |          |           |           |
|----------|----------|----------|----------|-----------|-----------|
| MISURA   | 30x30 mm | 50x35 mm | 80x40 mm | 110x45 mm | 150x50 mm |
| FINITURA | OLV      | OLV      | OLV      | OLV       | OLV       |
| IMBALLO  | 30       | 30       | 30       | 30        | 30        |



**art. 7.4890**

embrasse Ottagonale

7.4890.10 7.4890.15 7.4890.20 7.4890.25

|          |        |        |        |        |
|----------|--------|--------|--------|--------|
| MISURA   | 100 mm | 150 mm | 200 mm | 250 mm |
| FINITURA | OLV    | OLV    | OLV    | OLV    |
| IMBALLO  | 25     | 25     | 25     | 25     |



**art. 7.4900**

embrasse Flowers  
ø 55 - 90 mm

|          |     |
|----------|-----|
| FINITURA | OLV |
| IMBALLO  | 10  |



**art. 7.4910**

embrasse Cupola  
80x50 mm

|          |     |
|----------|-----|
| FINITURA | OLV |
| IMBALLO  | 10  |

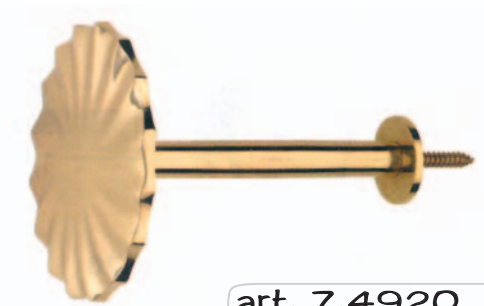

**art. 7.4920**

embrasse Elica  
ø 80 - 100 mm

|          |     |
|----------|-----|
| FINITURA | OLV |
| IMBALLO  | 10  |



**art. 7.4930**

embrasse Tudor  
ø 75 - 80 mm

|          |         |
|----------|---------|
| FINITURA | ORO ANT |
| IMBALLO  | 12      |



**art. 7.4940**

embrasse Stella  
ø 70 - 80 mm

|          |         |
|----------|---------|
| FINITURA | ORO ANT |
| IMBALLO  | 12      |



**art. 6.5410**

maniglia senza foro chiave  
96x46 mm

|          |     |
|----------|-----|
| FINITURA | ANT |
| IMBALLO  | 25  |



**art. 6.5411**

maniglia con foro chiave  
96x46 mm

|          |     |
|----------|-----|
| FINITURA | ANT |
| IMBALLO  | 25  |



**art. 6.5420**

maniglia  
35x59 mm

|          |     |
|----------|-----|
| FINITURA | ANT |
| IMBALLO  | 25  |



**art. 6.5790**

maniglia

|          | 6.5790    | 6.5791    |
|----------|-----------|-----------|
| MISURA   | 167x45 mm | 135x32 mm |
| FINITURA | ANT       | ANT       |
| IMBALLO  | 25        | 25        |



**art. 6.5800**

maniglia ovale a incasso  
112x31 mm - int. 90x120

|          |     |
|----------|-----|
| FINITURA | ANT |
| IMBALLO  | 25  |



**art. 6.5810**

maniglia ovale a incasso  
78x25 mm - int. 58x77

|          |     |
|----------|-----|
| FINITURA | ANT |
| IMBALLO  | 25  |



**art. 6.5820**

maniglia rettangolare a incasso  
39x42 mm - int. ø 24 mm

|          |     |
|----------|-----|
| FINITURA | ANT |
| IMBALLO  | 25  |



**art. 6.5835**

maniglia floreale  
115x35 mm - int. 64 mm

|          |     |
|----------|-----|
| FINITURA | ANT |
| IMBALLO  | 25  |



**art. 6.5840**

maniglia portanome  
int. 55x23 mm

|          |     |
|----------|-----|
| FINITURA | ANT |
| IMBALLO  | 25  |



**art. 6.5850**

maniglia

|          | 6.5850  | 6.5851  | 6.5852  | 6.5853  |
|----------|---------|---------|---------|---------|
| MISURA   | ø 55 mm | ø 47 mm | ø 37 mm | ø 22 mm |
| FINITURA | ANT     | ANT     | ANT     | ANT     |
| IMBALLO  | 25      | 25      | 25      | 25      |



**art. 6.5860**

maniglia

|          | 6.5860 | 6.5861 |
|----------|--------|--------|
| MISURA   | 96 mm  | 64 mm  |
| FINITURA | ANT    | ANT    |
| IMBALLO  | 25     | 25     |



**art. 6.5870**

maniglia  
86x50 mm - int. 64 mm

|          |     |
|----------|-----|
| FINITURA | ANT |
| IMBALLO  | 25  |



**art. 6.5880**

maniglia

|          | 6.5880                 | 6.5881                |
|----------|------------------------|-----------------------|
| MISURA   | 105x45 mm - int. 64 mm | 76x33 mm - int. 32 mm |
| FINITURA | ANT                    | ANT                   |
| IMBALLO  | 25                     | 25                    |



**art. 6.5890**

maniglia

|          | 6.5890  | 6.5891  | 6.5892  |
|----------|---------|---------|---------|
| MISURA   | ø 70 mm | ø 57 mm | ø 43 mm |
| FINITURA | ANT     | ANT     | ANT     |
| IMBALLO  | 25      | 25      | 25      |



**art. 6.5900**

maniglia

|          | 6.5900                 | 6.5901                |
|----------|------------------------|-----------------------|
| MISURA   | 118x42 mm - int. 96 mm | 82x32 mm - int. 64 mm |
| FINITURA | ANT                    | ANT                   |
| IMBALLO  | 25                     | 25                    |



**art. 6.5910**

maniglia

|          | 6.5910                 | 6.5911                |
|----------|------------------------|-----------------------|
| MISURA   | 118x52 mm - int. 96 mm | 82x40 mm - int. 64 mm |
| FINITURA | ANT                    | ANT                   |
| IMBALLO  | 25                     | 25                    |



**art. 6.5920**

maniglia

|          | 6.5920                 | 6.5921                |
|----------|------------------------|-----------------------|
| MISURA   | 121x47 mm - int. 96 mm | 83x33 mm - int. 64 mm |
| FINITURA | ANT                    | ANT                   |
| IMBALLO  | 25                     | 25                    |



**art. 6.5950**

maniglia  
40x49 mm

|          |     |
|----------|-----|
| FINITURA | ANT |
| IMBALLO  | 25  |



**art. 6.5960**

maniglia  
int. 96 mm

|          |     |
|----------|-----|
| FINITURA | ANT |
| IMBALLO  | 25  |



**art. 6.5970**

maniglia

|          | 6.5970 | 6.5971 |
|----------|--------|--------|
| MISURA   | 96 mm  | 64 mm  |
| FINITURA | ANT    | ANT    |
| IMBALLO  | 25     | 25     |



**art. 6.5980**

maniglia  
int. 96 mm

|          |     |
|----------|-----|
| FINITURA | ANT |
| IMBALLO  | 25  |



**art. 6.5990**

maniglia

|          | 6.5990   | 6.5991   |
|----------|----------|----------|
| MISURA   | 82x43 mm | 64x34 mm |
| FINITURA | ANT      | ANT      |
| IMBALLO  | 25       | 25       |



**art. 6.6000**

maniglia senza foro chiave  
94x44 mm

|          |     |
|----------|-----|
| FINITURA | ANT |
| IMBALLO  | 25  |



**art. 6.6001**

maniglia con foro chiave  
94x44 mm

|          |     |
|----------|-----|
| FINITURA | ANT |
| IMBALLO  | 25  |



**art. 6.6010**

maniglia  
85x34 mm

|          |     |
|----------|-----|
| FINITURA | ANT |
| IMBALLO  | 25  |



**art. 6.6020**

maniglia

6.6020      6.6021      6.6022

|          |           |           |           |
|----------|-----------|-----------|-----------|
| MISURA   | 135x45 mm | 119x39 mm | 105x33 mm |
| FINITURA | ANT       | ANT       | ANT       |
| IMBALLO  | 25        | 25        | 25        |



**art. 6.6030**

maniglia

6.6030      6.6031

|          |           |          |
|----------|-----------|----------|
| MISURA   | 124x52 mm | 84x36 mm |
| FINITURA | ANT       | ANT      |
| IMBALLO  | 25        | 25       |



**art. 6.6040**

maniglia

6.6040      6.6041

|          |         |         |
|----------|---------|---------|
| MISURA   | ø 52 mm | ø 42 mm |
| FINITURA | ANT     | ANT     |
| IMBALLO  | 25      | 25      |



**art. 6.6050**

maniglia

6.6050      6.6051      6.6052

|          |          |          |          |
|----------|----------|----------|----------|
| MISURA   | 96x57 mm | 59x50 mm | 49x40 mm |
| FINITURA | ANT      | ANT      | ANT      |
| IMBALLO  | 25       | 25       | 25       |



**art. 6.6060**

maniglia senza foro chiave  
34x96 mm

|          |     |
|----------|-----|
| FINITURA | ANT |
| IMBALLO  | 25  |



**art. 6.6061**

maniglia con foro chiave  
34x96 mm

|          |     |
|----------|-----|
| FINITURA | ANT |
| IMBALLO  | 25  |



**art. 6.6070**

maniglia  
34X48 mm

|          |     |
|----------|-----|
| FINITURA | ANT |
| IMBALLO  | 25  |



**art. 6.6080**

maniglia  
50X52 mm

|          |     |
|----------|-----|
| FINITURA | ANT |
| IMBALLO  | 25  |



**art. 6.6090**

maniglia  
34X55 mm

|          |     |
|----------|-----|
| FINITURA | ANT |
| IMBALLO  | 25  |



**art. 6.6100**

maniglia

|          | 6.6100   | 6.6101   |
|----------|----------|----------|
| MISURA   | 68X60 mm | 50X48 mm |
| FINITURA | ANT      | ANT      |
| IMBALLO  | 25       | 25       |



**art. 6.6110**

maniglia

|          | 6.6110   | 6.6111   |
|----------|----------|----------|
| MISURA   | 68X60 mm | 50X45 mm |
| FINITURA | ANT      | ANT      |
| IMBALLO  | 25       | 25       |



**art. 6.6120**

maniglia

|          | 6.6120   | 6.6121   |
|----------|----------|----------|
| MISURA   | 60X52 mm | 50X46 mm |
| FINITURA | ANT      | ANT      |
| IMBALLO  | 25       | 25       |



**art. 6.6130**

maniglia

|          | 6.6130  | 6.6131  |
|----------|---------|---------|
| MISURA   | ø 47 mm | ø 37 mm |
| FINITURA | ANT     | ANT     |
| IMBALLO  | 25      | 25      |



**art. 6.6140**

maniglia

|          | 6.6140  | 6.6141  |
|----------|---------|---------|
| MISURA   | ø 51 mm | ø 42 mm |
| FINITURA | ANT     | ANT     |
| IMBALLO  | 25      | 25      |



**art. 6.6190**

bocchetta floreale orizzontale  
115x35 mm

|          |     |
|----------|-----|
| FINITURA | ANT |
| IMBALLO  | 25  |



**art. 6.6195**

bocchetta floreale verticale  
35x115 mm

|          |     |
|----------|-----|
| FINITURA | ANT |
| IMBALLO  | 25  |



**art. 6.6200**

bocchetta  
30x50 mm

|          |     |     |
|----------|-----|-----|
| FINITURA | ANT | OLN |
| IMBALLO  | 25  | 25  |



**art. 6.6205**

bocchetta  
34x46 mm

|          |     |
|----------|-----|
| FINITURA | ANT |
| IMBALLO  | 25  |



**art. 6.6210**

bocchetta  
50x30 mm

|          |     |     |
|----------|-----|-----|
| FINITURA | ANT | OLN |
| IMBALLO  | 25  | 25  |



**art. 6.6220**

bocchetta  
62x34 mm

|          |     |
|----------|-----|
| FINITURA | ANT |
| IMBALLO  | 25  |



**art. 6.6230**

bocchetta  
34x62 mm

|          |     |
|----------|-----|
| FINITURA | ANT |
| IMBALLO  | 25  |



**art. 6.6240**

bocchetta  
15x98 mm

|          |     |
|----------|-----|
| FINITURA | ANT |
| IMBALLO  | 25  |



**art. 6.6250**

bocchetta  
18X36 mm

|          |     |      |
|----------|-----|------|
| FINITURA | ANT | ONLV |
| IMBALLO  | 25  | 25   |



**art. 6.6260**

bocchetta  
24X46 mm

|          |     |
|----------|-----|
| FINITURA | ANT |
| IMBALLO  | 25  |



**art. 6.6270**

bocchetta  
ø 32 mm

|          |     |
|----------|-----|
| FINITURA | ANT |
| IMBALLO  | 25  |



**art. 6.6280**

bocchetta

|          |               |               |
|----------|---------------|---------------|
|          | <b>6.6280</b> | <b>6.6281</b> |
| MISURA   | ø 53 mm       | ø 41 mm       |
| FINITURA | ANT           | ANT           |
| IMBALLO  | 25            | 25            |



**art. 6.6290**

bocchetta  
32x35 mm

|          |     |
|----------|-----|
| FINITURA | ANT |
| IMBALLO  | 25  |



**art. 6.6295**

bocchetta orizzontale  
101x24 mm

|          |     |
|----------|-----|
| FINITURA | ANT |
| IMBALLO  | 25  |



**art. 6.6296**

bocchetta verticale  
24x101 mm

|          |     |
|----------|-----|
| FINITURA | ANT |
| IMBALLO  | 25  |



**art. 6.6300**

bocchetta verticale  
32x96 mm

|          |     |
|----------|-----|
| FINITURA | ANT |
| IMBALLO  | 25  |



**art. 6.6310**

bocchetta orizzontale  
96x32 mm

|          |     |
|----------|-----|
| FINITURA | ANT |
| IMBALLO  | 25  |



**art. 6.6320**

bocchetta  
49x40 mm

|          |     |
|----------|-----|
| FINITURA | ANT |
| IMBALLO  | 25  |



**art. 6.6325**

bocchetta  
s 49 mm

|          |     |
|----------|-----|
| FINITURA | ANT |
| IMBALLO  | 25  |



**art. 6.6330**

bocchetta  
23x43 mm

|          |     |
|----------|-----|
| FINITURA | ANT |
| IMBALLO  | 25  |



**art. 6.6340**

bocchetta  
22x56 mm

|          |     |
|----------|-----|
| FINITURA | ANT |
| IMBALLO  | 25  |



**art. 6.6350**

bocchetta  
36x57 mm

|          |     |
|----------|-----|
| FINITURA | ANT |
| IMBALLO  | 25  |



**art. 6.6360**

bocchetta  
59x62 mm

|          |     |
|----------|-----|
| FINITURA | ANT |
| IMBALLO  | 25  |



**art. 6.6370**

bocchetta  
25x35 mm

|          |     |
|----------|-----|
| FINITURA | ANT |
| IMBALLO  | 25  |



**art. 6.6380**

bocchetta  
35x25 mm

|          |     |
|----------|-----|
| FINITURA | ANT |
| IMBALLO  | 25  |



**art. 6.6385**

bocchetta  
19x52 mm

|          |     |
|----------|-----|
| FINITURA | ANT |
| IMBALLO  | 25  |



**art. 6.6390**

bocchetta  
70x45 mm

|          |     |
|----------|-----|
| FINITURA | ANT |
| IMBALLO  | 25  |



**art. 6.6395**

bocchetta  
96x33 mm

|          |     |
|----------|-----|
| FINITURA | ANT |
| IMBALLO  | 25  |



**art. 3.8610**

pomolino

|          |         |         |         |
|----------|---------|---------|---------|
| MISURA   | ø 22 mm | ø 27 mm | ø 32 mm |
| FINITURA | ANT     | ANT     | ANT     |
| IMBALLO  | 25      | 25      | 25      |



**art. 3.8615**

pomolino

|          |         |         |         |
|----------|---------|---------|---------|
| MISURA   | ø 20 mm | ø 25 mm | ø 30 mm |
| FINITURA | ANT     | ANT     | ANT     |
| IMBALLO  | 25      | 25      | 25      |



**art. 3.8620**

pomolino

|          |         |
|----------|---------|
| MISURA   | ø 30 mm |
| FINITURA | ANT     |
| IMBALLO  | 25      |



**art. 3.8625**

pomolino

|          |         |         |         |
|----------|---------|---------|---------|
| MISURA   | ø 20 mm | ø 25 mm | ø 30 mm |
| FINITURA | ANT     | ANT     | ANT     |
| IMBALLO  | 25      | 25      | 25      |



**art. 3.8630**

pomolino

|          |         |         |         |
|----------|---------|---------|---------|
| MISURA   | ø 24 mm | ø 29 mm | ø 34 mm |
| FINITURA | ANT     | ANT     | ANT     |
| IMBALLO  | 25      | 25      | 25      |



**art. 3.8635**

pomolino

|          |         |         |         |
|----------|---------|---------|---------|
| MISURA   | ø 20 mm | ø 25 mm | ø 30 mm |
| FINITURA | ANT     | ANT     | ANT     |
| IMBALLO  | 25      | 25      | 25      |



**art. 3.8640**

pomolino

|          |         |         |         |
|----------|---------|---------|---------|
| MISURA   | ø 24 mm | ø 29 mm | ø 34 mm |
| FINITURA | ANT     | ANT     | ANT     |
| IMBALLO  | 25      | 25      | 25      |



**art. 3.8645**

pomolino

|          |         |         |         |
|----------|---------|---------|---------|
| MISURA   | ø 20 mm | ø 25 mm | ø 30 mm |
| FINITURA | ANT     | ANT     | ANT     |
| IMBALLO  | 25      | 25      | 25      |



**art. 3.8650**

pomolino

|          |          |
|----------|----------|
| MISURA   | 54x14 mm |
| FINITURA | ANT      |
| IMBALLO  | 25       |



**art. 3.8655**

pomolino

|          |         |         |         |
|----------|---------|---------|---------|
| MISURA   | ø 16 mm | ø 24 mm | ø 27 mm |
| FINITURA | ANT     | ANT     | ANT     |
| IMBALLO  | 25      | 25      | 25      |



**art. 3.8660**

pomolino

|          |          |          |
|----------|----------|----------|
| MISURA   | ø 25 mm  | ø 35 mm  |
| FINITURA | ZAMA ANT | ZAMA ANT |
| IMBALLO  | 25       | 25       |



**art. 3.8665**

pomolino

|          |         |         |
|----------|---------|---------|
| MISURA   | ø 25 mm | ø 30 mm |
| FINITURA | ANT     | ANT     |
| IMBALLO  | 25      | 25      |



**art. 3.8670**

pomolino

|          |          |          |
|----------|----------|----------|
| MISURA   | ø 20 mm  | ø 30 mm  |
| FINITURA | ZAMA ANT | ZAMA ANT |
| IMBALLO  | 25       | 25       |



**art. 3.8675**

pomolino

|          |         |         |
|----------|---------|---------|
| MISURA   | ø 25 mm | ø 35 mm |
| FINITURA | ANT     | ANT     |
| IMBALLO  | 25      | 25      |



**art. 3.8680**

pomolino

|          |         |         |
|----------|---------|---------|
| MISURA   | ø 25 mm | ø 30 mm |
| FINITURA | ANT     | ANT     |
| IMBALLO  | 25      | 25      |



**art. 6.6145**

fregio  
180x45 mm

|          |     |
|----------|-----|
| FINITURA | ANT |
| IMBALLO  | 25  |



**art. 6.6155**

fregio  
155x52 mm

|          |     |
|----------|-----|
| FINITURA | ANT |
| IMBALLO  | 25  |



**art. 6.6165**

fregio  
165x48 mm

|          |     |
|----------|-----|
| FINITURA | ANT |
| IMBALLO  | 25  |



**art. 6.6175**

fregio  
147x49 mm

|          |     |
|----------|-----|
| FINITURA | ANT |
| IMBALLO  | 25  |



**art. 6.6185**

fregio  
96x55 mm

|          |     |
|----------|-----|
| FINITURA | ANT |
| IMBALLO  | 25  |



**art. 6.6186**

fregio  
38x62 mm

|          |     |
|----------|-----|
| FINITURA | ANT |
| IMBALLO  | 25  |



**art. 6.6187**

fregio  
25x108 mm

|          |     |
|----------|-----|
| FINITURA | ANT |
| IMBALLO  | 25  |



**art. 6.6188**

fregio

|          |               |               |
|----------|---------------|---------------|
|          | <b>6.6188</b> | <b>6.6189</b> |
| MISURA   | 18x73 mm      | 23x58 mm      |
| FINITURA | ANT           | ANT           |
| IMBALLO  | 25            | 25            |



**art. 6.6400**

chiave

|          | 6.6400    | 6.6401    |
|----------|-----------|-----------|
| MISURA   | ø 6x40 mm | ø 6x32 mm |
| FINITURA | ANT       | ANT       |
| IMBALLO  | 25        | 25        |



**art. 6.6410**

chiave

|          | 6.6410    |
|----------|-----------|
| MISURA   | ø 6x32 mm |
| FINITURA | ANT       |
| IMBALLO  | 25        |



**art. 6.6420**

chiave

|          | 6.6420      | 6.6420    | 6.6421    | 6.6422       |
|----------|-------------|-----------|-----------|--------------|
| MISURA   | ø 6x40 mm   | ø 6x40 mm | ø 6x32 mm | mappa grande |
| FINITURA | OL NATURALE | ANT       | ANT       | ANT          |
| IMBALLO  | 25          | 25        | 25        | 25           |



**art. 6.6430**

chiave

|          | 6.6430    | 6.6431    |
|----------|-----------|-----------|
| MISURA   | ø 6x43 mm | ø 6x32 mm |
| FINITURA | ANT       | ANT       |
| IMBALLO  | 25        | 25        |



**art. 6.6440**

chiave

|          | 6.6440    | 6.6441    |
|----------|-----------|-----------|
| MISURA   | ø 6x40 mm | ø 6x32 mm |
| FINITURA | ANT       | ANT       |
| IMBALLO  | 25        | 25        |



**art. 6.6460**

chiave

|          | 6.6460    | 6.6461    |
|----------|-----------|-----------|
| MISURA   | ø 6x40 mm | ø 6x32 mm |
| FINITURA | ANT       | ANT       |
| IMBALLO  | 25        | 25        |



**art. 6.6470**

chiave

|          | 6.6470      | 6.6470    | 6.6471    |
|----------|-------------|-----------|-----------|
| MISURA   | ø 6x40 mm   | ø 6x40 mm | ø 6x32 mm |
| FINITURA | OL NATURALE | ANT       | ANT       |
| IMBALLO  | 25          | 25        | 25        |



**art. 2.9060**

rosetta decorativa tonda

|          |         |         |         |         |         |
|----------|---------|---------|---------|---------|---------|
| MISURA   | ø 50 mm | ø 43 mm | ø 35 mm | ø 28 mm | ø 23 mm |
| FINITURA | ANT     | ANT     | ANT     | ANT     | ANT     |
| IMBALLO  | 25      | 25      | 25      | 25      | 25      |



**art. 2.9065**

rosetta decorativa quadra

|          |          |          |
|----------|----------|----------|
| MISURA   | 38x38 mm | 30x30 mm |
| FINITURA | ANT      | ANT      |
| IMBALLO  | 25       | 25       |



**art. 6.5400**

passamano  
ø 30 mm

|          |     |
|----------|-----|
| FINITURA | ANT |
| IMBALLO  | 12  |



**art. 6.6450**

pomolo  
44x36 mm

|          |     |
|----------|-----|
| FINITURA | ANT |
| IMBALLO  | 25  |

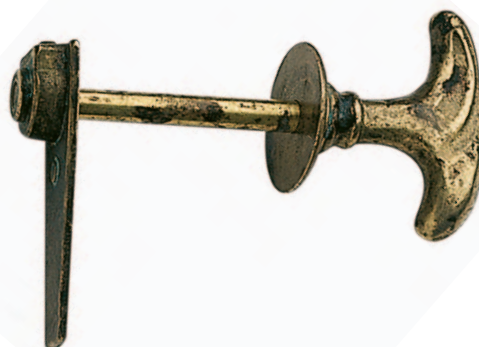

**art. 6.6451**

chiavistello  
44x88 mm

|          |     |
|----------|-----|
| FINITURA | ANT |
| IMBALLO  | 25  |

# serie SET PER TENDE



## art. 6.4060

coppia astina Bris-bris

|          | 6.4060   | 6.4080   | 6.4100    |
|----------|----------|----------|-----------|
| MISURA   | 40/60 mm | 60/80 mm | 80/100 mm |
| FINITURA | OLV      | OLV      | OLV       |
| IMBALLO  | 50       | 100      | 100       |

|          |    |   |   |
|----------|----|---|---|
| FINITURA | CR | - | - |
|----------|----|---|---|

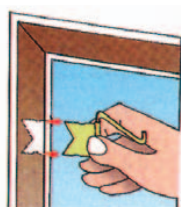

POSIZIONARE

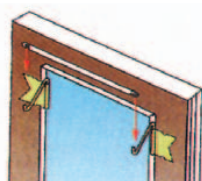

FISSARE



RISULTATO FINALE

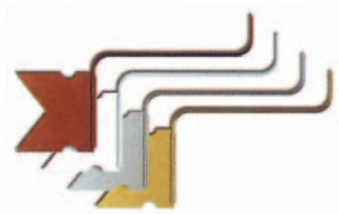

## art. 6.1680

gancetti invisibili per tendine  
si fissano senza colla e senza fori  
su tutti i tipi di finestra e sono riposizionabili  
**disponibili in blister da 4 pezzi**

|          |    |    |     |     |
|----------|----|----|-----|-----|
| FINITURA | BR | BN | NIK | OTT |
| IMBALLO  | 20 | 20 | 20  | 20  |

## art. 6.4450

set completo per tende composto da:

2 finali - 3 mensole - 20 anelli ø 32 mm - 1 bastone telescopico estensibile da 125 mm a max 225 mm

ogni BOX contiene:

8 bastoni con finale art. 6.4350 - 8 bastoni con finale art. 6.4380

|          |              |
|----------|--------------|
| FINITURA | FERRO NR     |
| IMBALLO  | 16 SET x BOX |

# BASTONI PER TENDE

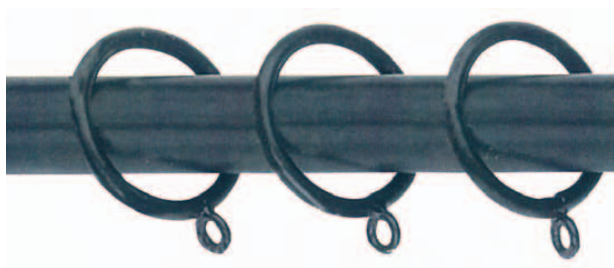

## art. 6.4500

bastone per tende  
ø 19 mm

|          |          |          |          |
|----------|----------|----------|----------|
| MISURA   | 120 mm   | 150 mm   | 180 mm   |
| FINITURA | FERRO NR | FERRO NR | FERRO NR |
| IMBALLO  | 25       | 25       | 25       |



## art. 6.4500.180

bastone per tende  
ø 19 mm

|          |              |
|----------|--------------|
| MISURA   | 180 mm       |
| FINITURA | FERRO NR ORO |
| IMBALLO  | 20           |



## art. 6.4501

adattatore per prolunga bastone nero

# ANELLI PER TENDE



## art. 6.4200

anelli per bastoni reggitende

|          |                  |                  |                  |
|----------|------------------|------------------|------------------|
|          | <b>6.4200.45</b> | <b>6.4200.60</b> | <b>6.4200.72</b> |
| MISURA   | ø est. 45 mm     | ø est. 60 mm     | ø est. 72 mm     |
| FINITURA | OLV              | OLV              | OLV              |
| IMBALLO  | 140              | 140              | 140              |



## art. 6.4250

anelli per bastoni reggitende

|          |                  |                  |
|----------|------------------|------------------|
|          | <b>6.4250.25</b> | <b>6.4250.32</b> |
| MISURA   | ø est. 25 mm     | ø est. 32 mm     |
| FINITURA | FERRO NR         | FERRO NR         |
| IMBALLO  | 50               | 50               |



## art. 6.4250.320

anelli per bastoni reggitende  
ø est. 32 mm

|          |              |
|----------|--------------|
| FINITURA | FERRO NR ORO |
| IMBALLO  | 50           |

smacSerie

# FINALI PER TENDE



**art. 6.4300**

finale per bastone  
ø 19 mm

|          |          |              |
|----------|----------|--------------|
| FINITURA | FERRO NR | FERRO NR ORO |
| IMBALLO  | 6        | 6            |



**art. 6.4310**

finale per bastone  
ø 19 mm

|          |    |
|----------|----|
| FINITURA | NR |
| IMBALLO  | 6  |



**art. 6.4330**

finale per bastone  
ø 19 mm

|          |    |
|----------|----|
| FINITURA | NR |
| IMBALLO  | 6  |



**art. 6.4340**

finale per bastone  
ø 19 mm

|          |    |
|----------|----|
| FINITURA | NR |
| IMBALLO  | 6  |



**art. 6.4350**

finale per bastone  
ø 19 mm

|          |    |        |
|----------|----|--------|
| FINITURA | NR | NR ORO |
| IMBALLO  | 6  | 6      |



**art. 6.4360**

finale per bastone  
ø 19 mm

|          |    |
|----------|----|
| FINITURA | NR |
| IMBALLO  | 6  |



**art. 6.4370**

finale per bastone  
ø 19 mm

|          |    |
|----------|----|
| FINITURA | NR |
| IMBALLO  | 6  |



**art. 6.4380**

finale per bastone  
ø 19 mm

|          |          |              |
|----------|----------|--------------|
| FINITURA | FERRO NR | FERRO NR ORO |
| IMBALLO  | 6        | 6            |

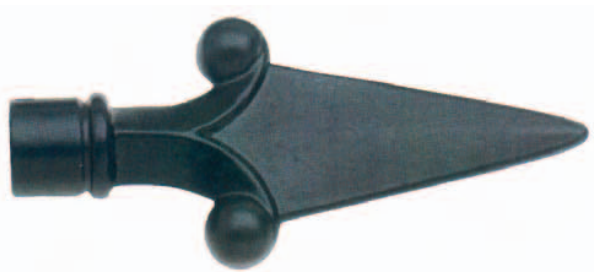

**art. 6.4390**

finale per bastone  
ø 19 mm

|          |    |
|----------|----|
| FINITURA | NR |
| IMBALLO  | 6  |



**art. 7.4700**

finale Ghianda piccola per tenda  
ø 33 mm

|          |     |
|----------|-----|
| FINITURA | OLV |
| IMBALLO  | 12  |



**art. 7.4710**

finale Ghianda grande per tenda  
45x70 mm

|          |     |
|----------|-----|
| FINITURA | OLV |
| IMBALLO  | 6   |



**art. 7.4720**

finale Pigna per tenda  
93x65 mm

|          |     |
|----------|-----|
| FINITURA | OLV |
| IMBALLO  | 2   |



**art. 7.4725**

finale Pigna per tenda  
75x50 mm

|          |     |
|----------|-----|
| FINITURA | OLV |
| IMBALLO  | 2   |



**art. 7.4730**

finale Roma per tenda  
85x80 mm

|          |     |
|----------|-----|
| FINITURA | OLV |
| IMBALLO  | 2   |



**art. 7.4735**

finale Roma per tenda  
78x58 mm

|          |     |
|----------|-----|
| FINITURA | OLV |
| IMBALLO  | 2   |



**art. 7.4740**

finale Girella per tenda  
ø 55 mm

|          |     |
|----------|-----|
| FINITURA | OLV |
| IMBALLO  | 2   |



**art. 7.4745**

finale Margherita per tenda  
ø 50 mm

|          |     |
|----------|-----|
| FINITURA | OLV |
| IMBALLO  | 2   |



**art. 7.4750**

finale Ovale rigata per tenda

|          | 7.4750   | 7.4751   |
|----------|----------|----------|
| MISURA   | 85x45 mm | 95x55 mm |
| FINITURA | OLV      | OLV      |
| IMBALLO  | 2        | 2        |



**art. 7.4760**  
finale a tappo per bastone

|          |         |         |         |
|----------|---------|---------|---------|
| MISURA   | ø 13 mm | ø 20 mm | ø 25 mm |
| FINITURA | OLV     | OLV     | OLV     |
| IMBALLO  | 10      | 10      | 10      |



**art. 7.4765**  
finale a tappo aperto per bastone

|          |         |         |         |
|----------|---------|---------|---------|
| MISURA   | ø 13 mm | ø 20 mm | ø 25 mm |
| FINITURA | OLV     | OLV     | OLV     |
| IMBALLO  | 10      | 10      | 10      |

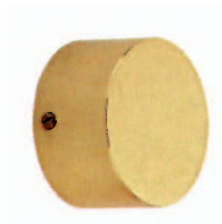

**art. 7.4770**  
finale a tappo chiuso per bastone

|          |         |         |         |         |
|----------|---------|---------|---------|---------|
| MISURA   | ø 20 mm | ø 25 mm | ø 30 mm | ø 35 mm |
| FINITURA | OLV     | OLV     | OLV     | OLV     |
| IMBALLO  | 20      | 20      | 20      | 20      |

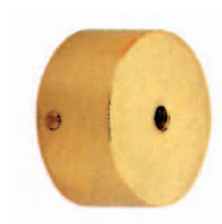

**art. 7.4775**  
finale a tappo passante per bastone

|          |         |         |         |         |
|----------|---------|---------|---------|---------|
| MISURA   | ø 20 mm | ø 25 mm | ø 30 mm | ø 35 mm |
| FINITURA | OLV     | OLV     | OLV     | OLV     |
| IMBALLO  | 20      | 20      | 20      | 20      |



**art. 7.4778**  
finale a cupola per bastone

|          |         |         |         |
|----------|---------|---------|---------|
| MISURA   | ø 13 mm | ø 20 mm | ø 25 mm |
| FINITURA | OLV     | OLV     | OLV     |
| IMBALLO  | 10      | 10      | 10      |

# MENSOLE PER TENDE



## art. 6.1570

mensola estensibile

|          | 6.1570         | 6.1571         |
|----------|----------------|----------------|
| MISURA   | da 80 a 115 mm | da 80 a 160 mm |
| FINITURA | FERRO NR       | FERRO NR       |
| IMBALLO  | 20             | 20             |

|          | 6.1570G      | - |
|----------|--------------|---|
| FINITURA | FERRO NR ORO | - |



## art. 6.1572

mensola doppia

|          |          |
|----------|----------|
| MISURA   | ø 115 mm |
| FINITURA | FERRO NR |
| IMBALLO  | 20       |

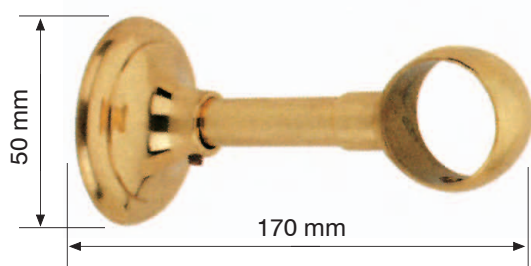

## art. 7.4780

mensola passante

|          |         |         |         |         |
|----------|---------|---------|---------|---------|
| MISURA   | ø 20 mm | ø 25 mm | ø 30 mm | ø 35 mm |
| FINITURA | OLV     | OLV     | OLV     | OLV     |
| IMBALLO  | 6       | 6       | 6       | 6       |

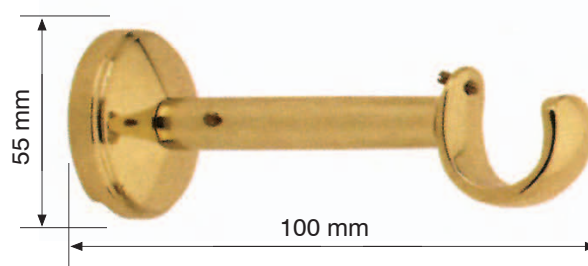

## art. 7.4785

mensola aperta

|          |         |         |         |         |
|----------|---------|---------|---------|---------|
| MISURA   | ø 20 mm | ø 25 mm | ø 30 mm | ø 35 mm |
| FINITURA | OLV     | OLV     | OLV     | OLV     |
| IMBALLO  | 6       | 6       | 6       | 6       |



## art. 7.4790

mensola passante

|          |         |         |         |
|----------|---------|---------|---------|
| MISURA   | ø 13 mm | ø 20 mm | ø 25 mm |
| FINITURA | OLV     | OLV     | OLV     |
| IMBALLO  | 6       | 6       | 6       |



## art. 7.4795

mensola aperta

|          |         |         |         |
|----------|---------|---------|---------|
| MISURA   | ø 13 mm | ø 20 mm | ø 25 mm |
| FINITURA | OLV     | OLV     | OLV     |
| IMBALLO  | 6       | 6       | 6       |

# SUPPORTI PER CORRIMANO



**art. 6.0070**

supporto per corrimano quadro

| FINITURA | OLV | BR | CR | CRS |
|----------|-----|----|----|-----|
| IMBALLO  | 24  | 24 | 24 | 24  |



**art. 6.0071**

supporto per corrimano  
con viti in vista

| FINITURA | OLV | OGR |
|----------|-----|-----|
| IMBALLO  | 24  | 24  |



**art. 6.0073**

supporto per corrimano  
con testa piana e base  $\varnothing$  56 mm

| FINITURA | OLV | OGR | CR | CRS |
|----------|-----|-----|----|-----|
| IMBALLO  | 24  | 24  | 24 | 24  |



**art. 6.0074**

supporto per corrimano  
con testa concava e base  $\varnothing$  56 mm

| FINITURA | OLV | OGR | CR | CRS |
|----------|-----|-----|----|-----|
| IMBALLO  | 24  | 24  | 24 | 24  |

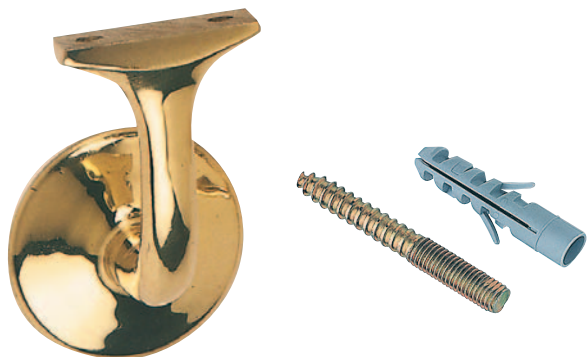

**art. 6.0075**

supporto per corrimano  
con testa piana e base  $\varnothing$  43 mm

| FINITURA | OLV |
|----------|-----|
| IMBALLO  | 24  |



**art. 6.0080**

supporto per corrimano  
con testa piana e base  $\varnothing$  53 mm

| FINITURA | OLV | OGR | CR | CRS |
|----------|-----|-----|----|-----|
| IMBALLO  | 24  | 24  | 24 | 24  |



**art. 6.0081**

supporto per corrimano  
con testa concava e base  $\varnothing$  53 mm

|          |     |     |    |     |
|----------|-----|-----|----|-----|
| FINITURA | OLV | OGR | CR | CRS |
| IMBALLO  | 24  | 24  | 24 | 24  |

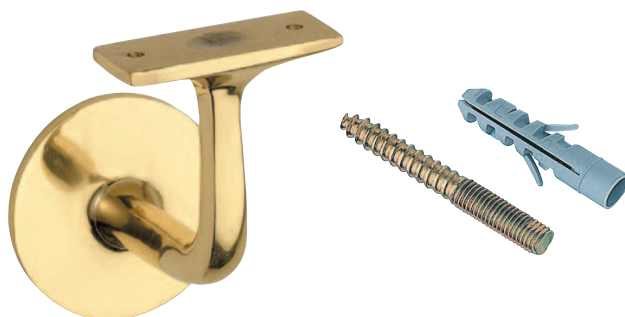

**art. 6.0085**

supporto per corrimano  
con testa piana Slim

|          |     |     |    |     |
|----------|-----|-----|----|-----|
| FINITURA | OLV | OGR | CR | CRS |
| IMBALLO  | 24  | 24  |    |     |



**art. 6.0088**

supporto per corrimano passante dritto  
per tubo  $\varnothing$  35 mm - sporgenza 106 mm  
e base  $\varnothing$  56 mm

|          |     |     |    |     |
|----------|-----|-----|----|-----|
| FINITURA | OLV | OGR | CR | CRS |
| IMBALLO  | 6   | 6   | 6  | 6   |



**art. 6.0089**

supporto per corrimano passante curvo  
per tubo  $\varnothing$  35 mm - sporgenza 115 mm  
e base  $\varnothing$  56 mm

|          |     |     |    |     |
|----------|-----|-----|----|-----|
| FINITURA | OLV | OGR | CR | CRS |
| IMBALLO  | 6   | 6   | 6  | 6   |



**art. 6.3150**

finale per corda

|          |                     |                     |                     |
|----------|---------------------|---------------------|---------------------|
| MISURA   | $\varnothing$ 20 mm | $\varnothing$ 30 mm | $\varnothing$ 35 mm |
| FINITURA | OLV                 | OLV                 | OLV                 |
| IMBALLO  | 24                  | 24                  | 24                  |



serie **REGGIMENSOLE**  
REGGIMENSOLE



**art. 6.1440**

reggimensola artistica  
125x172x22

|          |     |
|----------|-----|
| FINITURA | OLV |
| IMBALLO  | 12  |



**art. 6.1450**

reggimensola a morsetto  
25x25 mm - base int. 8 mm

|          |    |     |
|----------|----|-----|
| FINITURA | OL | NIK |
| IMBALLO  | 30 | 30  |



**art. 6.1451**

reggimensola a morsetto  
25x30 mm - base int. 8 mm

|          |    |     |
|----------|----|-----|
| FINITURA | OL | NIK |
| IMBALLO  | 30 | 30  |

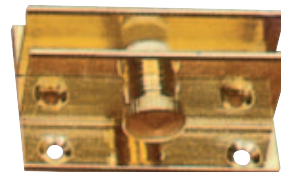

**art. 6.1452**

reggimensola a morsetto  
25x40 mm - base int. 8 mm

|          |    |     |
|----------|----|-----|
| FINITURA | OL | NIK |
| IMBALLO  | 30 | 30  |



**art. 6.1455**

reggimensola a morsetto  
25x20 mm - spessore max 10 mm

|          |    |     |
|----------|----|-----|
| FINITURA | OL | NIK |
| IMBALLO  | 30 | 30  |



**art. 6.1456**

reggimensola a morsetto  
25x25 mm - spessore max 10 mm

|          |    |     |
|----------|----|-----|
| FINITURA | OL | NIK |
| IMBALLO  | 30 | 30  |



**art. 6.1457**

reggimensola a morsetto  
25x30 mm - spessore max 10 mm

|          |    |     |
|----------|----|-----|
| FINITURA | OL | NIK |
| IMBALLO  | 30 | 30  |



**art. 6.1458**

reggimensola a morsetto  
25x35 mm - spessore max 10 mm

|          |    |     |
|----------|----|-----|
| FINITURA | OL | NIK |
| IMBALLO  | 30 | 30  |



**art. 6.1459**

reggimensola a morsetto  
25x40 mm - spessore max 10 mm

|          |    |     |
|----------|----|-----|
| FINITURA | OL | NIK |
| IMBALLO  | 30 | 30  |

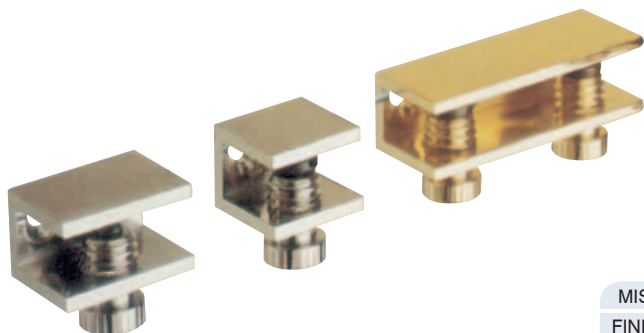

**art. 6.1460**

reggimensola a morsetto normale spessore max 10 mm

|          | 6.1460   | 6.1461   | 6.1462   | 6.1463   | 6.1464   |
|----------|----------|----------|----------|----------|----------|
| MISURA   | 15x15 mm | 15x20 mm | 15x25 mm | 15x30 mm | 15x35 mm |
| FINITURA | OL       | OL       | OL       | OL       | OL       |
| IMBALLO  | 30       | 30       | 30       | 30       | 30       |

|          |     |     |     |     |     |
|----------|-----|-----|-----|-----|-----|
| FINITURA | NIK | NIK | NIK | NIK | NIK |
|----------|-----|-----|-----|-----|-----|



**art. 6.1420**

reggimensola per vetro fresata  
 ø 23 mm - spessore max 10 mm

| FINITURA | OLV | CROM | CRS |
|----------|-----|------|-----|
| IMBALLO  | 25  | 25   | 25  |



**art. 6.1430**

reggimensola per specchio  
 ø 25 mm

| FINITURA | OLV | CROM | CRS |
|----------|-----|------|-----|
| IMBALLO  | 25  | 25   | 25  |



**art. 6.1435**

reggimensola per vetrine  
 ø 20 mm - spessore max 8 mm

| FINITURA | OLV | CR | CRS |
|----------|-----|----|-----|
| IMBALLO  | 25  | 25 | 25  |



**art. 6.1465**

reggimensola  
 38X18 mm - int. 12 mm

| FINITURA | OLV | CR | CRS |
|----------|-----|----|-----|
| IMBALLO  | 20  | 20 | 20  |



**art. 6.1466**

reggimensola  
 38x18 mm - int. 8 mm

| FINITURA | OLV | CR | CRS |
|----------|-----|----|-----|
| IMBALLO  | 20  | 20 | 20  |



**art. 6.1470**

reggimensola per vetro

|            | 6.1470   | 6.1471   | 6.1472   |
|------------|----------|----------|----------|
| MISURA     | 20x25 mm | 25x25 mm | 25x30 mm |
| SPESS. MAX | 8 mm     | 11 mm    | 14 mm    |
| FINITURA   | OLV      | OLV      | OLV      |
| IMBALLO    | 24       | 24       | 24       |

| FINITURA | NIK | NIK | NIK |
|----------|-----|-----|-----|
|----------|-----|-----|-----|

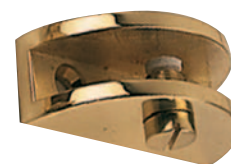

**art. 6.1480**

reggimensola per vetro  
 50x30 mm - spessore max 10 mm

| FINITURA | OLV | CR | CRS |
|----------|-----|----|-----|
| IMBALLO  | 12  | 12 | 12  |



**art. 6.1490**

reggimensola per vetro  
 70x30 mm - spessore max 10 mm

| FINITURA | OLV | CR | CRS |
|----------|-----|----|-----|
| IMBALLO  | 12  | 12 | 12  |



**art. 6.1510**

reggimensola per vetro  
 25x20 mm - int. 12 mm

| FINITURA | OLV | CR | CRS |
|----------|-----|----|-----|
| IMBALLO  | 24  | 24 | 24  |



**art. 6.1515**

reggimensola ad angolo  
 int. 12 mm

| FINITURA | OLV | CR | CRS |
|----------|-----|----|-----|
| IMBALLO  | 12  | 12 | 12  |



### art. 6.1520

reggimensola

|          | 6.1520.10 | 6.1520.15 | 6.1520.20 |
|----------|-----------|-----------|-----------|
| MISURA   | 100 mm    | 150 mm    | 200 mm    |
| FINITURA | OL        | OL        | OL        |
| IMBALLO  | 12        | 12        | 12        |
| FINITURA | NIK       | NIK       | NIK       |

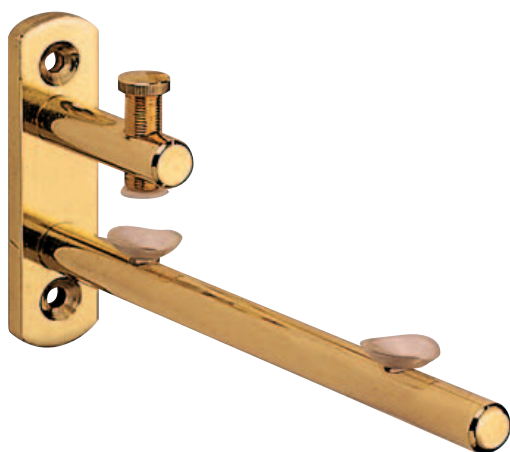

### art. 6.1530

reggimensola

|          | 6.1530.10 | 6.1530.15 | 6.1530.20 |
|----------|-----------|-----------|-----------|
| MISURA   | 100 mm    | 150 mm    | 200 mm    |
| FINITURA | OL        | OL        | OL        |
| IMBALLO  | 12        | 12        | 12        |
| FINITURA | NIK       | NIK       | NIK       |

### art. 6.1540

reggimensola con sostegno di rinforzo

|          | 6.1540.10 | 6.1540.15 | 6.1540.20 |
|----------|-----------|-----------|-----------|
| MISURA   | 100 mm    | 150 mm    | 200 mm    |
| FINITURA | OL        | OL        | OL        |
| IMBALLO  | 12        | 12        | 12        |
| FINITURA | NIK       | NIK       | NIK       |

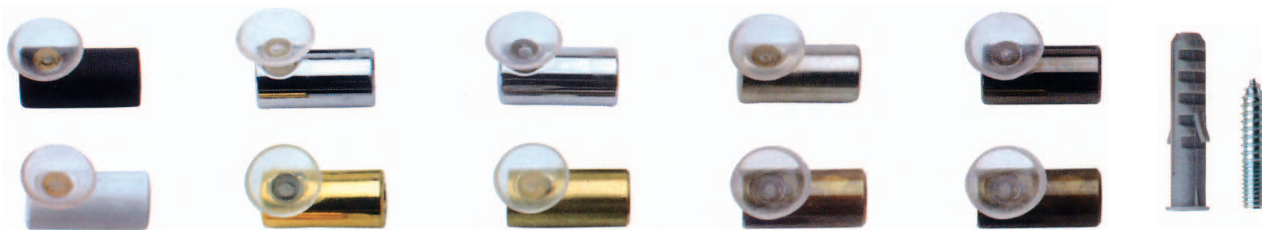

### art. 6.1560

reggimensola Smart con foro 4 ma, vite e tassello

| FINITURA | NR | CR | CRS | NIK MAT | BN | OLV | SAT | BR | ANT |
|----------|----|----|-----|---------|----|-----|-----|----|-----|
| IMBALLO  | 25 | 25 | 25  | 25      | 25 | 25  | 25  | 25 | 25  |

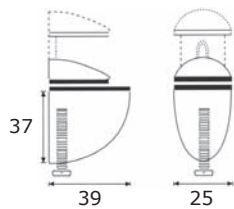

**art. 6.1582**

reggimensola Tuc piccolo  
37x39x25 mm - spessore max 14 mm

| FINITURA | CR | CRS | NIK |
|----------|----|-----|-----|
| IMBALLO  | 10 | 10  | 10  |

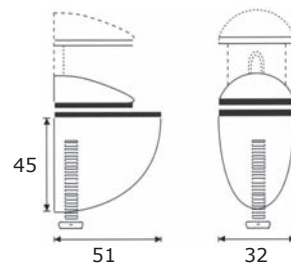

**art. 6.1583**

reggimensola Tuc grande  
45x51x32 mm - spessore max 22 mm

| FINITURA | CR | CRS | NIK |
|----------|----|-----|-----|
| IMBALLO  | 10 | 10  | 10  |

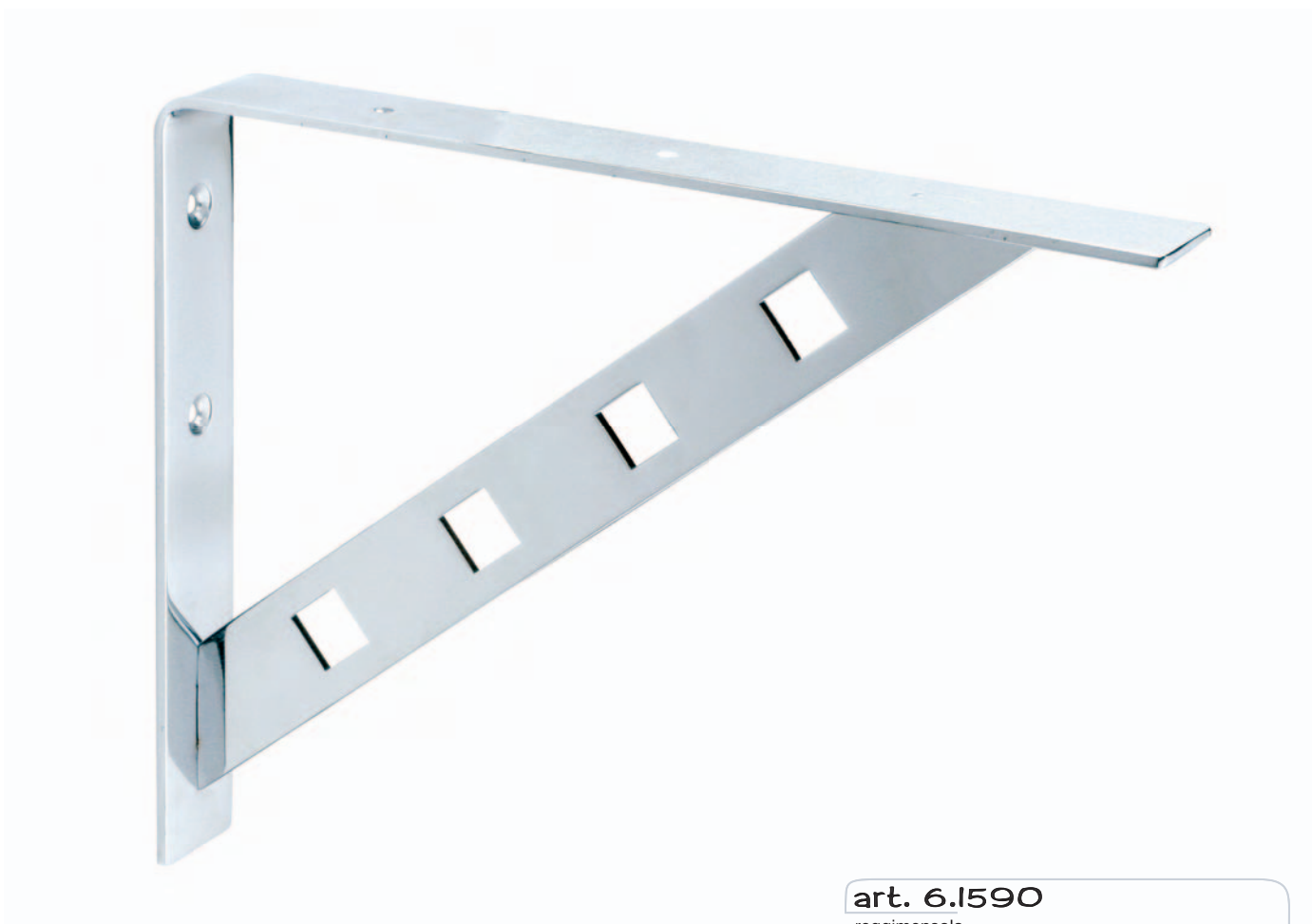

**art. 6.1590**

reggimensola

|          |            |            |
|----------|------------|------------|
| MISURA   | 190x140 mm | 240x190 mm |
| FINITURA | ACC. CR    | ACC. CR    |
| IMBALLO  | 6          | 6          |

# Accessori Vari

## PINZE

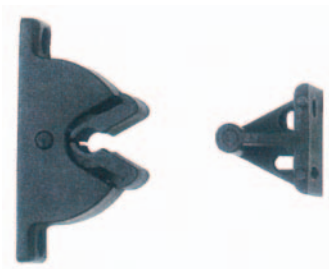

### art. 5.5340

pinza con incontro ad avvitare  
completa di viti e tassello

|          |          |
|----------|----------|
| FINITURA | NYLON NR |
| IMBALLO  | 50       |

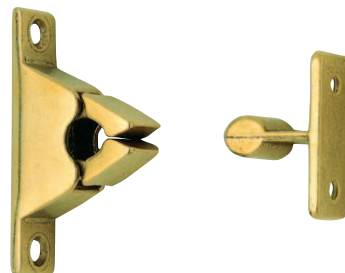

### art. 6.0001

pinza fermaporta  
con incontro ad avvitare

|          |    |    |
|----------|----|----|
| FINITURA | OL | BR |
| IMBALLO  | 50 | 50 |

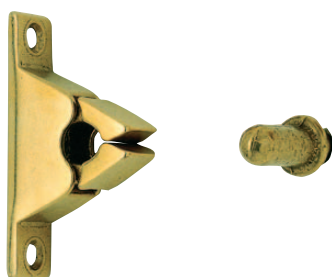

### art. 6.0002

pinza fermaporta  
con incontro a piombare

|          |    |    |
|----------|----|----|
| FINITURA | OL | BR |
| IMBALLO  | 50 | 50 |



### art. 6.0005

incontro per pinza fermaporta  
ad avvitare

|          |    |    |
|----------|----|----|
| FINITURA | OL | BR |
| IMBALLO  | 50 | 50 |



### art. 6.0006

incontro per pinza fermaporta  
a piombare

|          |    |    |
|----------|----|----|
| FINITURA | OL | BR |
| IMBALLO  | 50 | 50 |



### art. 6.0300

pinza ottone trafilato  
inc. piolo

|          |     |
|----------|-----|
| FINITURA | OLV |
| IMBALLO  | 50  |

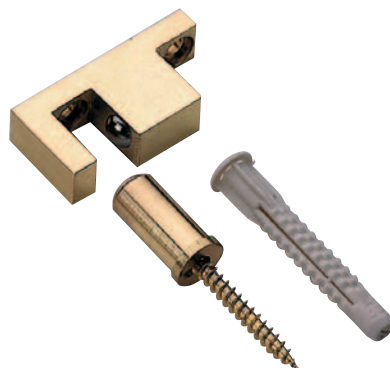

### art. 6.0310

pinza ottone trafilato  
inc. tassello

|          |     |
|----------|-----|
| FINITURA | OLV |
| IMBALLO  | 50  |



### art. 6.0320

pinza ottone trafilato  
inc. parete

|          |     |
|----------|-----|
| FINITURA | OLV |
| IMBALLO  | 50  |



**art. 6.3300**

chiodo a piramide per portone  
20x20 mm

|          |    |    |
|----------|----|----|
| FINITURA | OL | BR |
| IMBALLO  | 24 | 24 |



**art. 6.3305**

chiodo a piramide con vite separata

|          |          |          |          |
|----------|----------|----------|----------|
| MISURA   | 20x20 mm | 25x25 mm | 30x30 mm |
| FINITURA | OL       | OL       | OL       |
| IMBALLO  | 50       | 50       | 50       |

|          |     |     |     |
|----------|-----|-----|-----|
| FINITURA | ANT | ANT | ANT |
|----------|-----|-----|-----|



**art. 6.0050**

borchia copridado ottagonale  
ø 30 mm

|          |     |     |     |
|----------|-----|-----|-----|
| FINITURA | OLV | OGR | CRS |
| IMBALLO  | 24  | 24  | 24  |



**art. 6.0051**

borchia copridado tonda  
ø 30 mm

|          |     |     |     |
|----------|-----|-----|-----|
| FINITURA | OLV | OGR | CRS |
| IMBALLO  | 24  | 24  | 24  |



**art. 6.0052**

borchia coprifiletto esagonale  
ø 22 mm - h. 12 mm

|          |     |     |     |
|----------|-----|-----|-----|
| FINITURA | OLV | ANT | CRS |
| IMBALLO  | 25  | 25  | 25  |



**art. 6.0058**

borchia copridado  
ø 30 mm

|          |     |    |
|----------|-----|----|
| FINITURA | OLV | BR |
| IMBALLO  | 50  | 50 |



**art. 6.0021**

cricchetto per sopra luce  
con incontro ad angolo

|          |    |
|----------|----|
| FINITURA | OL |
| IMBALLO  | 50 |

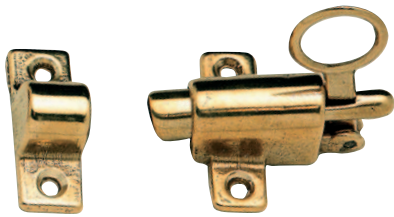

**art. 6.0022**

cricchetto per sopra luce  
con incontro ad angolo piano

|          |    |
|----------|----|
| FINITURA | OL |
| IMBALLO  | 50 |

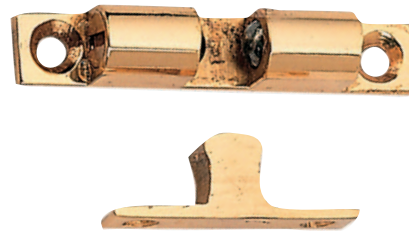

**art. 6.0027**

cricchetto a sfera

|          |                  |                  |                  |                  |
|----------|------------------|------------------|------------------|------------------|
|          | <b>6.0027.42</b> | <b>6.0027.50</b> | <b>6.0027.60</b> | <b>6.0027.70</b> |
| MISURA   | 42 mm            | 50 mm            | 60 mm            | 70 mm            |
| FINITURA | OLV              | OLV              | OLV              | OLV              |
| IMBALLO  | 24               | 24               | 24               | 24               |

**NODO e TERMINALE**  
NODO e TERMINALE



**art. 6.3120**

nodo liscio

|          |                   |                   |
|----------|-------------------|-------------------|
|          | <b>6.3120.12</b>  | <b>6.3120.14</b>  |
| MISURA   | ø 30 - foro 12 mm | ø 30 - foro 14 mm |
| FINITURA | OLV               | OLV               |
| IMBALLO  | 12                | 12                |

|          |                   |                   |
|----------|-------------------|-------------------|
|          | <b>6.3120.16</b>  | <b>6.3120.18</b>  |
| MISURA   | ø 30 - foro 16 mm | ø 30 - foro 18 mm |
| FINITURA | OLV               | OLV               |
| IMBALLO  | 12                | 12                |



**art. 6.3125**

terminale

|          |                   |                   |
|----------|-------------------|-------------------|
|          | <b>6.3125.12</b>  | <b>6.3125.14</b>  |
| MISURA   | ø 30 - foro 12 mm | ø 30 - foro 14 mm |
| FINITURA | OLV               | OLV               |
| IMBALLO  | 24                | 24                |

|          |                   |                   |
|----------|-------------------|-------------------|
|          | <b>6.3125.16</b>  | <b>6.3125.18</b>  |
| MISURA   | ø 30 - foro 16 mm | ø 30 - foro 18 mm |
| FINITURA | OLV               | OLV               |
| IMBALLO  | 24                | 24                |



**art. 6.0095**

tavellino rettangolare a scatto  
50x70 mm - con incontro 16 mm

|          |     |     |
|----------|-----|-----|
| FINITURA | OLV | OGR |
| IMBALLO  | 20  | 20  |

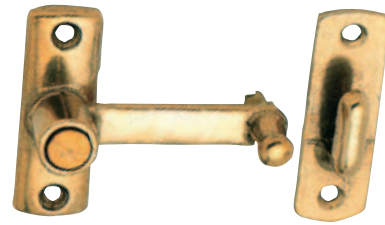

**art. 6.0100**

tavellino a scatto con incontro

|          | 6.0100.05 | 6.0100.10 | 6.0100.15 | 6.0100.20 | 6.0100.25 | 6.0100.30 |
|----------|-----------|-----------|-----------|-----------|-----------|-----------|
| MISURA   | 5 mm      | 10 mm     | 15 mm     | 20 mm     | 25 mm     | 30 mm     |
| FINITURA | OL        | OL        | OL        | OL        | OL        | OL        |
| IMBALLO  | 50        | 50        | 50        | 50        | 50        | 50        |
| FINITURA | BR        | BR        | BR        | BR        | BR        | BR        |



**art. 6.0101**

tavellino regolabile

|          |     |
|----------|-----|
| FINITURA | OLV |
| IMBALLO  | 25  |



**art. 6.0105**

tavellino gigante 80 mm su rosetta  
con incontro 5 - 25 - 30 mm

|          |     |     |
|----------|-----|-----|
| FINITURA | OLV | OGR |
| IMBALLO  | 20  | 20  |

FINALE e PASSANTE  
FINALE e PASSANTE

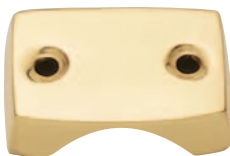

**art. 6.0033**

passante per aste esterne

|          |     |     |    |     |
|----------|-----|-----|----|-----|
| FINITURA | OLV | OGR | CR | CRS |
| IMBALLO  | 25  | 25  | 25 | 25  |



**art. 6.0035**

finale per aste esterne

|          |     |     |    |     |
|----------|-----|-----|----|-----|
| FINITURA | OLV | OGR | CR | CRS |
| IMBALLO  | 25  | 25  | 25 | 25  |

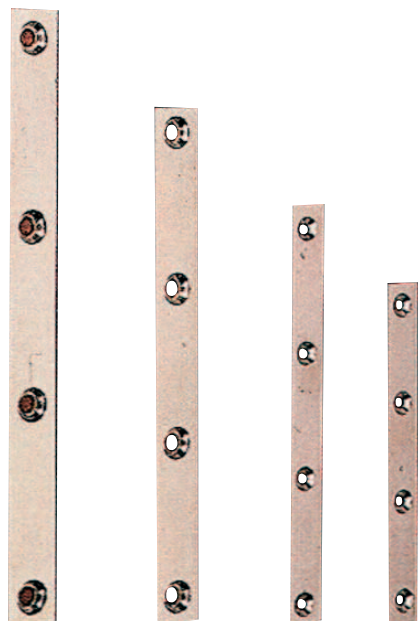

**art. 6.2010**

aste piane svasate

|          |       |       |        |        |
|----------|-------|-------|--------|--------|
| MISURA   | 60 mm | 80 mm | 100 mm | 120 mm |
| FINITURA | OL    | OL    | OL     | OL     |
| IMBALLO  | 50    | 50    | 50     | 50     |

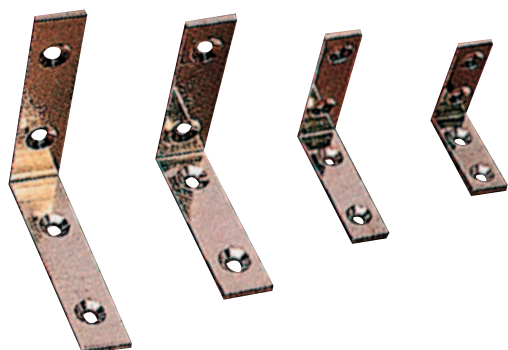

**art. 6.2000**

angolare reggipiano

|          |          |          |          |          |
|----------|----------|----------|----------|----------|
| MISURA   | 30x30 mm | 40x40 mm | 50x50 mm | 60x60 mm |
| FINITURA | OL       | OL       | OL       | OL       |
| IMBALLO  | 50       | 50       | 50       | 50       |

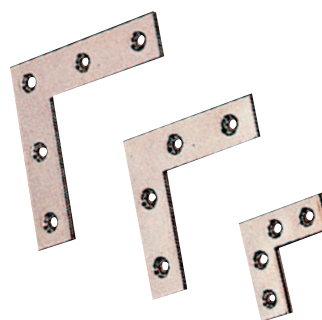

**art. 6.2015**

angolare piano

|          |          |          |          |
|----------|----------|----------|----------|
| MISURA   | 30x30 mm | 45x45 mm | 60x60 mm |
| FINITURA | OL       | OL       | OL       |
| IMBALLO  | 50       | 50       | 50       |



**art. 6.1445**

angolare liscio  
51x51 mm - h. 17 mm

|          |     |
|----------|-----|
| FINITURA | OLV |
| IMBALLO  | 12  |



**art. 6.1446**

angolare decorato  
63x63 mm - h. 23 mm

|          |     |
|----------|-----|
| FINITURA | OLV |
| IMBALLO  | 12  |

## CAVALLOTTO

CAVALLOTTO



### art. 6.0110

cavalotto a rullo

|          | 6.0110.10 | 6.0110.15 | 6.0110.18 |
|----------|-----------|-----------|-----------|
| MISURA   | 10 mm     | 15 mm     | 18 mm     |
| FINITURA | OL        | OL        | OL        |
| IMBALLO  | 100       | 100       | 100       |

|          | 6.0110.20 | 6.0110.22 | 6.0110.25 | 6.0110.30 |
|----------|-----------|-----------|-----------|-----------|
| MISURA   | 20 mm     | 22 mm     | 25 mm     | 30 mm     |
| FINITURA | OL        | OL        | OL        | OL        |
| IMBALLO  | 100       | 100       | 100       | 100       |

## GUIDA LUCERNARI

GUIDA LUCERNARI



01



02



03

### art. 6.0030

guida per lucernari con incontro

|          | 6.0030.01 | 6.0030.02 | 6.0030.03 |
|----------|-----------|-----------|-----------|
| FINITURA | OL        | OL        | OL        |
| IMBALLO  | 25        | 25        | 25        |

## MANIGLIA BLOCCO

MANIGLIA BLOCCO



### art. 6.0120

maniglia Blocco

|          | 6.0120 DX | 6.0121 SX |
|----------|-----------|-----------|
| FINITURA | OL        | OL        |
| IMBALLO  | 12        | 12        |

|          |    |    |
|----------|----|----|
| FINITURA | BR | BR |
|----------|----|----|



**art. 6.0060**

pozzuolo con molla

|          | 6.0060.06 | 6.0060.08 | 6.0060.10 | 6.0060.12 |
|----------|-----------|-----------|-----------|-----------|
| MISURA   | ø 6 mm    | ø 8 mm    | ø 10 mm   | ø 12 mm   |
| FINITURA | OL        | OL        | OL        | OL        |
| IMBALLO  | 50        | 50        | 50        | 50        |

|          | 6.0060.14 | 6.0060.16 | 6.0060.18 | 6.0060.20 | 6.0060.22 |
|----------|-----------|-----------|-----------|-----------|-----------|
| MISURA   | ø 14 mm   | ø 16 mm   | ø 18 mm   | ø 20 mm   | ø 22 mm   |
| FINITURA | OL        | OL        | OL        | OL        | OL        |
| IMBALLO  | 50        | 50        | 50        | 50        | 50        |

DISTANZIALI  
DISTANZIALI



**art. 7.0310**

distanziale per targhe  
ø 14 mm

| FINITURA | OLV | SAT | OGR | CR | CRS |
|----------|-----|-----|-----|----|-----|
| IMBALLO  | 25  | 25  | 25  | 25 | 25  |

TIRADOR  
TIRADOR



**art. 9.0103**

tirador per scorrevole tipo Eko

| FINITURA | OLV | OGR |
|----------|-----|-----|
| IMBALLO  | 12  | 12  |



**art. 9.0105**

tirador per scorrevole tipo Sfera

| FINITURA | OLV | OGR |
|----------|-----|-----|
| IMBALLO  | 12  | 12  |

SPIONCINO  
SPIONCINO



**art. 9.0531.02**

spioncino ø 14 mm  
da 50 a 80 mm

| FINITURA | OLV | CR | CRS |
|----------|-----|----|-----|
| IMBALLO  | 12  | 12 | 12  |



**art. 9.0531.03**

spioncino ø 14 mm  
da 70 a 110 mm

| FINITURA | OLV | CR | CRS |
|----------|-----|----|-----|
| IMBALLO  | 12  | 12 | 12  |

## DK DI SICUREZZA

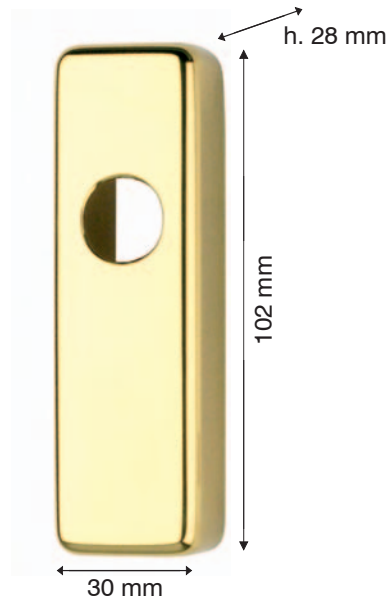
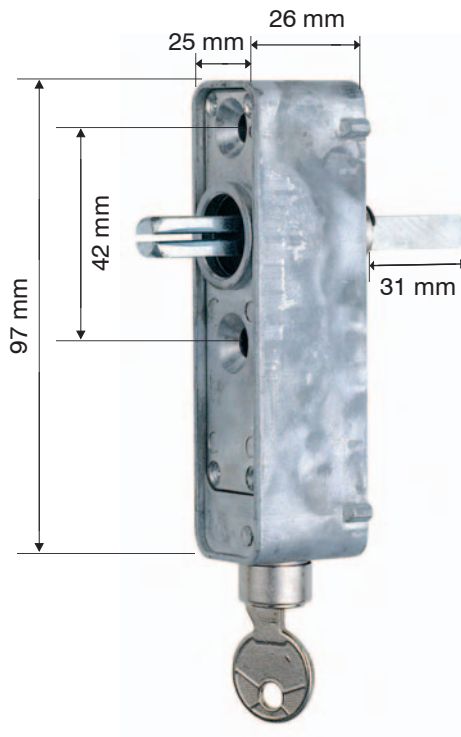

### art. 9.0067

dk di sicurezza con serratura  
utilizzabile con tutti i tipi di maniglie

| FINITURA | OLV | OGR | SAT | CR | CRS |
|----------|-----|-----|-----|----|-----|
| IMBALLO  | 2   | 2   | 2   | 2  | 2   |

AL PREZZO INDICATO VA AGGIUNTO  
IL COSTO DELL'IMPUGNATURA SCELTA

## PROTEZIONE CILINDRO



### art. 5.4320

protezione corazzata per cilindro

| FINITURA | OLV | OGR | CRS | PVD |
|----------|-----|-----|-----|-----|
| IMBALLO  | 1   | 1   | 1   | 1   |

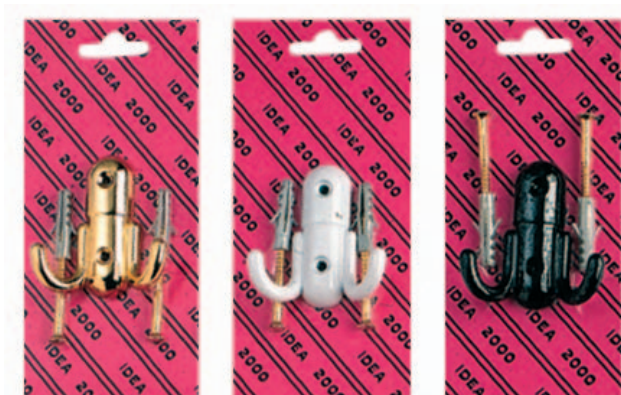

DISPONIBILI FINO AD ESAURIMENTO SCORTE

**art. 3.2300**

skin portabito gigante  
misura A 60x27x57 mm - 1 pezzo

FINITURA Z. BN

IMBALLO 20

FINITURA Z. ORO

FINITURA Z. NR

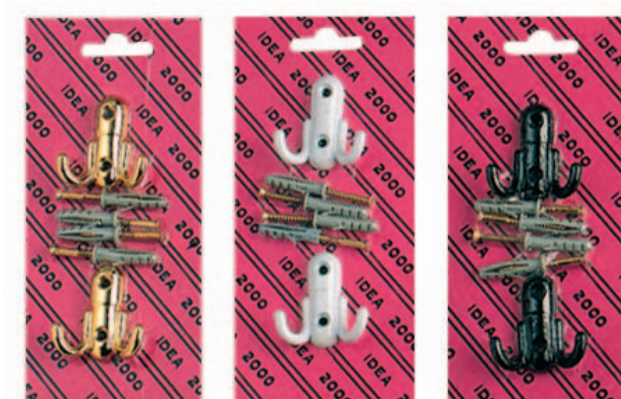

DISPONIBILI FINO AD ESAURIMENTO SCORTE

**art. 3.2310**

skin portabito gigante  
misura B 40x28x38 mm - 2 pezzi

FINITURA Z. BN

IMBALLO 20

FINITURA Z. ORO

FINITURA Z. NR

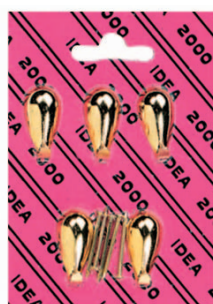

**art. 5.590I**

skin gancio a goccia  
29x15x11 mm - 5 pezzi

FINITURA Z. BN

IMBALLO 50

FINITURA Z. ORO

FINITURA Z. NR



**art. 5.5910**

skin gancio a goccia forata  
5 pezzi

FINITURA Z. ORO

IMBALLO 50



**art. 5.5920**

skin gancio bottoncino forato  
5 pezzi

|          |        |
|----------|--------|
| FINITURA | Z. ORO |
| IMBALLO  | 50     |

DISPONIBILI FINO AD  
ESAURIMENTO SCORTE



**art. 5.5930**

skin gancio quadrifoglio grande  
4 pezzi

|          |    |
|----------|----|
| FINITURA | OL |
| IMBALLO  | 25 |

DISPONIBILI FINO AD  
ESAURIMENTO SCORTE

**art. 5.5935**

skin gancio quadrifoglio piccolo  
4 pezzi

|          |    |
|----------|----|
| FINITURA | OL |
| IMBALLO  | 25 |



**art. 5.5940**

skin gancio tulipano grande  
4 pezzi

|          |    |
|----------|----|
| FINITURA | OL |
| IMBALLO  | 25 |

DISPONIBILI FINO AD  
ESAURIMENTO SCORTE



**art. 5.5950**

skin gancio giglio piccolo  
5 pezzi

|          |        |       |
|----------|--------|-------|
| FINITURA | Z. OTT | Z. BR |
| IMBALLO  | 25     | 25    |

**art. 5.5945**

skin gancio tulipano piccolo  
4 pezzi

|          |    |
|----------|----|
| FINITURA | OL |
| IMBALLO  | 25 |

**art. 5.5955**

skin gancio giglio medio  
5 pezzi

|          |        |       |
|----------|--------|-------|
| FINITURA | Z. OTT | Z. BR |
| IMBALLO  | 25     | 25    |



**art. 5.5960**

skin gancio triangolo  
4 pezzi

|          |    |
|----------|----|
| FINITURA | OL |
| IMBALLO  | 25 |

DISPONIBILI FINO AD  
ESAURIMENTO SCORTE



**art. 5.5970**

skin gancio margherita  
4 pezzi

|          |    |
|----------|----|
| FINITURA | OL |
| IMBALLO  | 25 |

DISPONIBILI FINO AD  
ESAURIMENTO SCORTE



**art. 5.5980**

skin gancio Luna  
5 pezzi

|          |    |
|----------|----|
| FINITURA | OL |
| IMBALLO  | 25 |

DISPONIBILI FINO AD  
ESAURIMENTO SCORTE

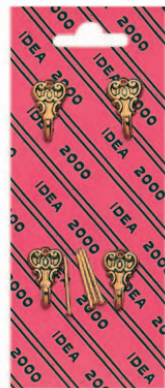

**art. 5.5990**

skin gancio Barocco  
4 pezzi

|          |    |
|----------|----|
| FINITURA | OL |
| IMBALLO  | 25 |

DISPONIBILI FINO AD  
ESAURIMENTO SCORTE

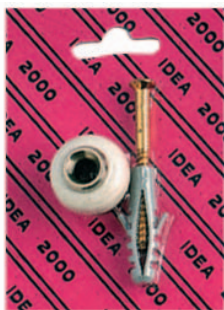

**art. 6.0048**

skin fermaporta  
ø 20 mm - 1 pezzi

|          |        |        |
|----------|--------|--------|
| FINITURA | OTT/NR | OTT/BN |
| IMBALLO  | 20     | 20     |

DISPONIBILI FINO AD  
ESAURIMENTO SCORTE



**art. 6.1300**

skin appendiquadri tondino ø 6 mm  
con applicatore 4 pezzi

|          |        |
|----------|--------|
| FINITURA | Z. ORO |
| IMBALLO  | 50     |

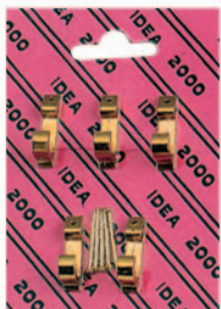

**art. 6.1310**

skin appendiquadri in ottone  
5 pezzi

|          |    |    |
|----------|----|----|
| FINITURA | OL | BR |
| IMBALLO  | 50 | 50 |

DISPONIBILI FINO AD  
ESAURIMENTO SCORTE



**art. 6.1320**

skin gancio snodato  
2 pezzi

|          |       |        |
|----------|-------|--------|
| FINITURA | Z. BR | Z. ORO |
| IMBALLO  | 50    | 50     |



**art. 6.1500**

skin mensola reggispecchio  
a morsetto 25x40 mm - 2 pezzi

|          |    |
|----------|----|
| FINITURA | OL |
| IMBALLO  | 2  |

DISPONIBILI FINO AD  
ESAURIMENTO SCORTE



**art. 6.1600**

skin gancio fiocco  
5 pezzi

|          |          |
|----------|----------|
| FINITURA | ACC. ORO |
| IMBALLO  | 25       |

DISPONIBILI FINO AD  
ESAURIMENTO SCORTE



**art. 6.1610**

skin gancio foglie  
5 pezzi

|          |          |
|----------|----------|
| FINITURA | ACC. ORO |
| IMBALLO  | 25       |

DISPONIBILI FINO AD  
ESAURIMENTO SCORTE

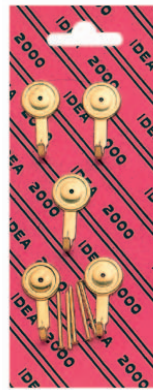

**art. 6.1620**

skin gancio tondo  
16x34 mm - 5 pezzi

|          |          |
|----------|----------|
| FINITURA | ACC. ORO |
| IMBALLO  | 25       |

DISPONIBILI FINO AD  
ESAURIMENTO SCORTE

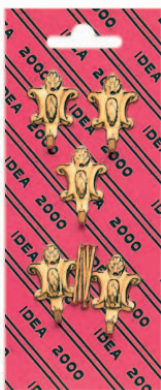

**art. 6.1630**

skin gancio stamma  
5 pezzi

|          |          |
|----------|----------|
| FINITURA | ACC. ORO |
| IMBALLO  | 25       |

DISPONIBILI FINO AD  
ESAURIMENTO SCORTE



**art. 6.1640**

skin gancio nastrino  
5 pezzi

|          |          |
|----------|----------|
| FINITURA | ACC. ORO |
| IMBALLO  | 25       |

DISPONIBILI FINO AD  
ESAURIMENTO SCORTE

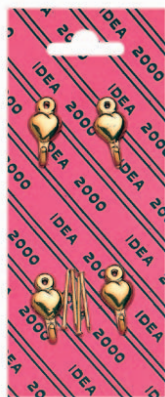

**art. 6.1650**

skin gancio cuore  
4 pezzi

|          |    |
|----------|----|
| FINITURA | OL |
| IMBALLO  | 25 |

DISPONIBILI FINO AD  
ESAURIMENTO SCORTE

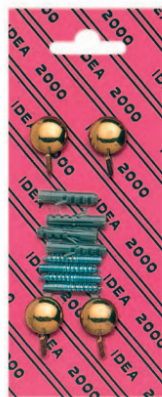

**art. 6.1660**

skin gancio bottoncino  
grande filettato - 4 pezzi

|          |        |
|----------|--------|
| FINITURA | Z. ORO |
| IMBALLO  | 25     |

DISPONIBILI FINO AD  
ESAURIMENTO SCORTE

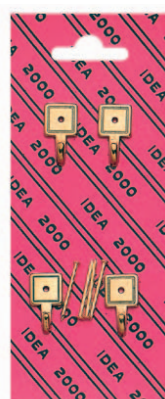

**art. 6.1670**

skin gancio quadro  
4 pezzi

|          |    |
|----------|----|
| FINITURA | OL |
| IMBALLO  | 25 |

DISPONIBILI FINO AD  
ESAURIMENTO SCORTE

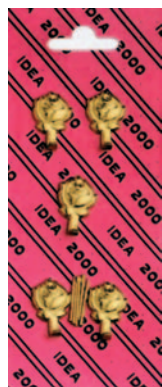

**art. 6.1690**

skin gancio rosa  
5 pezzi

|          |          |
|----------|----------|
| FINITURA | ACC. ORO |
| IMBALLO  | 25       |

DISPONIBILI FINO AD  
ESAURIMENTO SCORTE



**art. 7.4090**

skin catena di sicurezza  
1 pezzi

|          |     |
|----------|-----|
| FINITURA | OLV |
| IMBALLO  | 25  |

# ESPOSITORI



**art. 9.8050**

armadio espositore  
profondità 51 cm  
altezza 190 cm  
fronte 133 cm

pannello apribile  
per scorte di prodotti



**art. 9.8000**

espositore girevole



**Art. 9.0070**  
Gioco gratz fori  
50 pezzi

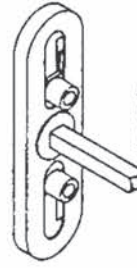

**Art. 9.0095**  
Gioco gratz bussole +  $\varnothing 7$   
50 pezzi

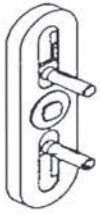

**Art. 9.0080**  
Gioco gratz perni  
50 pezzi

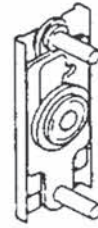

**Art. 9.0120**  
Gioco MP  
50 pezzi

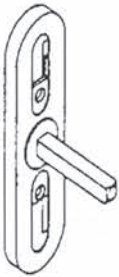

**Art. 9.0075**  
Gioco gratz fori +  $\varnothing 7$   
50 pezzi

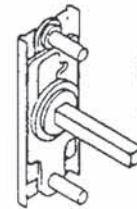

**Art. 9.0125**  
Gioco MP +  $\varnothing 7$   
50 pezzi

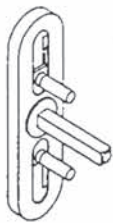

**Art. 9.0085**  
Gioco gratz perni +  $\varnothing 7$   
50 pezzi

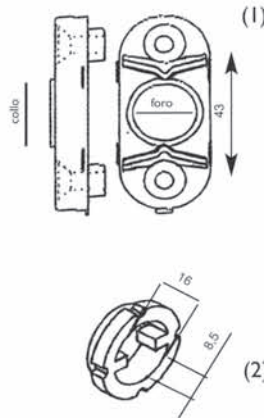

**Art. 9.0062**  
Movimento DK speciale con viti  
(movimento (1) + rotore (2) che è quello  
che fa scattare il movimento)



**Art. 9.0090**  
Gioco gratz bussole  
50 pezzi

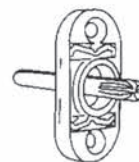

**Art. 9.0060**  
Movimento DK ovale  $\varnothing 7 \times 45$  nylon  
50 pezzi

**Art. 9.0065**  
Giov DK ovale  $\varnothing 7 \times 45$  Acciaio ottone  
50 pezzi



**Art. 9.0135**  
Piastrina con  $\square$  8 base quadrata  
50 pezzi



**Art. 9.0140**  
Piastrina con filetto 8 MA base tonda  
50 pezzi



**Art. 9.0786**  
Vite per giunzione 4 ma conf. pz. 100  
Vite per giunzione 6 ma conf. pz. 100  
Vite per giunzione 8 ma conf. pz. 100



**Art. 9.0781**  
Vite 4 ma x 20 conf. pz. 500  
Vite 4 ma x 25 conf. pz. 500  
Vite 4 ma x 30 conf. pz. 500  
Vite 4 ma x 40 conf. pz. 500



**Art. 9.0782**  
Vite 4 ma x 40 pretagliata conf. pz. 100  
Vite 4 ma x 50 pretagliata conf. pz. 100



**Art. 9.0785**  
Confezione 2 pezzi vite per copr. Magic 3,5x9,5

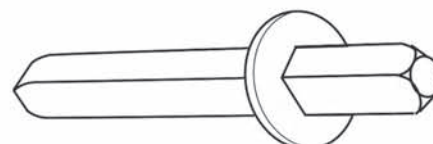

**Art. 9.0045**  
Ferro  $\square$  7 con rondella per martelline conf. pz. 50



**Art. 9.0784**  
Confezione 2 pezzi vite per copr. Vimar 3x9



**Art. 9.0200**  
Ferro quadro 6x100 100 pezzi  
Ferro quadro 7x 75 100 pezzi  
Ferro quadro 7x100 100 pezzi  
Ferro quadro 8x120 100 pezzi  
Ferro quadro 8x140 100 pezzi



**Art. 9.0203**  
Ferro tagliato e fresato I lato con rondella in testa  
 $\square$  8x80 100 pezzi



**Art. 9.0201**  
Ferro fresato  $\square$  8x90 100 pezzi  
Ferro fresato  $\square$  8x100 100 pezzi  
Ferro fresato  $\square$  8x120 100 pezzi

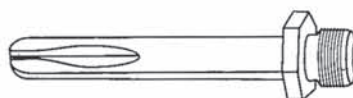

**Art. 9.0204**  
Ferro con nipples 10 MA  $\square$  8x90 20 pezzi  
Ferro con nipples 10 MA  $\square$  8x100 20 pezzi



**Art. 9.0202**  
Ferro ad espansione  $\square$  8x48 20 pezzi  
Ferro ad espansione  $\square$  8x55 20 pezzi  
Ferro ad espansione  $\square$  8x65 20 pezzi  
Ferro ad espansione  $\square$  8x80 20 pezzi

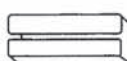

**Art. 9.0205**  
Riduzione plastica del 7 a 6 100 pezzi  
Riduzione plastica del 8 a 6 100 pezzi  
Riduzione plastica del 8 a 7 100 pezzi  
Riduzione plastica del 8 a 9 100 pezzi

# PLACCHE MANIGLIE



**cod. 10**  
placca per maniglie  
230x38 mm



**cod. 11**  
placca per maniglie  
240x42 mm



**cod. 12**  
placca per maniglie  
247x38 mm



**cod. 13**  
placca per maniglie  
246x39 mm



**cod. 14**  
placca per maniglie  
230x36 mm



**cod. 17**  
placca per maniglie  
232x28 mm



**cod. 18**  
placca per maniglie  
185x40 mm



**cod. 19**  
placca per maniglie  
224x35 mm



**cod. 22**  
placca per maniglie  
253x43 mm



**cod. 31**  
placca per maniglie  
252x39 mm



**art. 2.0008**  
placca "G" per maniglie  
280x50 mm



**art. 2.0007**  
placca "B" per maniglie  
270x55 mm



**cod. 2.0009**  
placca "K" per maniglie  
226x38 mm



# PLACCHE CREMONESI



**cod. 10**

placca per cremonesi o martellina  
175x38 mm



**cod. 11**

placca per cremonesi o martellina  
179x39 mm



**cod. 12**

placca per cremonesi o martellina  
179x39 mm



**cod. 19**

placca per cremonesi  
o martellina 160x37 mm



**art. 21**

placca per cremonesi  
o martellina 141x35 mm



**art. 22**

placca per cremonesi  
o martellina 164x38 mm



**cod. 31**

placca per cremonesi  
o martellina 180x39 mm



# ROSETTA



**cod. 60**

rosetta per dk ovale  
61x31 mm

# FINITURE



**CR** cromo lucido



**CRS** cromo satinato



**OLV** ottone lucido verniciato



**SAT** ottone satinato



**INOX** acciaio satinato



**PVD** pvd



**NIK MATT** nikel satinato



**OGR** bronzato sfumato graffiato



**OGR OP** bronzato sfumato graffiato opaco



**ANT** anticato verniciato



**ANT NV** anticato non verniciato



**ANT BL** anticato a macchie



**ORO ANT** oro anticato



**ORO VL** oro valenzano



**ORO** oro 24 k



**ARG ANT** argento anticato



**NIK NR** nikel nero



**FERRO RU** ferro ruggine



MANIGLIA DESTRA



MANIGLIA SINISTRA

**IMPORTO EXTRA DA AGGIUNGERE AL PREZZO LORDO PER LAVORAZIONI GALVANICHE**

|   | ORO/ANT | CR/CRS | ARG/ANT | PVD   |
|---|---------|--------|---------|-------|
| maniglia su placca - rosetta $\varnothing$ 45 mm - rosetta 3 fori (artistica) | 4,60    | 6,60   | 8,60    | 16,50 |
| maniglia su rosetta $\varnothing$ 50 mm                                       | 6,00    | 8,00   | 10,00   | 18,00 |
| maniglia su rosetta quadra 50x50 mm   | 6,00    | 8,00   | 10,00   | 18,00 |
| cremonese - martellina - dk - copriavvolgibile                                | 3,00    | 3,40   | 5,60    | 9,20  |
| pomolo  | 3,00    | 3,40   | 5,60    | 9,20  |
| battente  | 4,00    | 4,40   | 6,20    | 10,00 |
| maniglione  | 5,40    | 6,00   | 7,00    | 14,40 |

- Per praticità di presentazione tutte le foto riportate a catalogo rispondono alle finiture più versatili e comunque nella versione che a nostro giudizio risultano più confacenti.
  - Tutte le maniglie riportate a catalogo possono essere eseguite con tutti i modelli di rosette e placche nelle finiture riportate a pagina 282 del catalogo.
  - **COSTI E MODIFICHE:**  
a pagina 280-281 del catalogo sono illustrate tutte le versioni di placca disponibili.
  - **ROSETTE OVALI:**  
tutte le maniglie possono essere eseguite con rosetta ovale applicando una maggiorazione di Euro 2,00 (*DUE*) a guarnitura o coppia.
  - **ROSETTE AD AVVITARE:**  
tutte le maniglie possono essere eseguite con rosetta ad avvitare ø 45 mm Lux (*dove non riportate*) con una maggiorazione di EURO 10,00 (*DIECI*) o con rosetta ad avvitare ø 50 mm con una maggiorazione di EURO 8,00 (*OTTO*).
- N.B. l'importo delle maggiorazioni si intende lordo per coppia o guarnitura.
- Le finiture in SAT ottone satinato e OGR bronzato sfumato graffiato hanno lo stesso costo.
  - Le finiture in CR cromo lucido e CRS cromo satinato hanno lo stesso costo.
  - L'azienda si riserva a suo insindacabile giudizio qualsiasi modifica senza necessariamente dare alcuna informazione.



## CONDIZIONI di VENDITA

### **ORDINI:**

Gli ordini si intendono accettati all'approvazione Cottali.

### **PREZZI:**

Si intendono IVA esclusa e per merce franco fabbrica.

### **PAGAMENTI:**

Il pagamento delle fatture deve essere fatto direttamente alla ditta Cottali.  
Non sono accettate trattenute o arrotondamenti.  
In caso di ritardato pagamento verranno applicate spese ed interessi commerciali.

### **CONSEGNE:**

I termini di consegna sono da considerarsi non rigidi e salvo imprevisti.  
Il ritardato invio della merce per qualsiasi motivo non dà diritto ad indennizzi.  
Per motivi gestionali la ditta Cottali si riserva il diritto di invii frazionati.

### **SPEDIZIONI:**

La merce viaggia a rischio e pericolo del Committente anche se spedita in porto franco;  
eventuali reclami sono ritenuti validi solo se effettuati entro otto giorni dal ricevimento della merce.

### **RECLAMI:**

Trascorsi otto giorni dal ricevimento della merce, non verranno presi in considerazione.  
Eventuali restituzioni devono aver ricevuto l'approvazione della ditta Cottali.

### **SEDE LEGALE:**

Per qualsiasi controversia, sarà competente il Foro di Brescia.